

11001

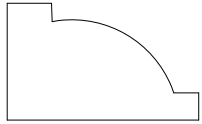

11041

EST. 1879

**S T A R K**

L U M B E R C O M P A N Y

FINE WOOD MOULDING

924 W. 1st. Avenue  
Denver, CO 80223  
303-534-8263 Phone  
303-534-8266 Fax

|              |          |           |             |
|--------------|----------|-----------|-------------|
| Approved by: | MM/DD/YY |           |             |
| Drawn:       |          |           |             |
| File name:   |          | Scale 1:1 | Sheet 1-1-1 |

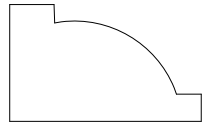

11041

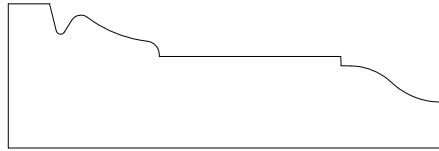

12001

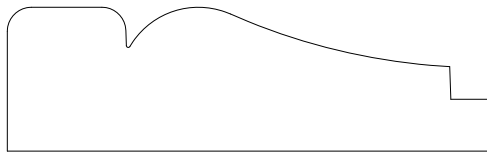

12002

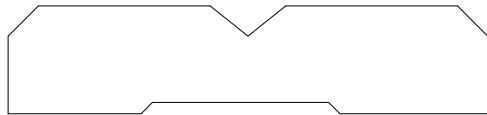

12003

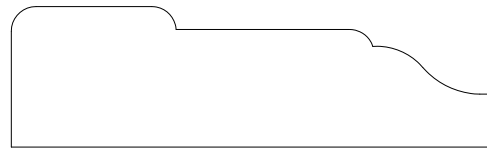

12004

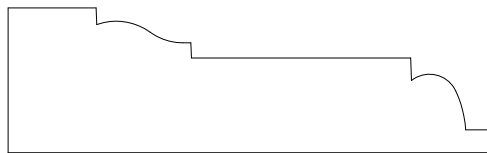

12005

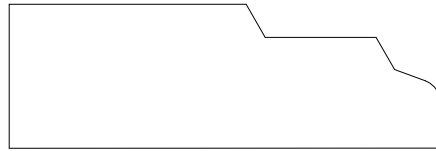

12006

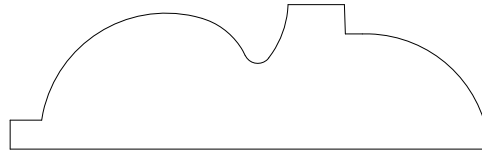

12007

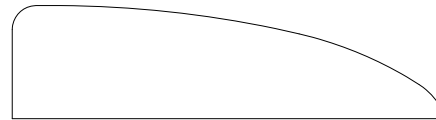

12008

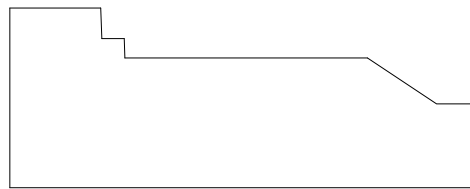

12009

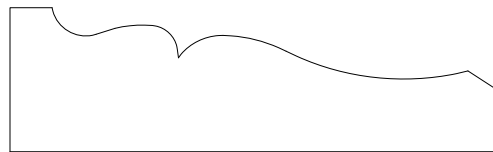

12010



12011

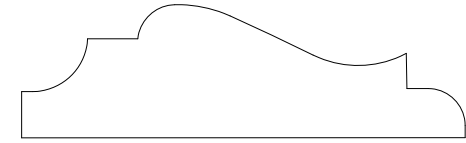

12012

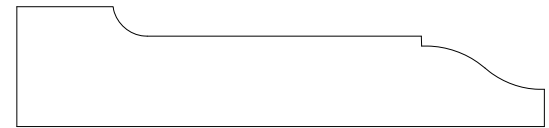

12013



12014

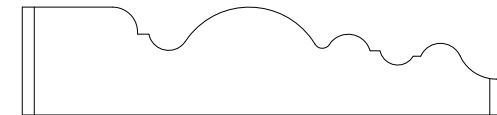

12015

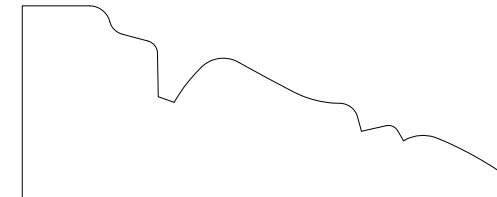

12016

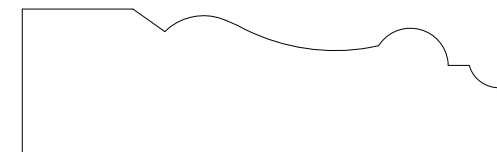

12017

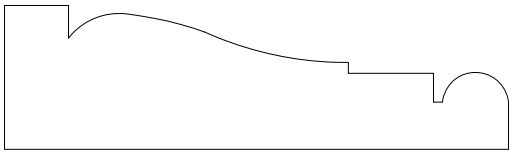

12018



12023

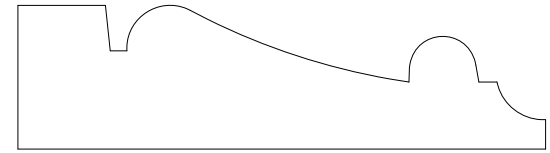

12028

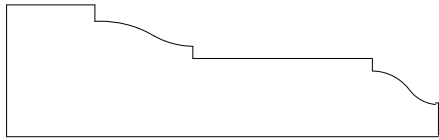

12019

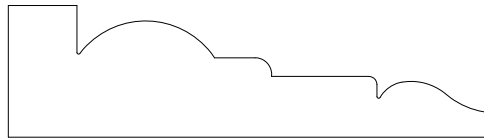

12024

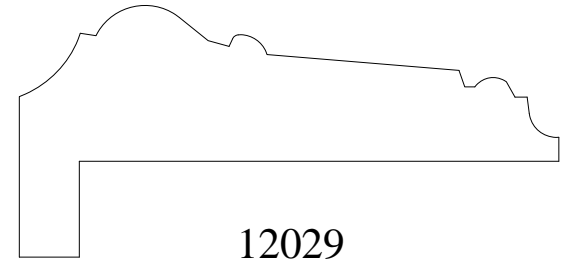

12029

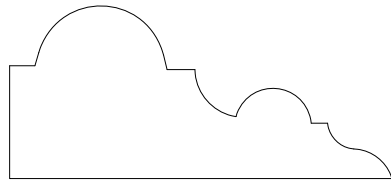

12020

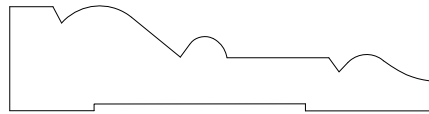

12025



12030

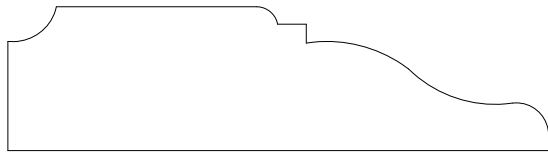

12021

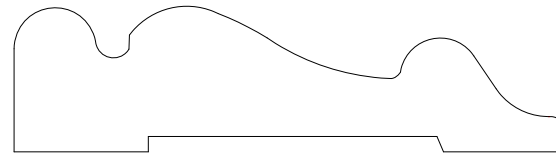

12026

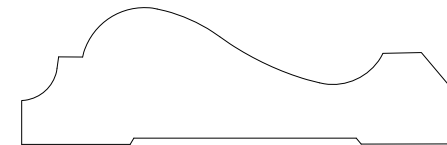

12031

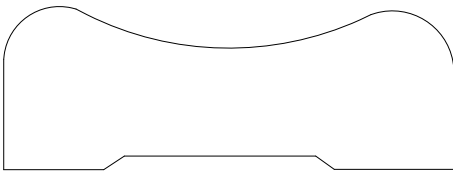

12022

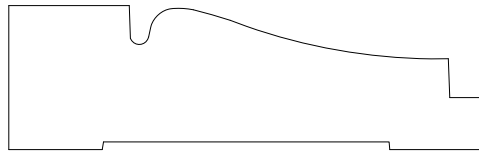

12027

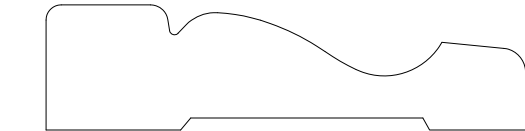

12032



EST. 1879  
924 W. 1st. Avenue  
Denver, CO 80223  
303-534-8263 Phone  
303-534-8266 Fax

|              |          |           |             |
|--------------|----------|-----------|-------------|
| Approved by: | MM/DD/YY |           |             |
| Drawn:       |          |           |             |
| File name:   |          | Scale 1:1 | Sheet 1-2-2 |

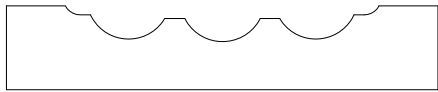

12033

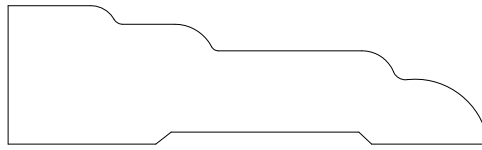

12039

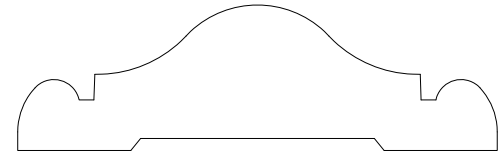

12045

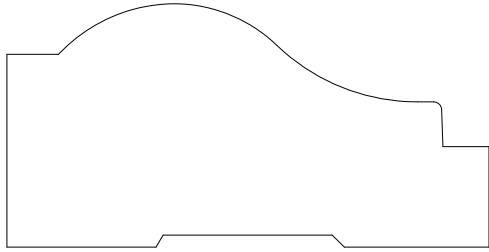

12034

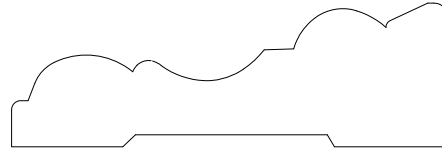

12040

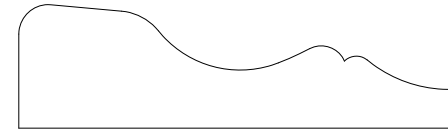

12046

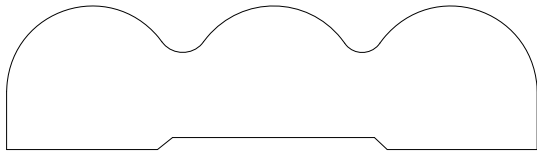

12035

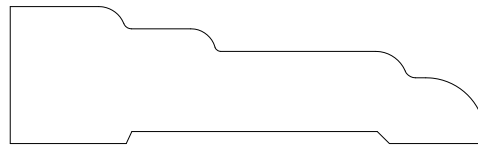

12041

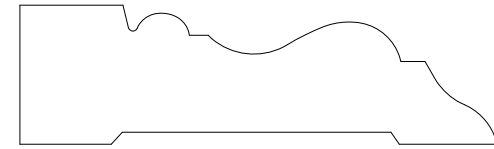

12047

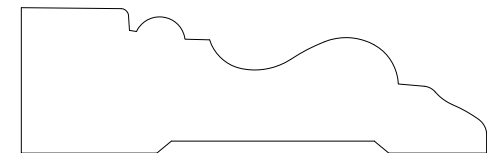

12036

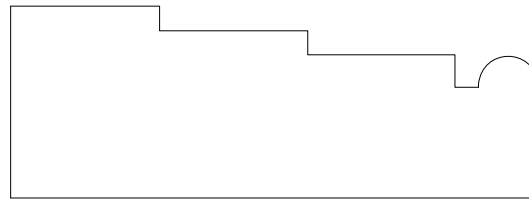

12042

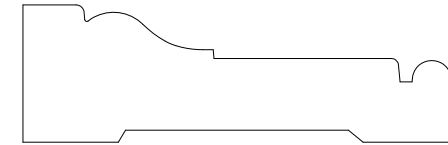

12048

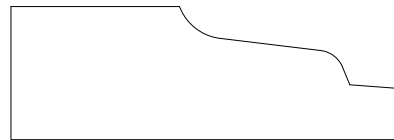

12037

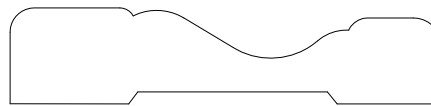

12043

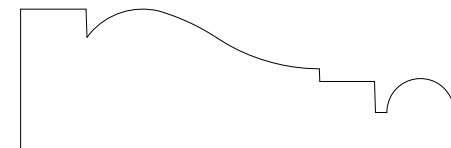

12049

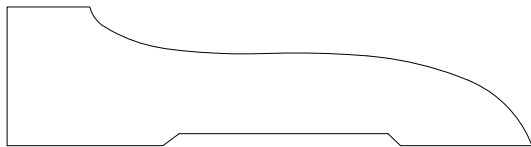

12038

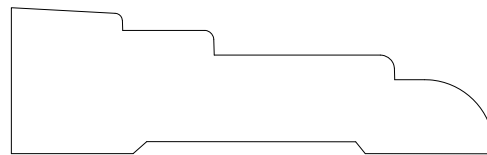

12044

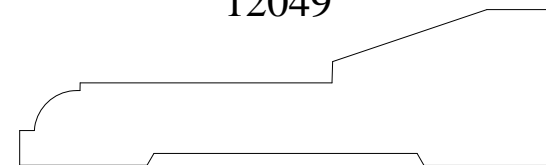

12050

EST. 1879

**S T A R K**

L U M B E R C O M P A N Y

FINE WOOD MOULDING

924 W. 1st. Avenue  
 Denver, CO 80223  
 303-534-8263 Phone  
 303-534-8266 Fax

|              |          |           |             |
|--------------|----------|-----------|-------------|
| Approved by: | MM/DD/YY |           |             |
| Drawn:       |          |           |             |
| File name:   |          | Scale 1:1 | Sheet 1-2-3 |

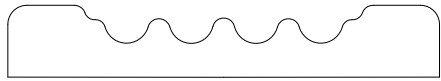

12051

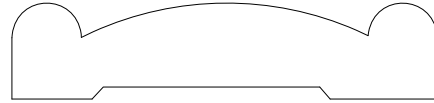

12057

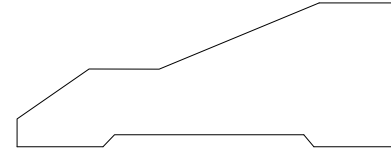

12063

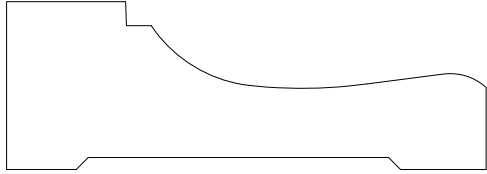

12052

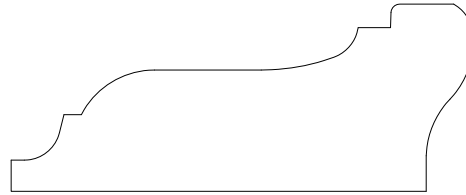

12058

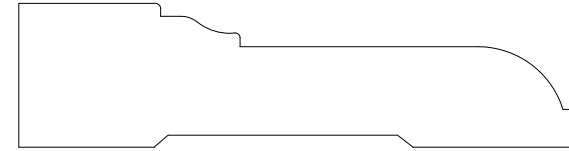

12064

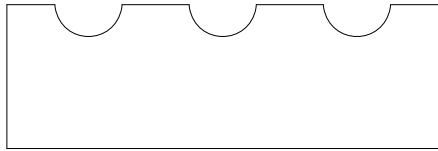

12053



12059

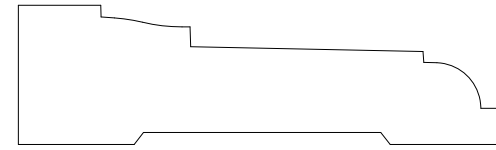

12065

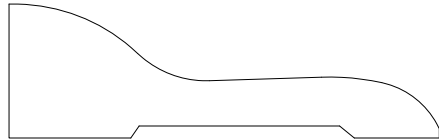

12054

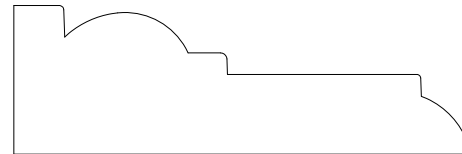

12060

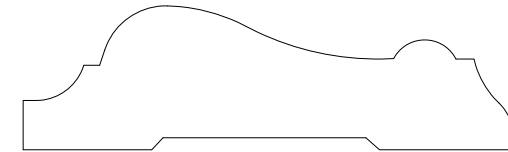

12066

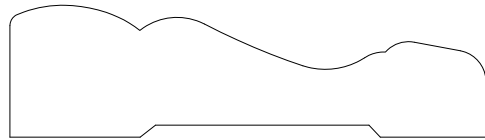

12055

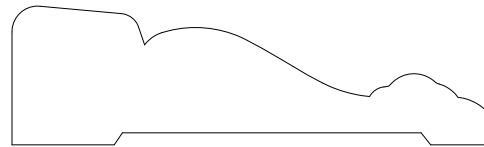

12061

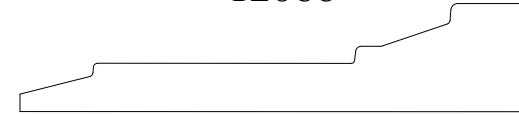

12067

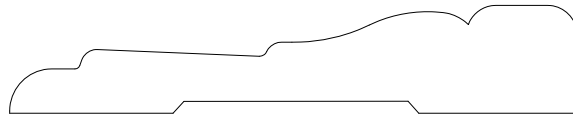

12056

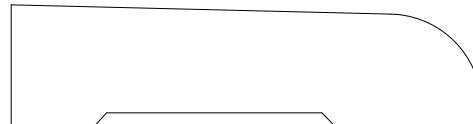

12062



12068

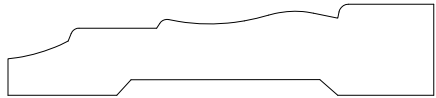

12069

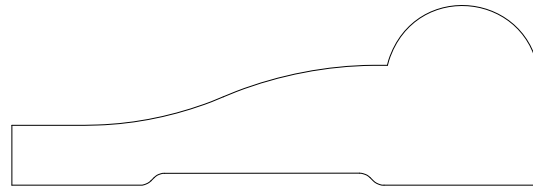

12075

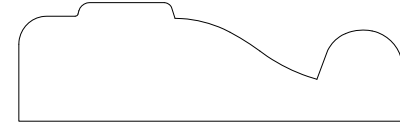

12081

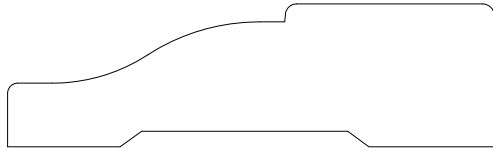

12070

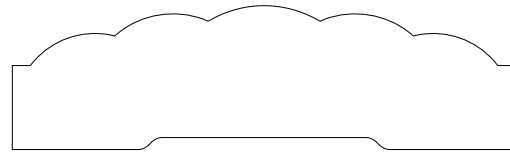

12076

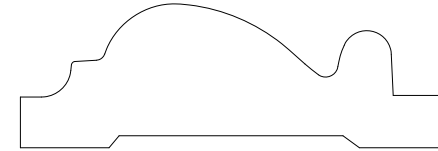

12082

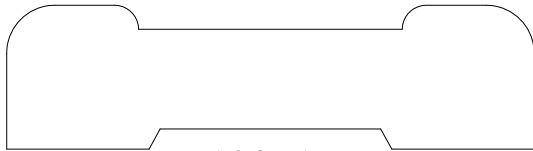

12071

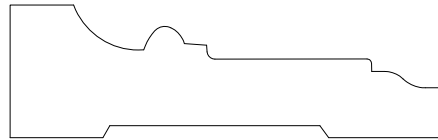

12077

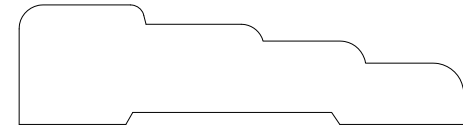

12083

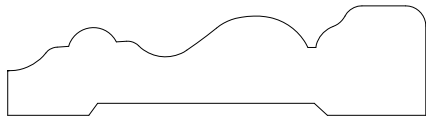

12072

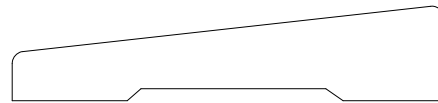

12078

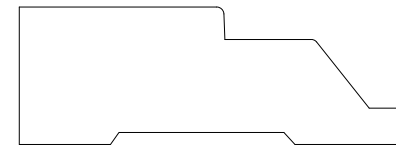

12084

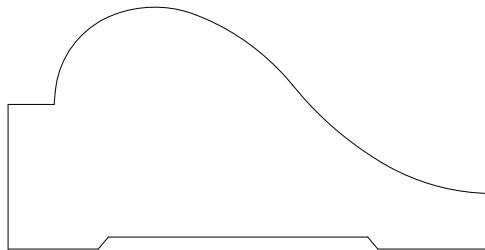

12073

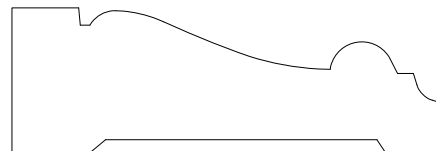

12079

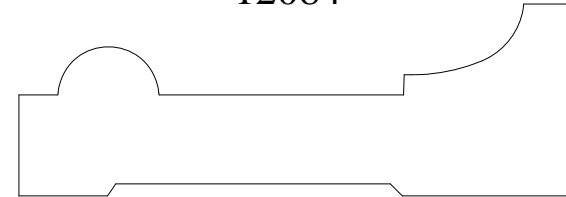

12085

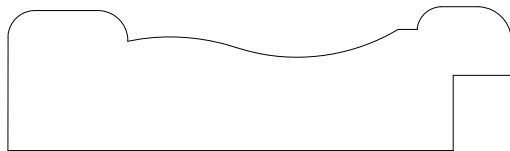

12074

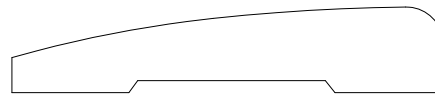

12080

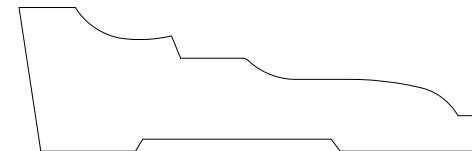

12086



924 W. 1st. Avenue  
Denver, CO 80223  
303-534-8263 Phone  
303-534-8266 Fax

Approved by:

MM/DD/YY

Drawn:

File name:

Scale 1:1

Sheet 1-2-5

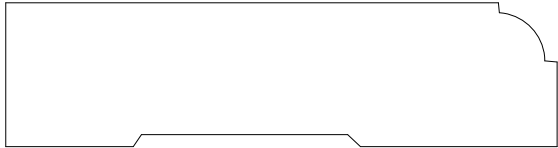

12087

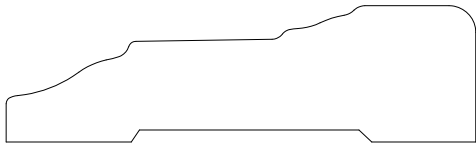

12088

|   |   |
|---|---|
| <p>EST. 1879</p> <p><b>S T A R K</b></p> <p>L U M B E R C O M P A N Y</p> <p>FINE WOOD MOULDING</p> | <p>924 W. 1st. Avenue<br/>         Denver, CO 80223<br/>         303-534-8263 Phone<br/>         303-534-8266 Fax</p> |
|---|---|

|              |          |           |             |
|--------------|----------|-----------|-------------|
| Approved by: | MM/DD/YY |           |             |
| Drawn:       |          |           |             |
| File name:   |          | Scale 1:1 | Sheet 1-2-6 |

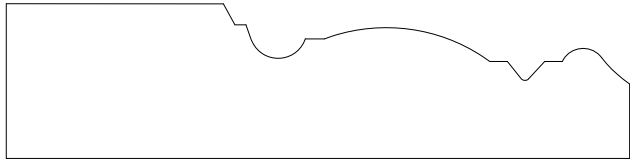

13001

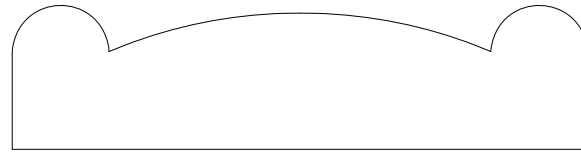

13006



13002

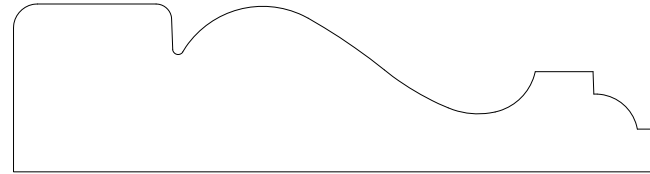

13007

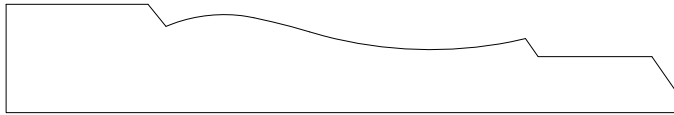

13003

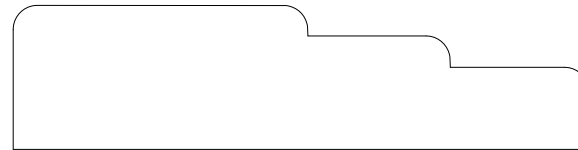

13008

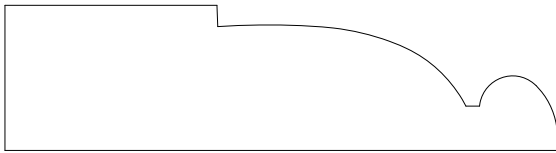

13004

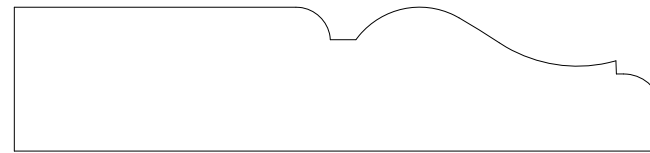

13009

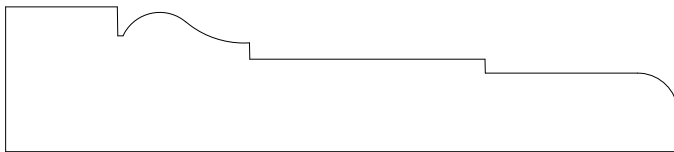

13005

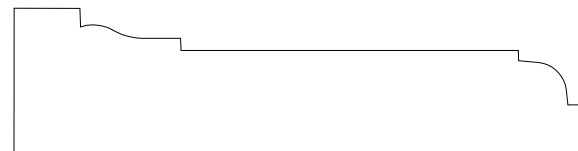

13010



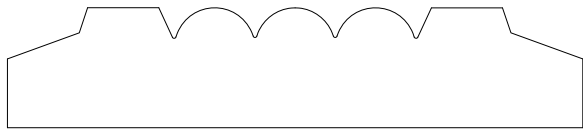

13011

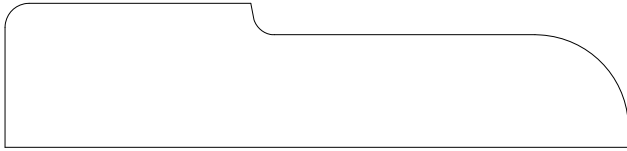

13012

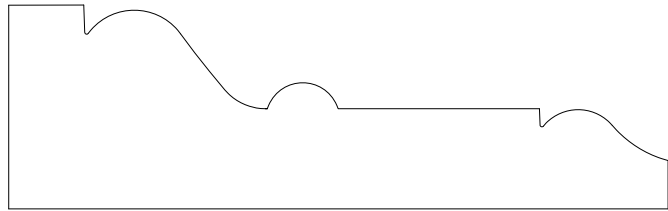

13013

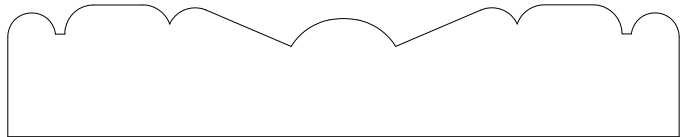

13014

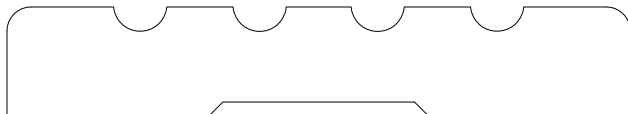

13015

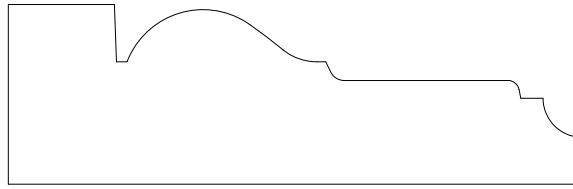

13016

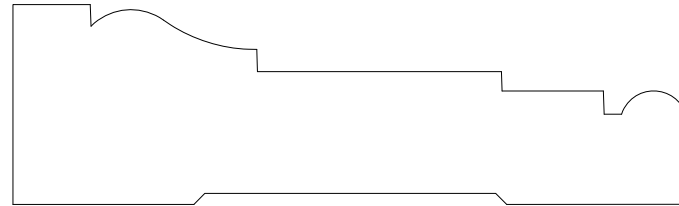

13017

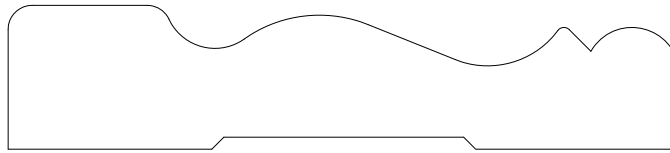

13018

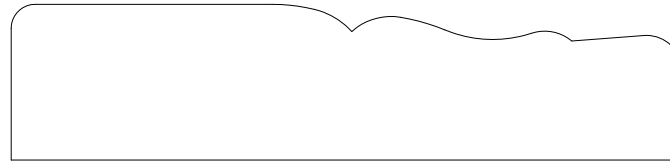

13019

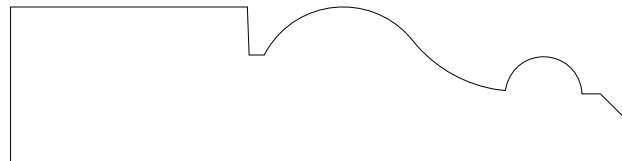

13020

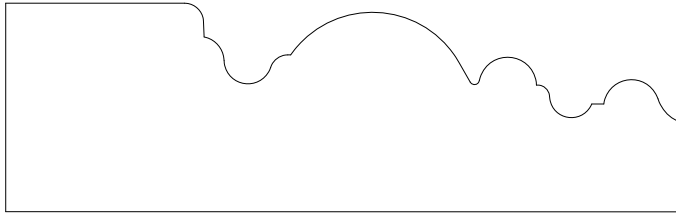

13021

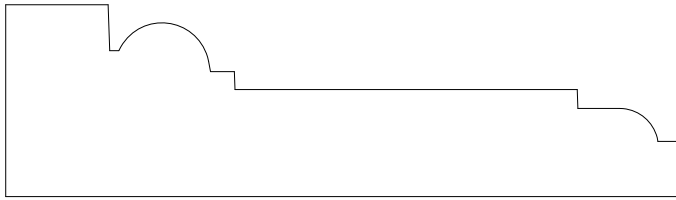

13022

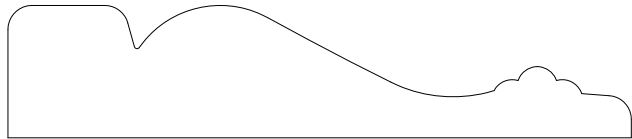

13023

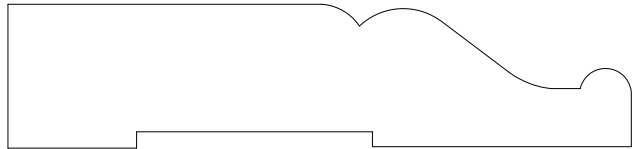

13024

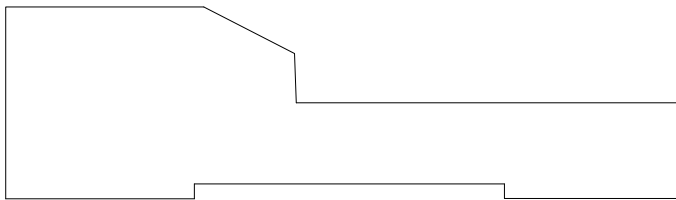

13025

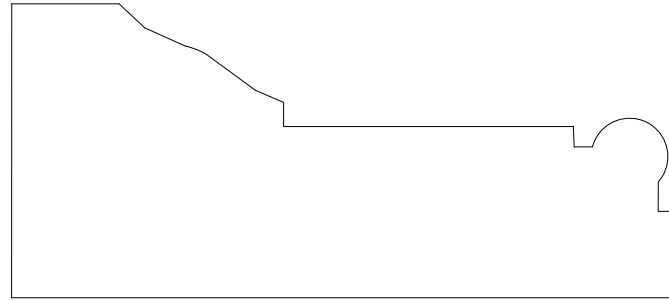

13026

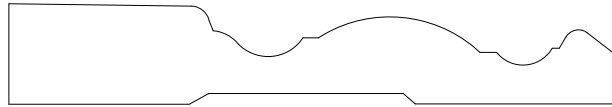

13027

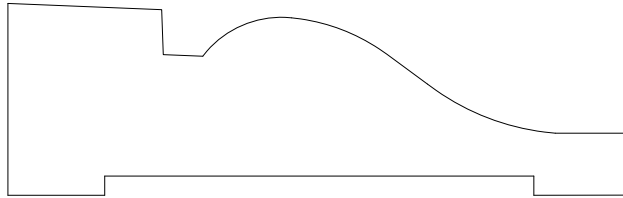

13028

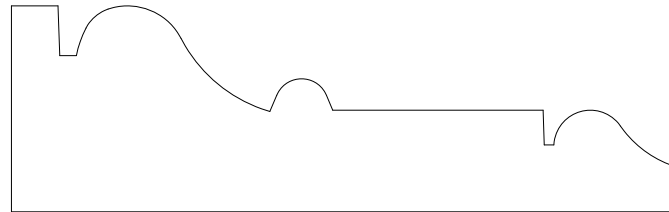

13029

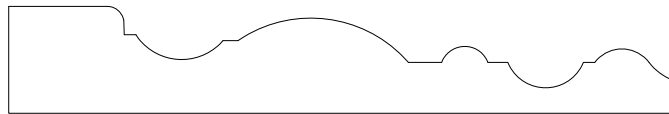

13030

EST. 1879

**S T A R K**

L U M B E R C O M P A N Y

FINE WOOD MOULDING

924 W. 1st. Avenue  
 Denver, CO 80223  
 303-534-8263 Phone  
 303-534-8266 Fax

|              |          |             |
|--------------|----------|-------------|
| Approved by: | MM/DD/YY |             |
| Drawn:       |          |             |
| File name:   |          | Scale 1:1   |
|              |          | Sheet 1-3-3 |

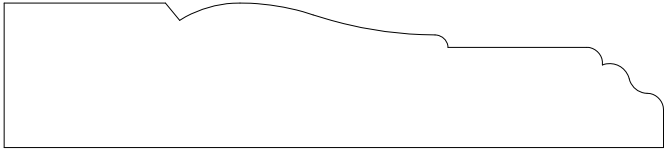

13031

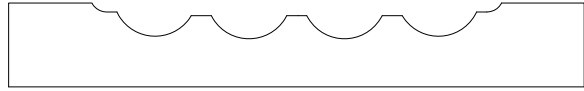

13032

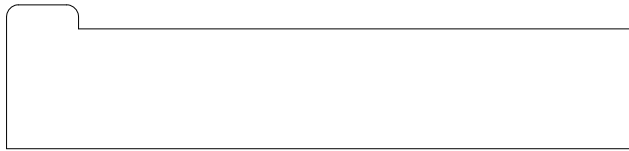

13033

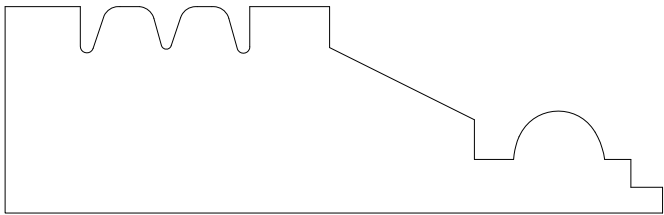

13034

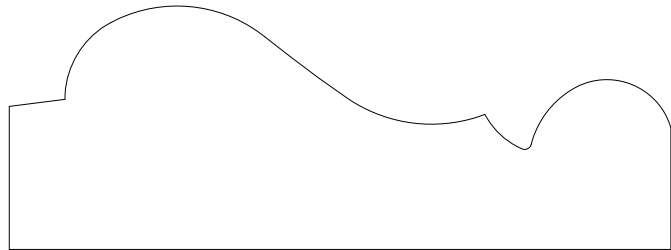

13035

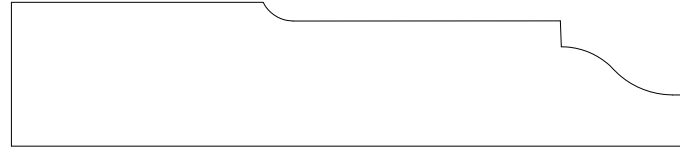

13036



13037



13038

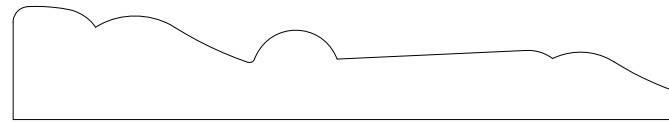

13039



13040

EST. 1879

**S T A R K**

L U M B E R C O M P A N Y

FINE WOOD MOULDING

924 W. 1st. Avenue  
 Denver, CO 80223  
 303-534-8263 Phone  
 303-534-8266 Fax

|              |          |             |
|--------------|----------|-------------|
| Approved by: | MM/DD/YY |             |
| Drawn:       |          |             |
| File name:   |          | Scale 1:1   |
|              |          | Sheet 1-3-4 |

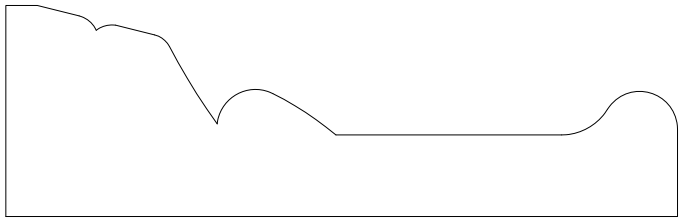

13041

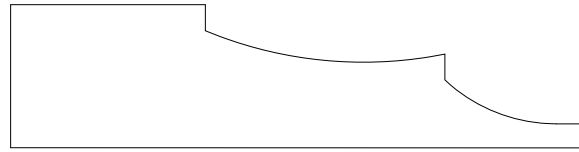

13045

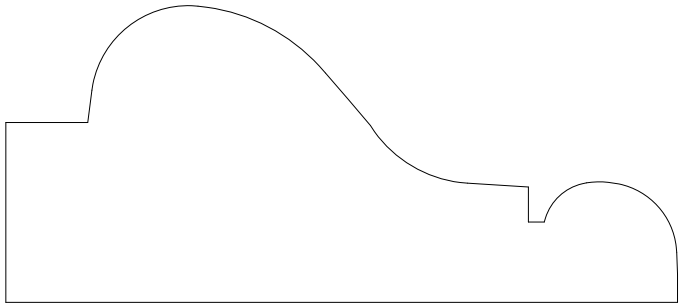

13042



13046



13047

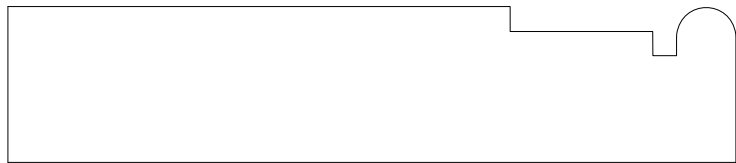

13043

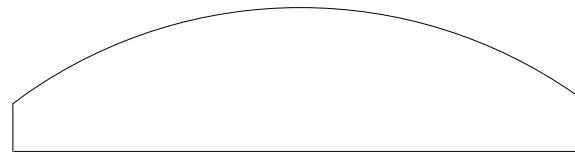

13048

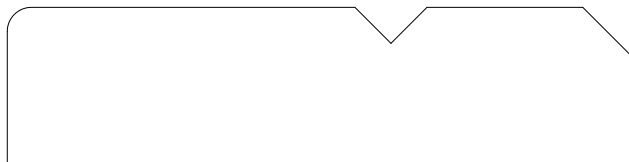

13044



13049

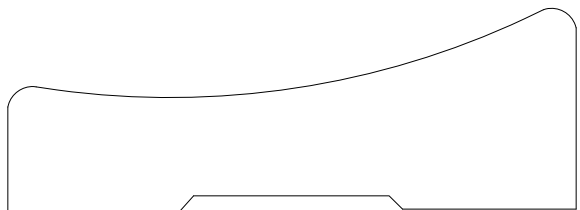

13050

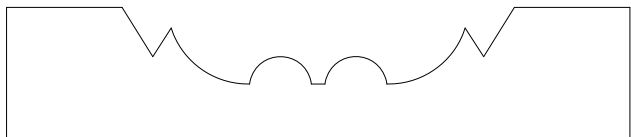

13051

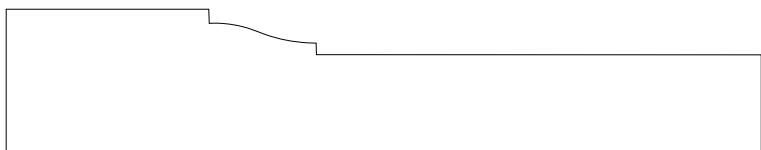

13052

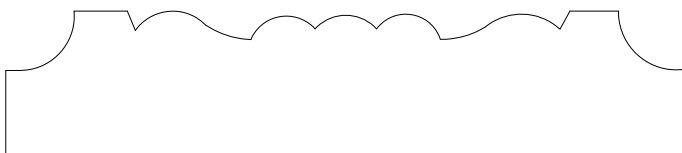

13053



13054

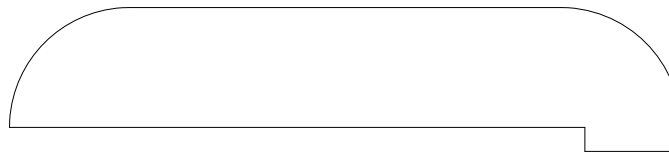

13055

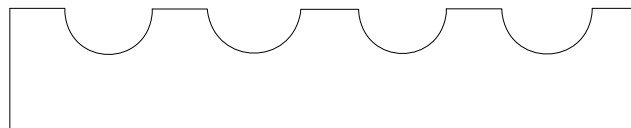

13056

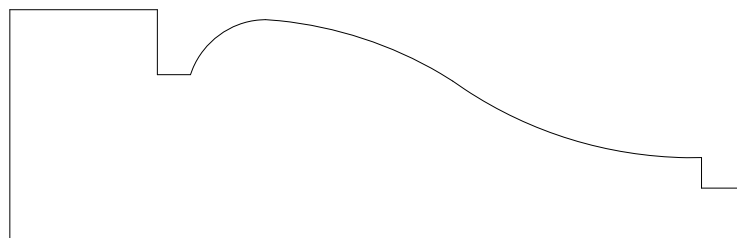

13057



13058

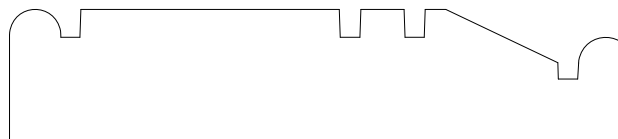

13059

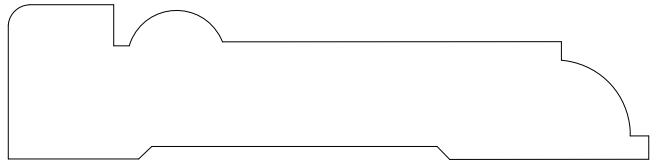

13060

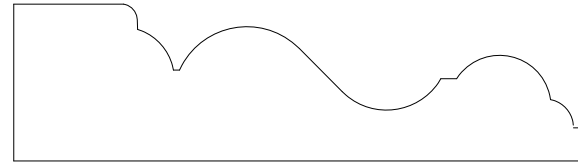

13065

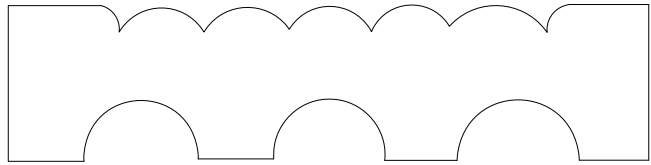

13061

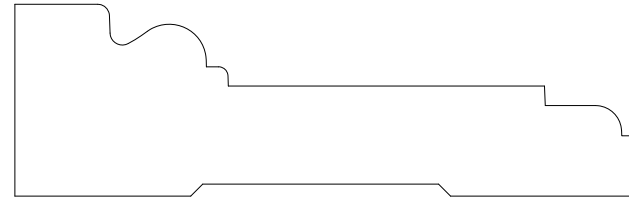

13066

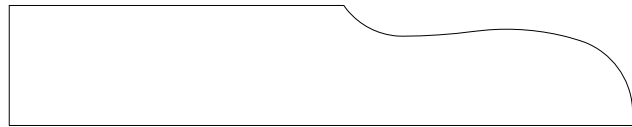

13062



13067

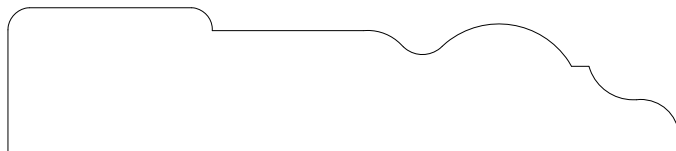

13063

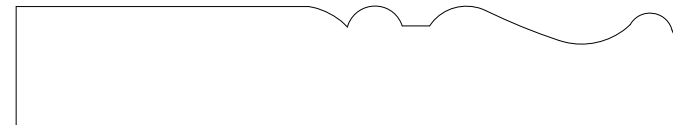

13068



13064

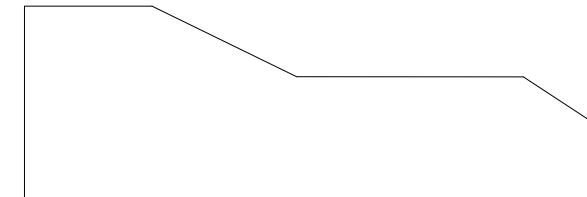

13069

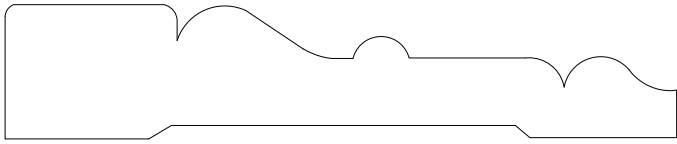

13070

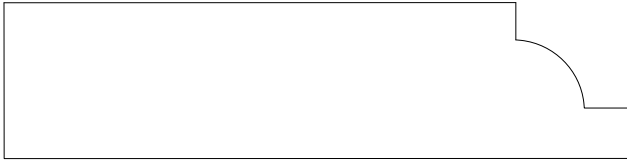

13071

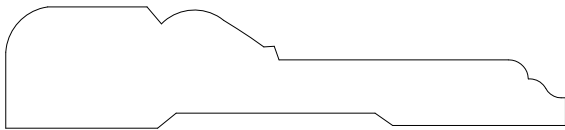

13072

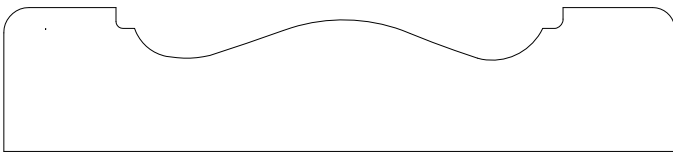

13073

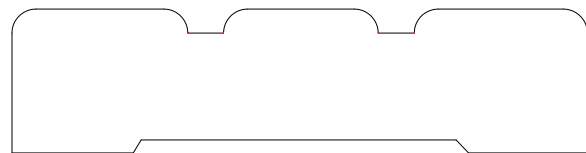

13074

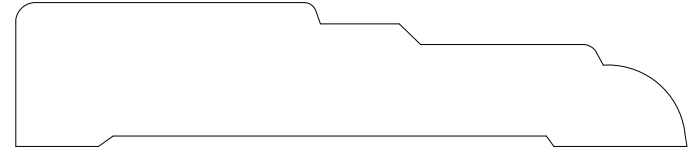

13075

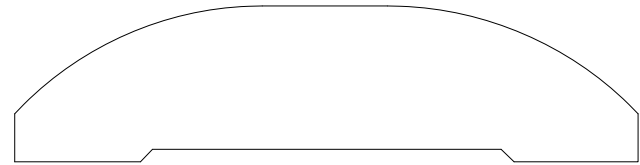

13076

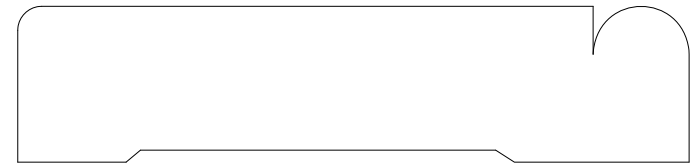

13077

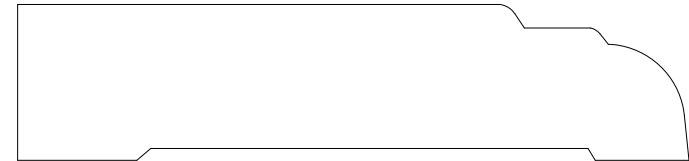

13078



13079

EST. 1879

**S T A R K**

L U M B E R C O M P A N Y

FINE WOOD MOULDING

924 W. 1st. Avenue  
 Denver, CO 80223  
 303-534-8263 Phone  
 303-534-8266 Fax

|              |          |           |             |
|--------------|----------|-----------|-------------|
| Approved by: | MM/DD/YY |           |             |
| Drawn:       |          |           |             |
| File name:   |          | Scale 1:1 | Sheet 1-3-8 |

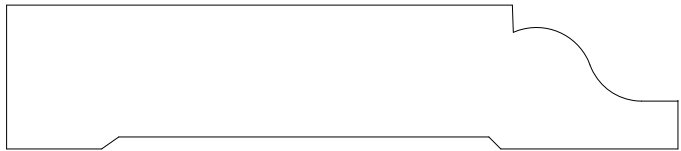

13080

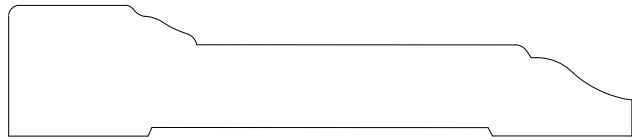

13081

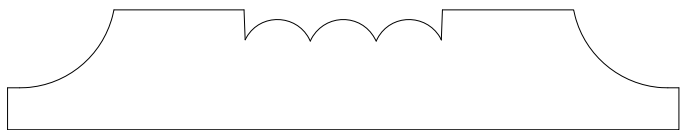

13082

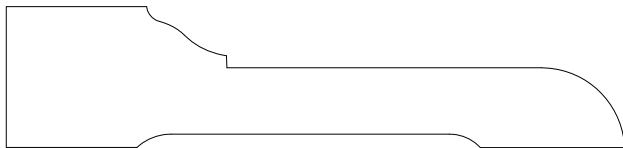

13083

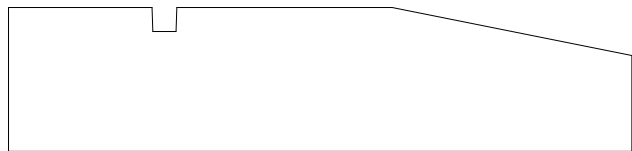

13084

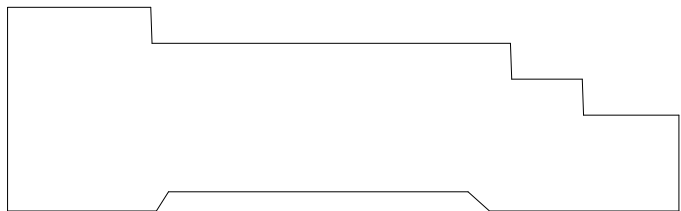

13085

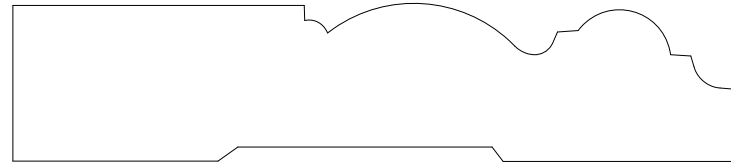

13086

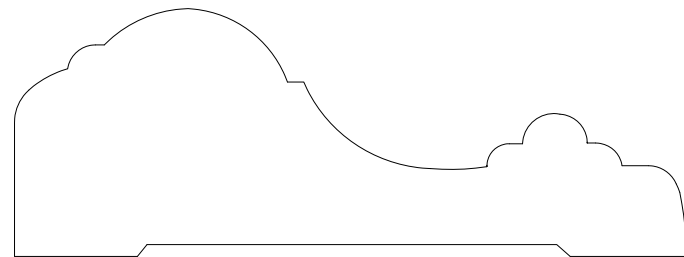

13087



13088

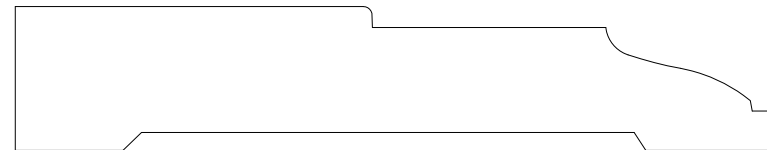

13089

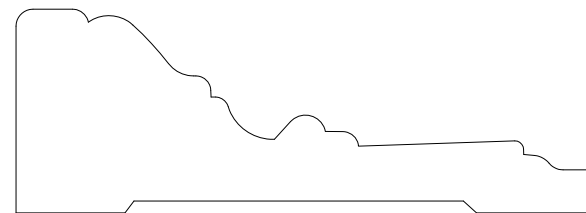

13090

|   |  |
|---|--|
|  <p>EST. 1879<br/><b>S T A R K</b><br/>L U M B E R C O M P A N Y<br/>FINE WOOD MOULDING</p> | <p>924 W. 1st. Avenue<br/>Denver, CO 80223<br/>303-534-8263 Phone<br/>303-534-8266 Fax</p> |
|---|--|

|              |          |           |             |
|--------------|----------|-----------|-------------|
| Approved by: | MM/DD/YY |           |             |
| Drawn:       |          |           |             |
| File name:   |          | Scale 1:1 | Sheet 1-3-9 |



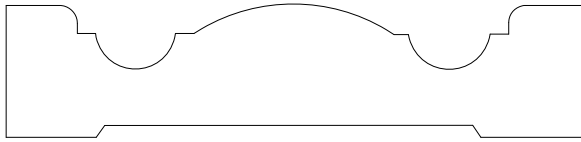

13091



13097



13092



13098

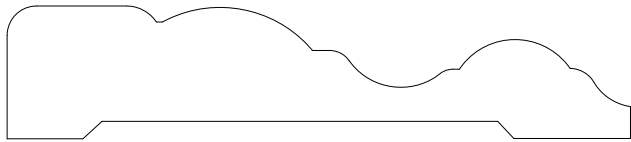

13093

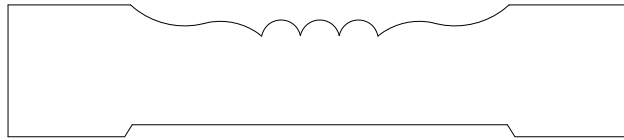

13099

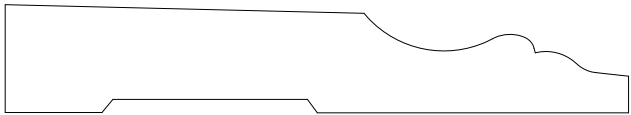

13094

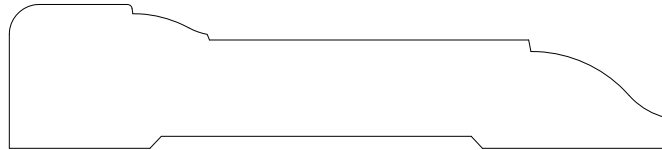

13100

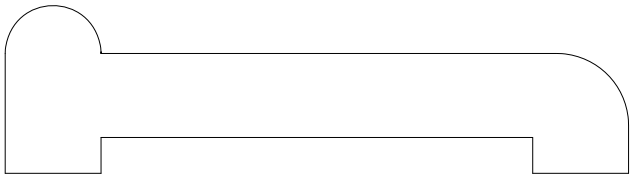

13095

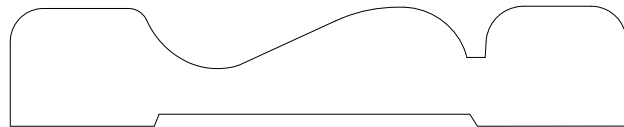

13101

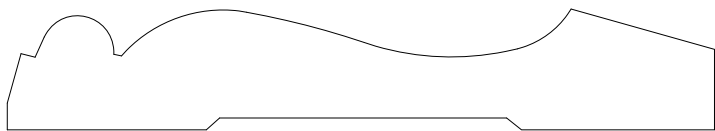

13096

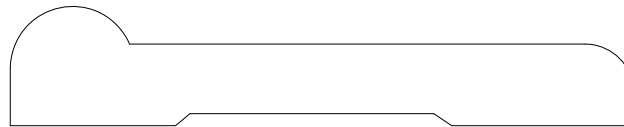

13102

|  |  |              |          |           |              |
|--|--|--------------|----------|-----------|--------------|
|  <p><b>S T A R K</b><br/>LUMBER COMPANY<br/>FINE WOOD MOULDING</p> | <p>924 W. 1st. Avenue<br/>Denver, CO 80223<br/>303-534-8263 Phone<br/>303-534-8266 Fax</p> | Approved by: | MM/DD/YY | Scale 1:1 | Sheet 1-3-10 |
|  |  | Drawn:       |          |           |              |
|  |  | File name:   |          |           |              |

|              |          |           |              |
|--------------|----------|-----------|--------------|
| Approved by: | MM/DD/YY | Scale 1:1 | Sheet 1-3-10 |
| Drawn:       |          |           |              |
| File name:   |          |           |              |

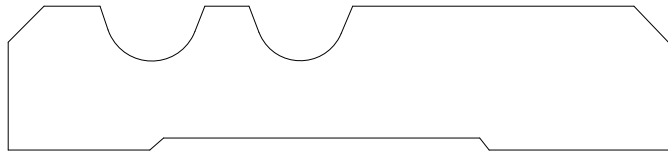

13103

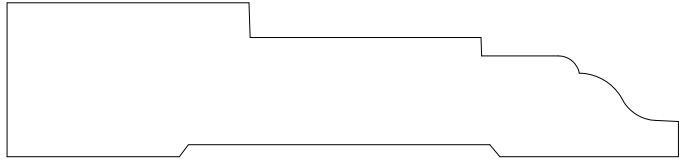

13104

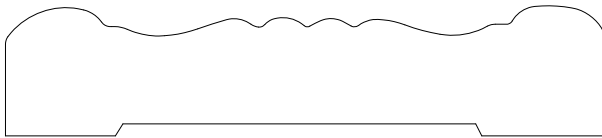

13105

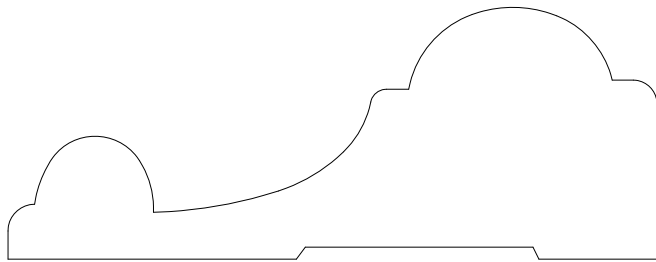

13106

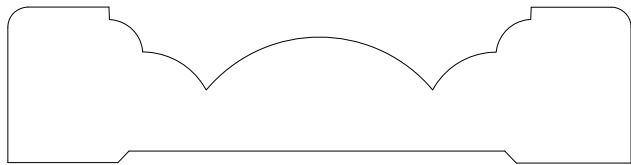

13107

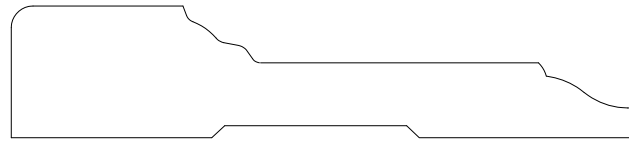

13108

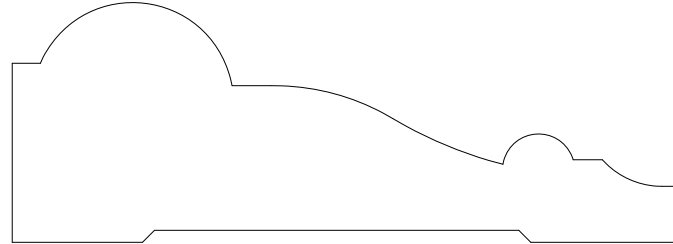

13109



13110

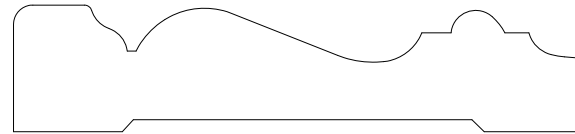

13111

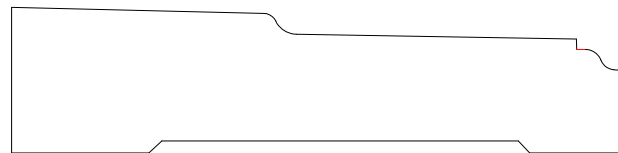

13112

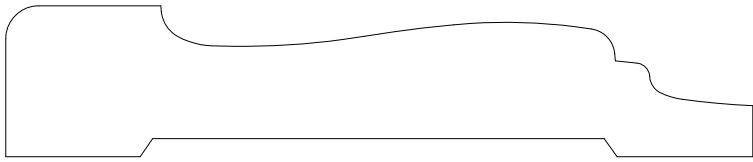

13113

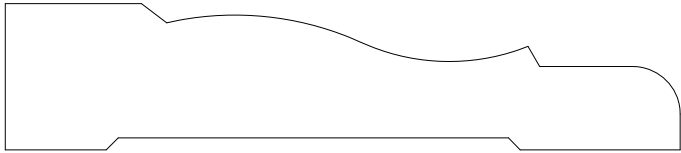

13114

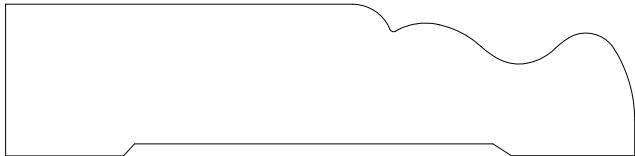

13115

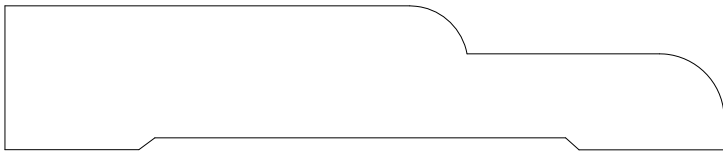

13116

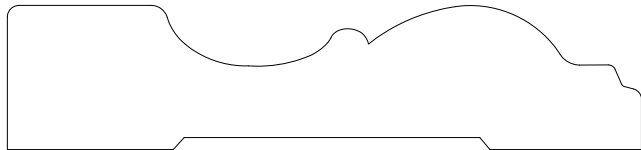

13117

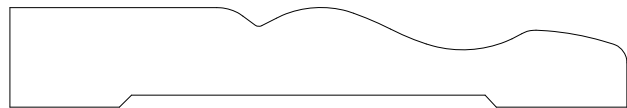

13118

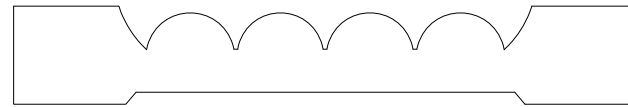

13119

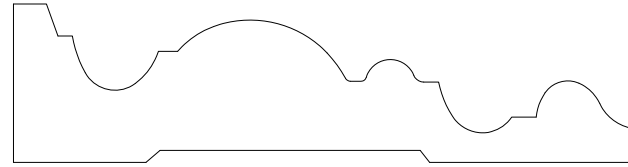

13120

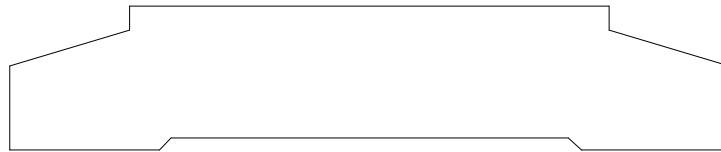

13121

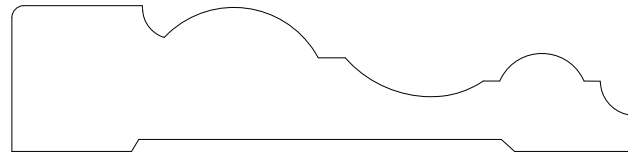

13122

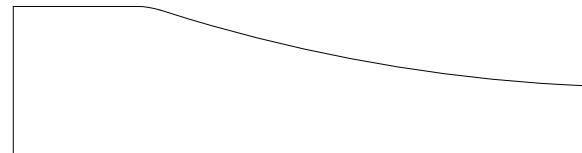

13123

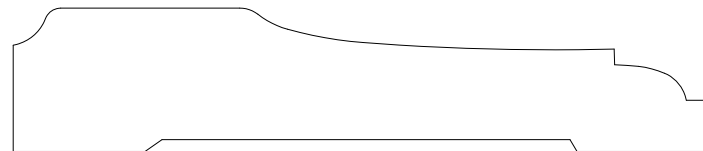

13124

|  |  |
|--|--|
|  | 924 W. 1st. Avenue<br>Denver, CO 80223<br>303-534-8263 Phone<br>303-534-8266 Fax |
|  |  |

|              |          |                        |
|--------------|----------|------------------------|
| Approved by: | MM/DD/YY |                        |
| Drawn:       |          |                        |
| File name:   |          | Scale 1:1 Sheet 1-3-12 |

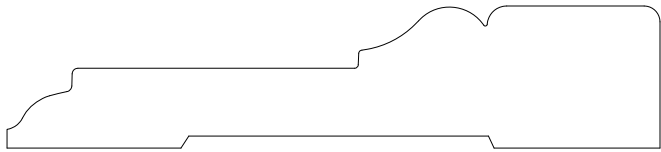

13125

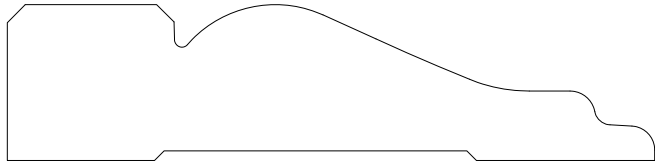

13126

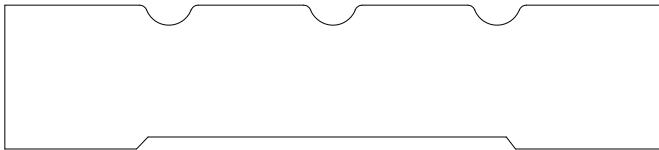

13127

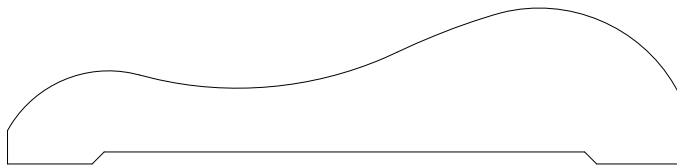

13128

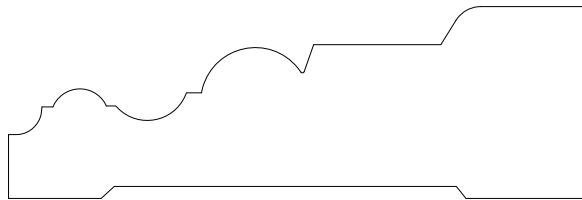

13129

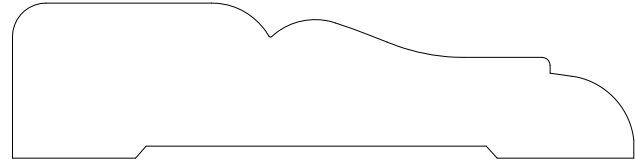

13130

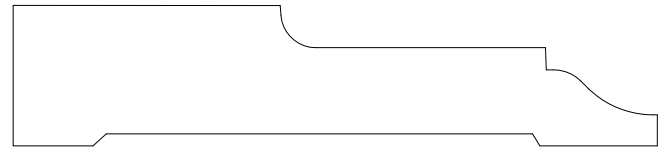

13131

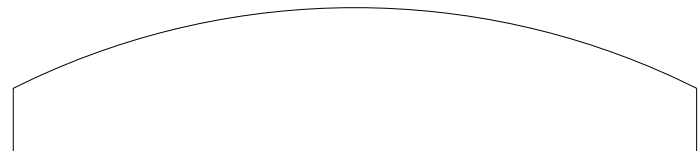

13132

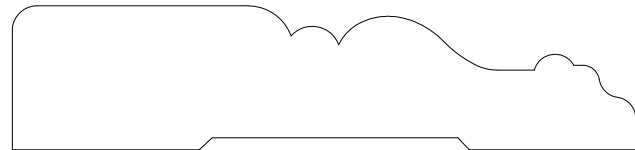

13133

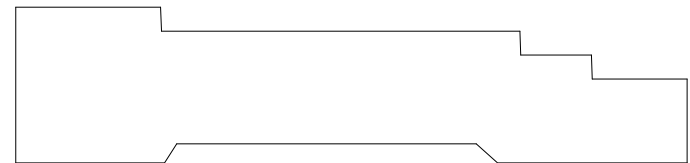

13134



13135

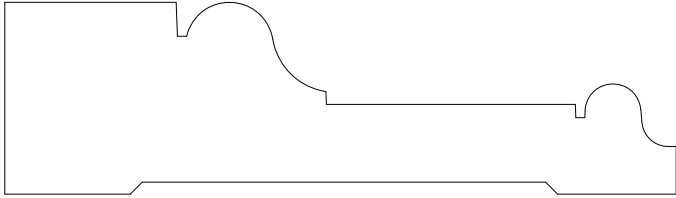

13136



13137

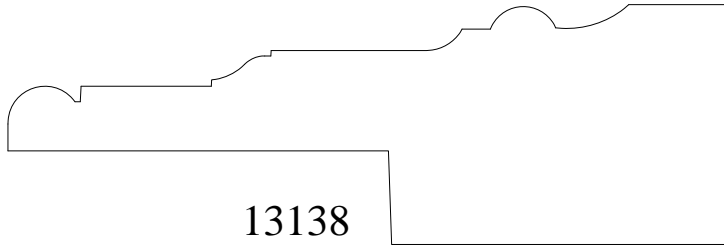

13138

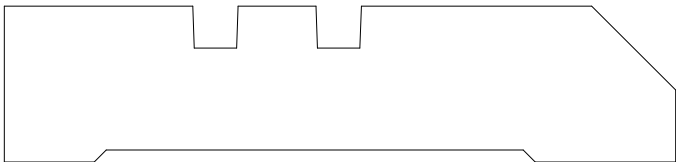

13139

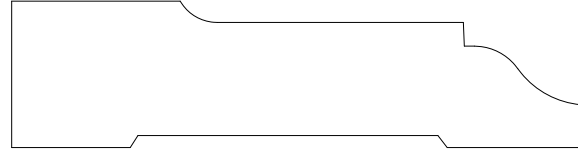

13140

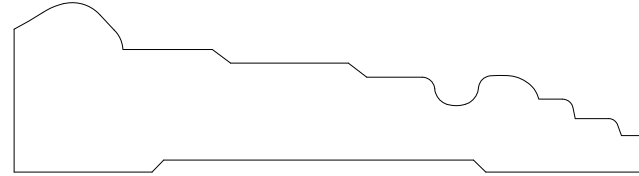

13141

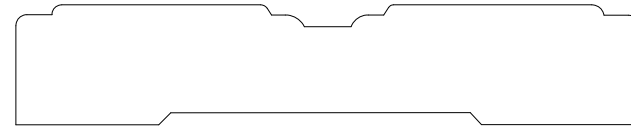

13142

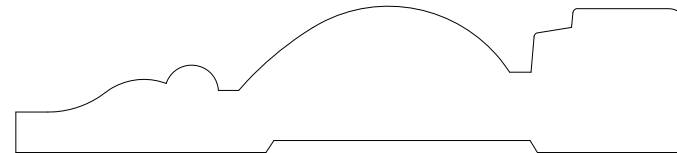

13143



13144

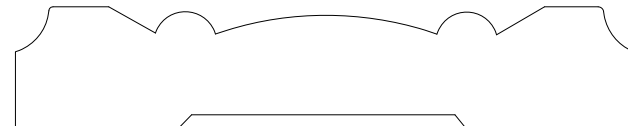

13145

EST. 1879

**S T A R K**

L U M B E R C O M P A N Y

FINE WOOD MOULDING

924 W. 1st. Avenue  
 Denver, CO 80223  
 303-534-8263 Phone  
 303-534-8266 Fax

|              |          |           |              |
|--------------|----------|-----------|--------------|
| Approved by: | MM/DD/YY |           |              |
| Drawn:       |          |           |              |
| File name:   |          | Scale 1:1 | Sheet 1-3-14 |

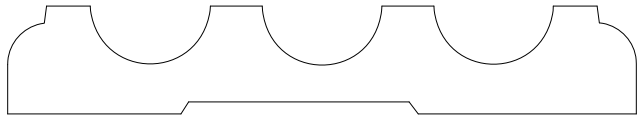

13146



13147

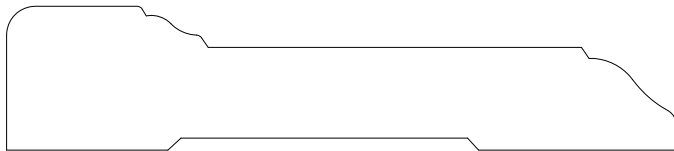

13148

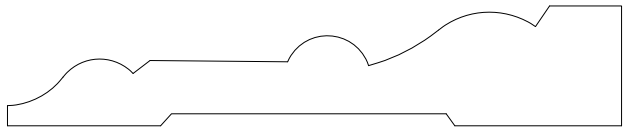

13149

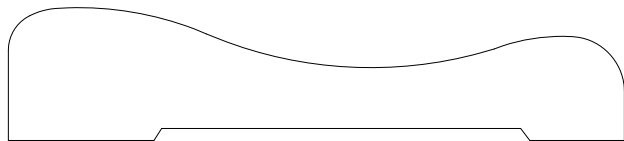

13150

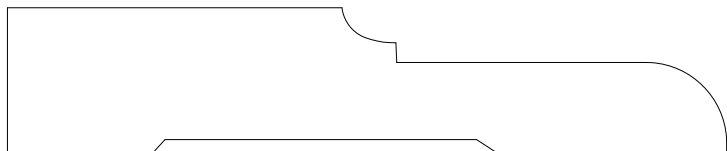

13152

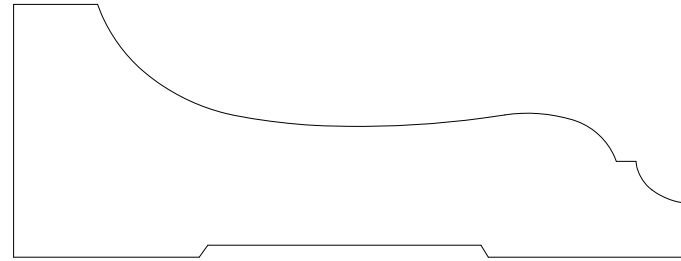

13151

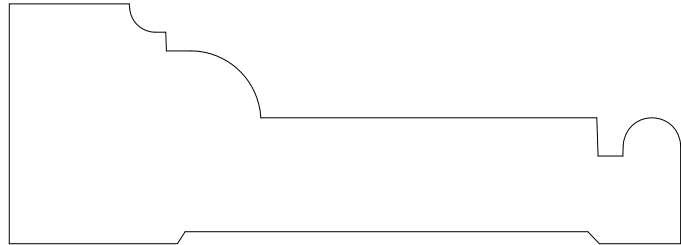

13153

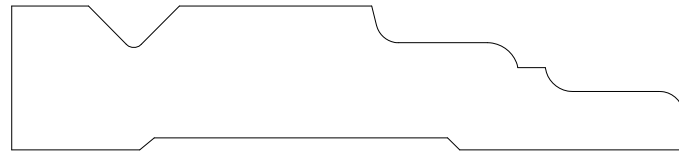

13154

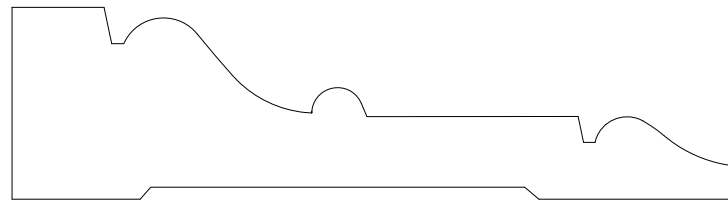

13155



13156

EST. 1879

**S T A R K**

L U M B E R C O M P A N Y

FINE WOOD MOULDING

924 W. 1st. Avenue  
 Denver, CO 80223  
 303-534-8263 Phone  
 303-534-8266 Fax

|              |          |           |              |
|--------------|----------|-----------|--------------|
| Approved by: | MM/DD/YY |           |              |
| Drawn:       |          |           |              |
| File name:   |          | Scale 1:1 | Sheet 1-3-15 |

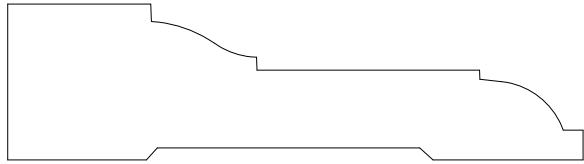

13157

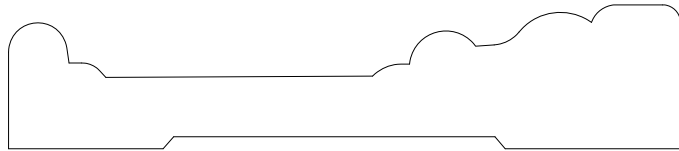

13158

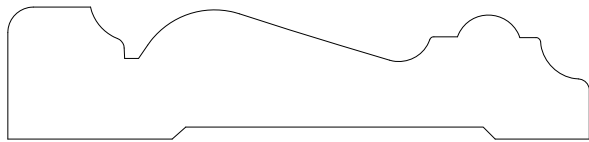

13159

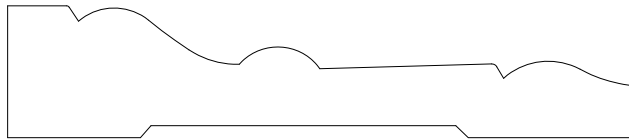

13160

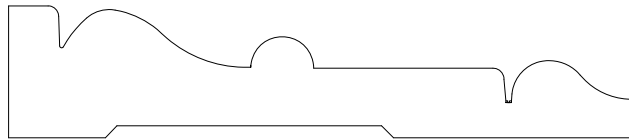

13161

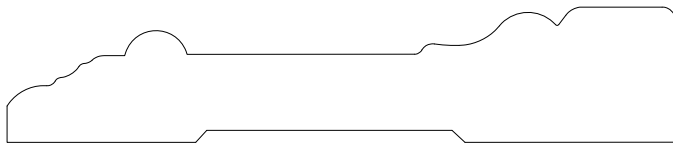

13162

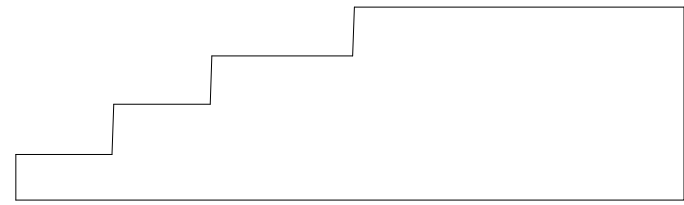

13163

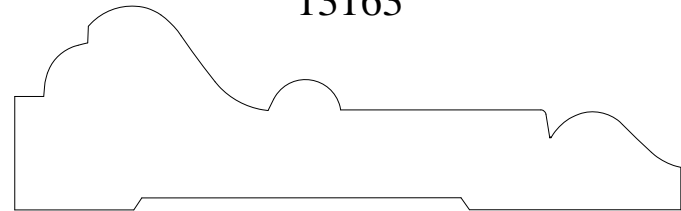

13164

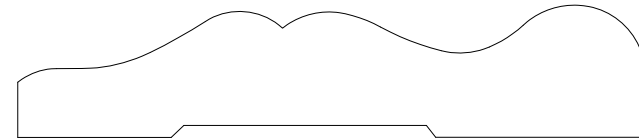

13165

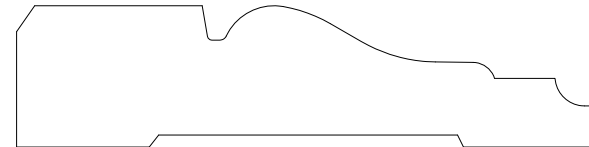

13166

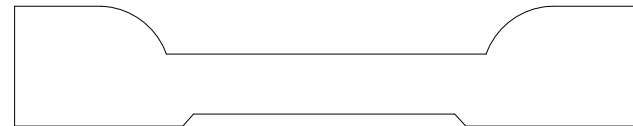

13167

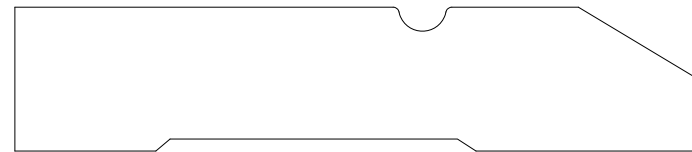

13168

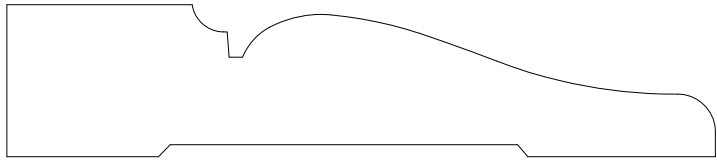

13169

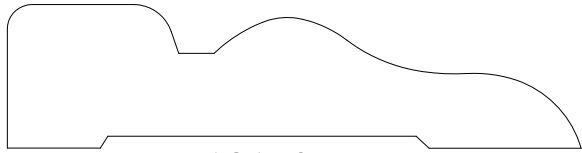

13170

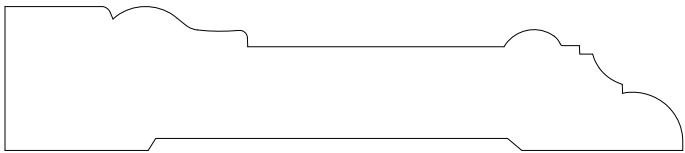

13171

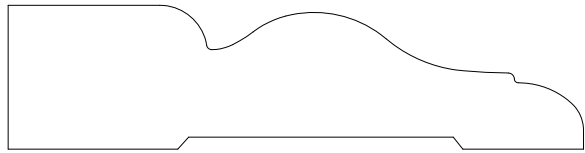

13172

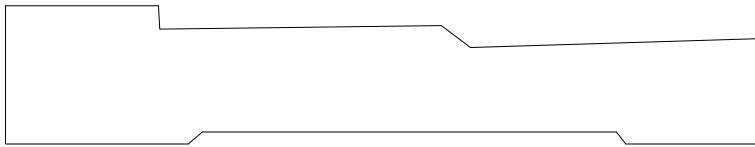

13173

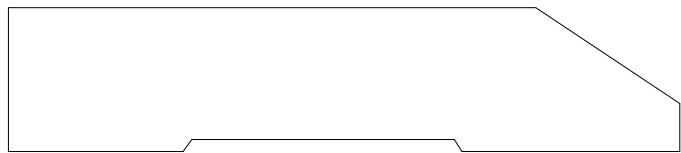

13174

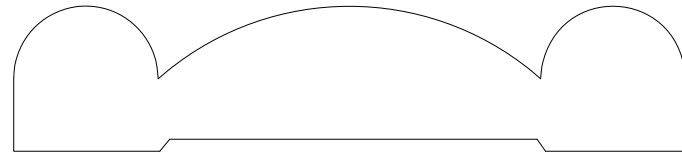

13175

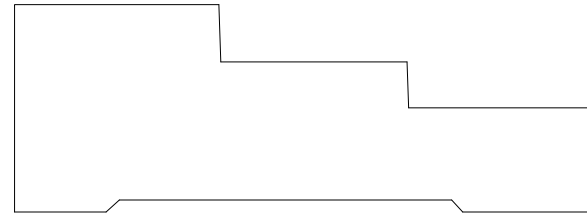

13176

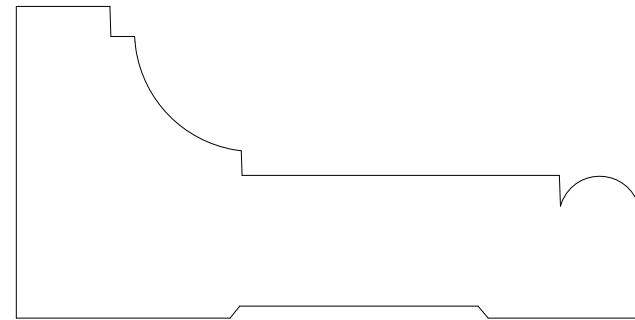

13177

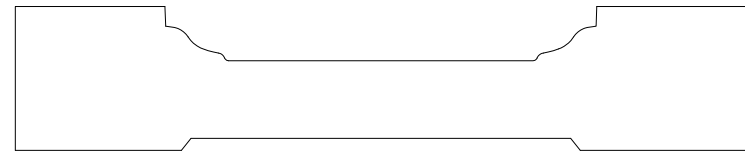

13178

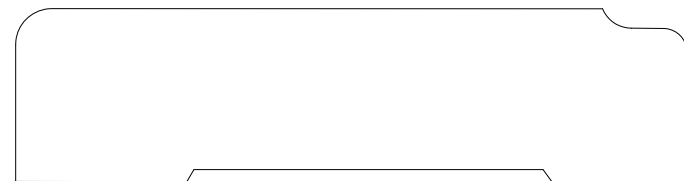

13179





13180



13185

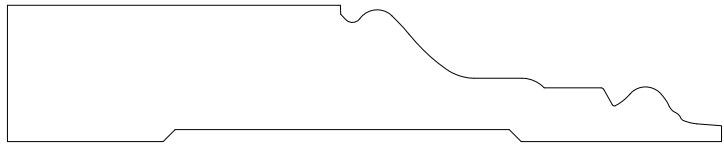

13181

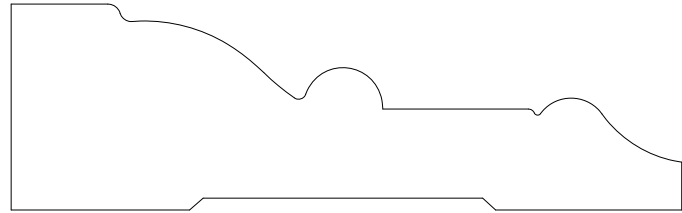

13186

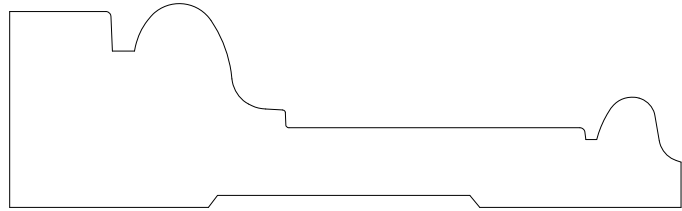

13182

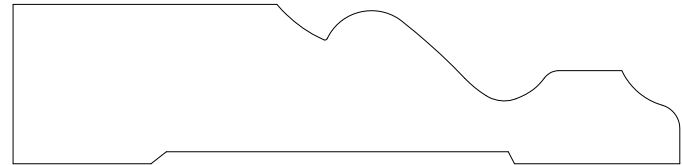

13187

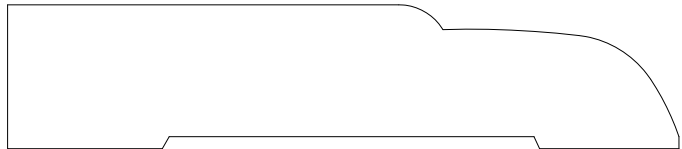

13183

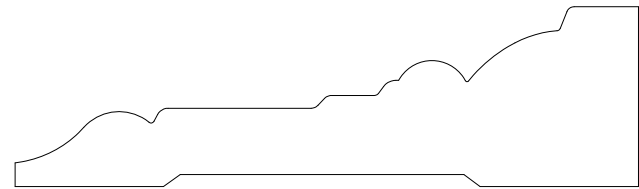

13188

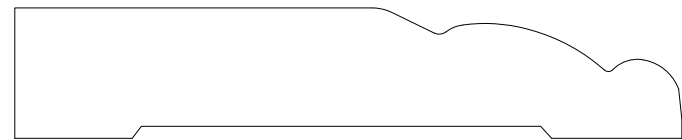

13184

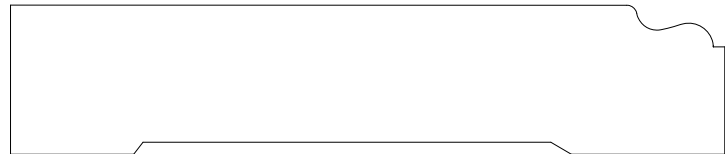

13189

|   |  |              |          |           |              |
|---|--|--------------|----------|-----------|--------------|
|  <p><b>S T A R K</b><br/>L U M B E R C O M P A N Y<br/>FINE WOOD MOULDING</p> | <p>924 W. 1st. Avenue<br/>Denver, CO 80223<br/>303-534-8263 Phone<br/>303-534-8266 Fax</p> | Approved by: | MM/DD/YY |           |              |
|   |  | Drawn:       |          |           |              |
|   |  | File name:   |          | Scale 1:1 | Sheet 1-3-18 |

|              |          |              |
|--------------|----------|--------------|
| Approved by: | MM/DD/YY |              |
| Drawn:       |          |              |
| File name:   |          | Scale 1:1    |
|              |          | Sheet 1-3-18 |

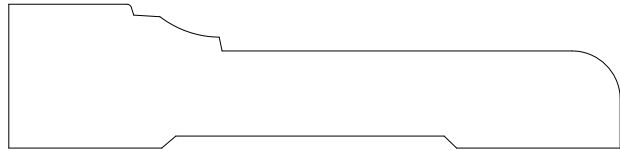

13190

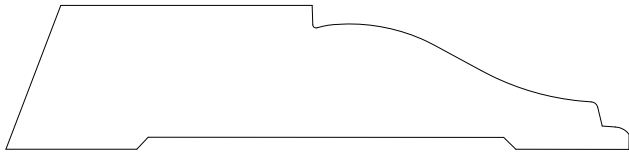

13191

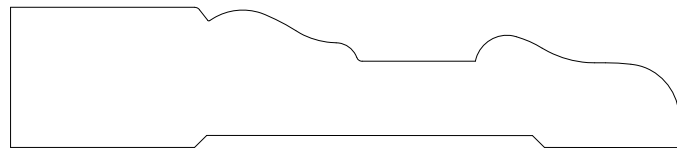

13192

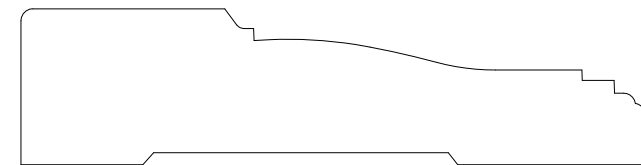

13193

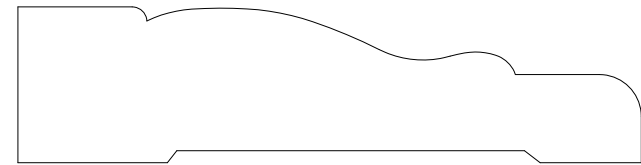

13194

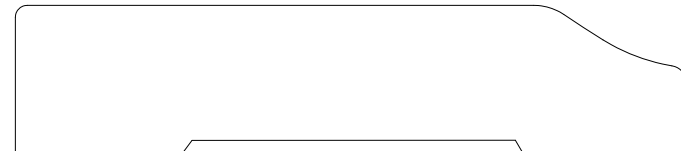

13195

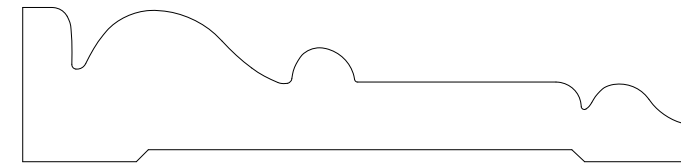

13196

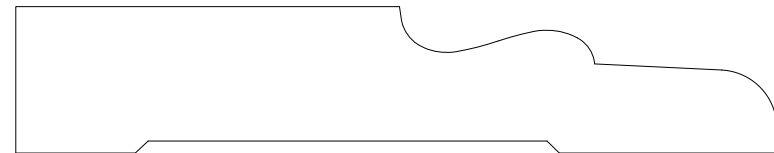

13197

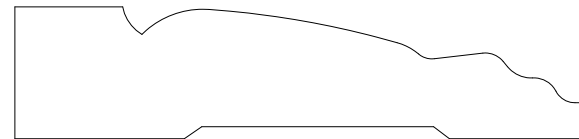

13198

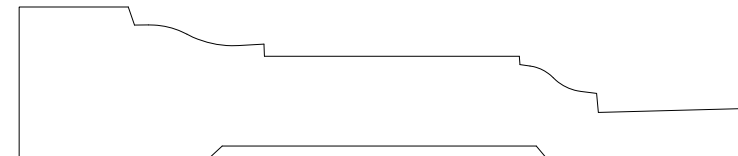

13199

|  |  |
|--|--|
|  | 924 W. 1st. Avenue<br>Denver, CO 80223<br>303-534-8263 Phone<br>303-534-8266 Fax |
|  |  |

|              |          |
|--------------|----------|
| Approved by: | MM/DD/YY |
| Drawn:       |          |
| File name:   |          |

|           |              |
|-----------|--------------|
| Scale 1:1 | Sheet 1-3-19 |
|-----------|--------------|

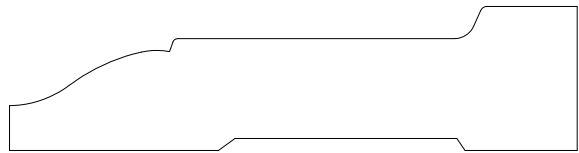

13200

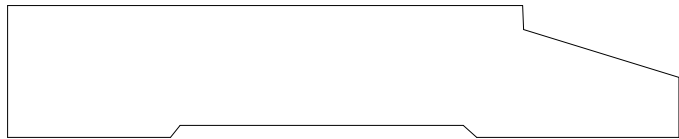

13201

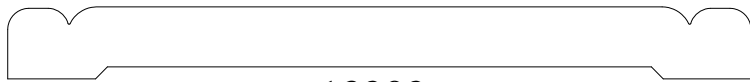

13202



13203

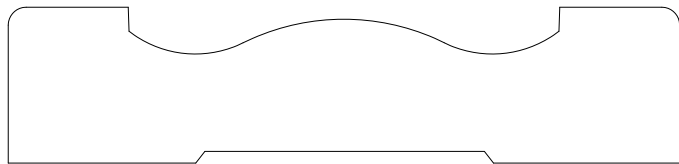

13204

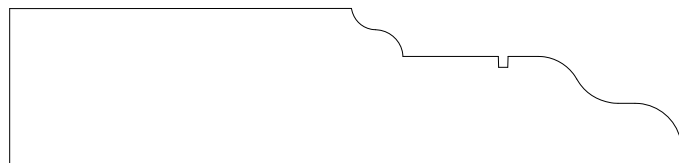

13205

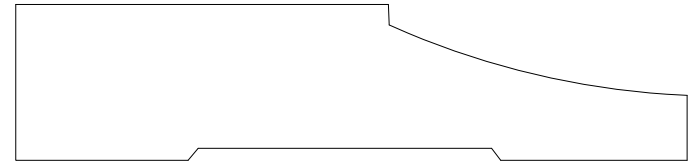

13206

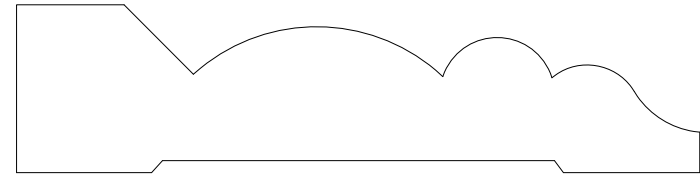

13207

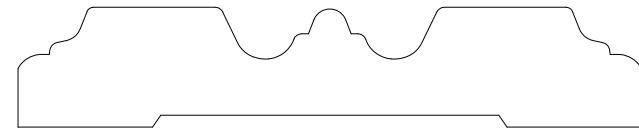

13208

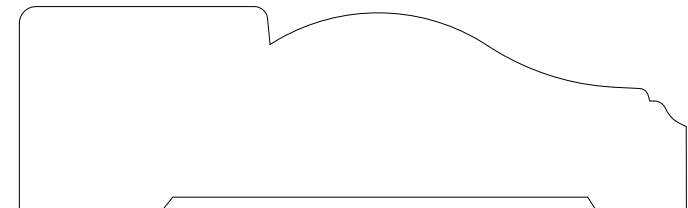

13209

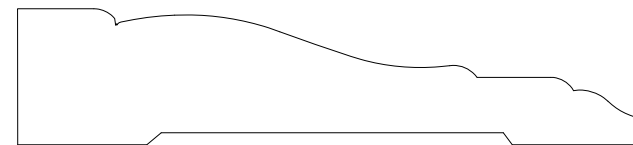

13210

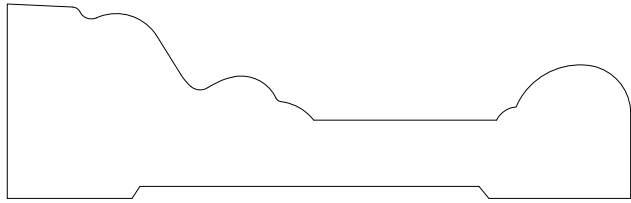

13211

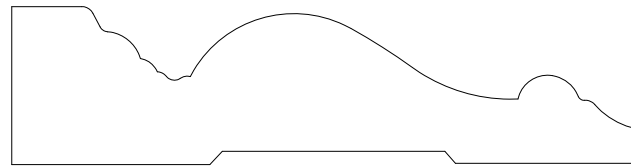

13212

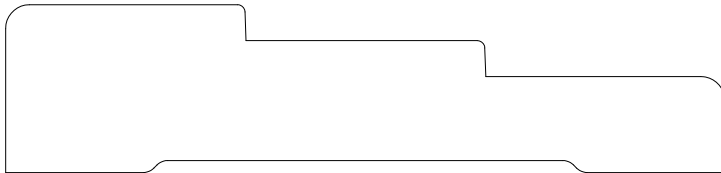

13213

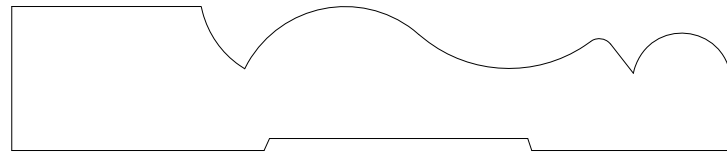

13214

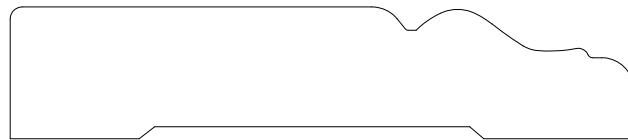

13215

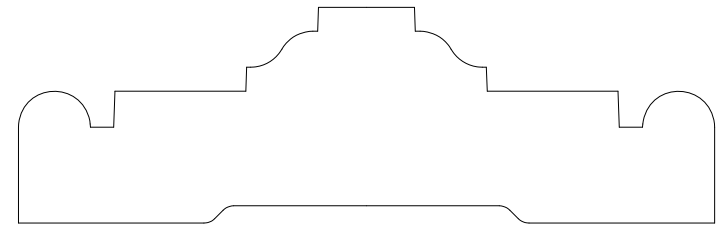

13216

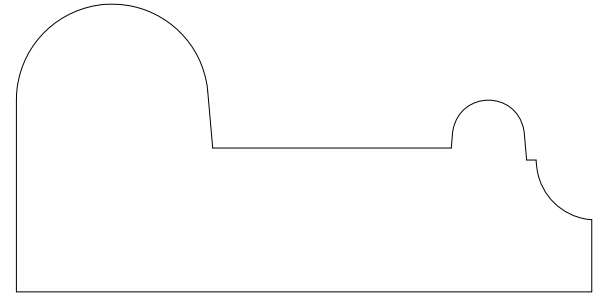

13217

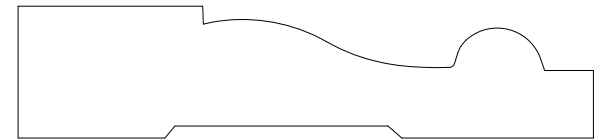

13218

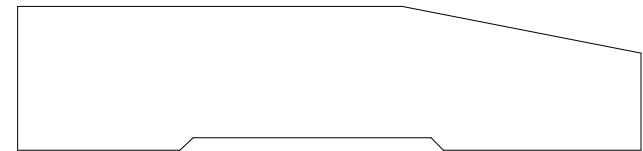

13219

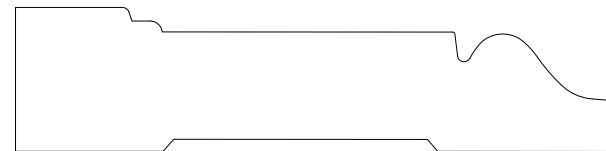

13220

EST. 1879

**S T A R K**

L U M B E R C O M P A N Y

FINE WOOD MOULDING

924 W. 1st. Avenue  
 Denver, CO 80223  
 303-534-8263 Phone  
 303-534-8266 Fax

|              |          |           |              |
|--------------|----------|-----------|--------------|
| Approved by: | MM/DD/YY |           |              |
| Drawn:       |          |           |              |
| File name:   |          | Scale 1:1 | Sheet 1-3-21 |

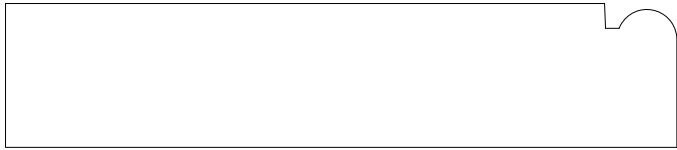

13221

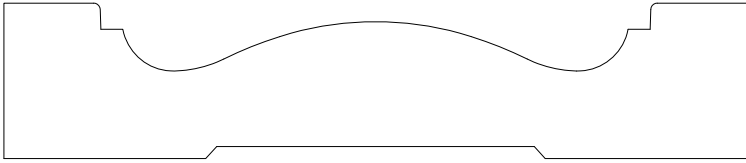

13222



13223

|   |   |
|---|---|
| <p>EST. 1879</p> <p><b>S T A R K</b></p> <p>L U M B E R C O M P A N Y</p> <p>FINE WOOD MOULDING</p> | <p>924 W. 1st. Avenue<br/>         Denver, CO 80223<br/>         303-534-8263 Phone<br/>         303-534-8266 Fax</p> |
|---|---|

|              |          |           |              |
|--------------|----------|-----------|--------------|
| Approved by: | MM/DD/YY |           |              |
| Drawn:       |          |           |              |
| File name:   |          | Scale 1:1 | Sheet 1-3-22 |



14001



14002

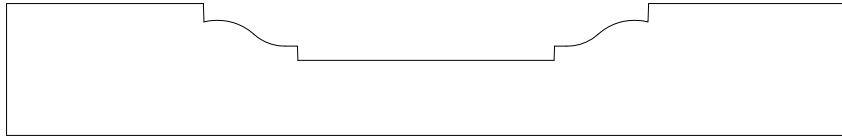

14003

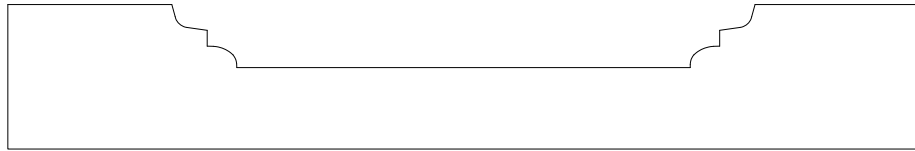

14004

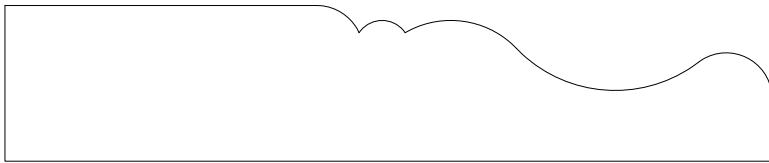

14005

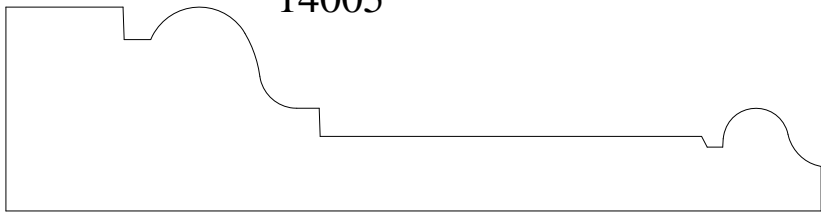

14006

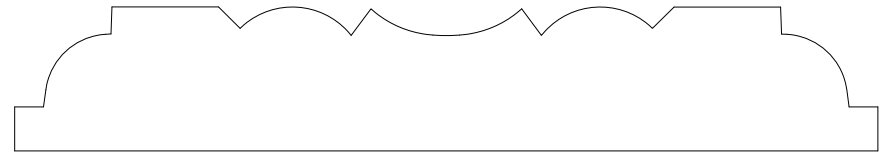

14007

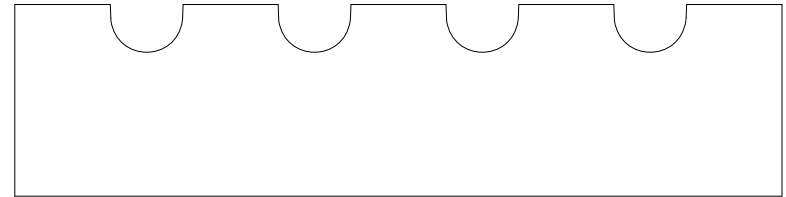

14008

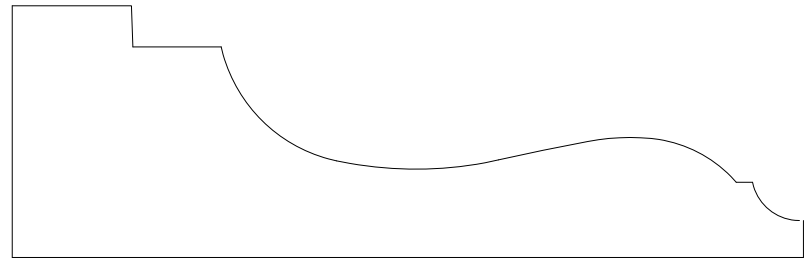

14009

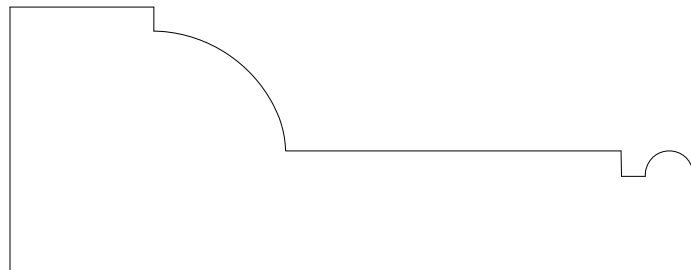

14010

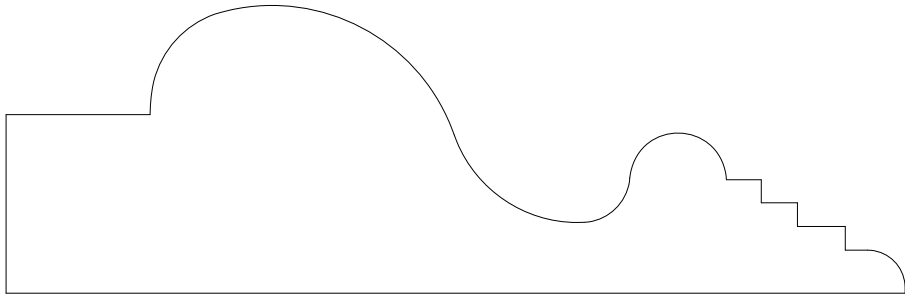

14011

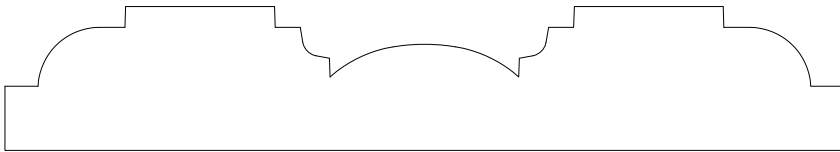

14012

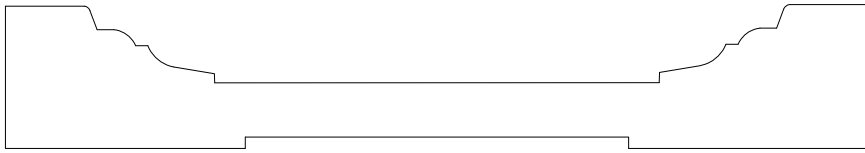

14013

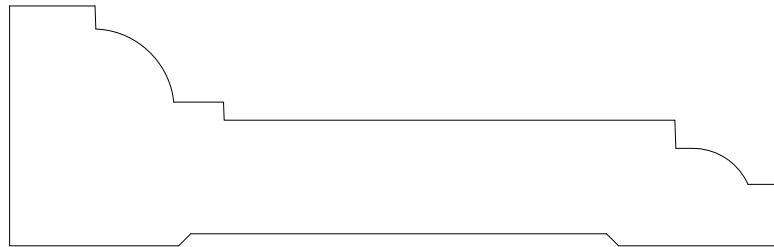

14014

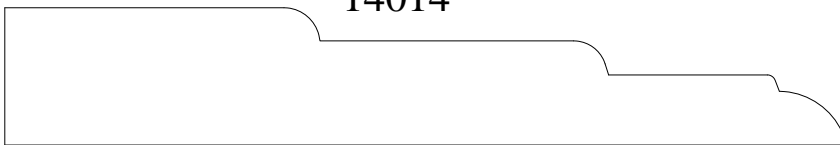

14015

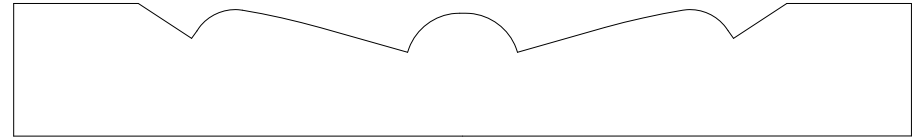

14016

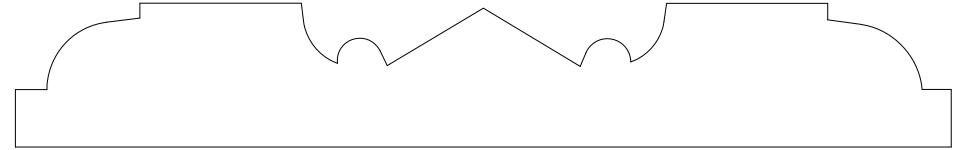

14017



14018



14019

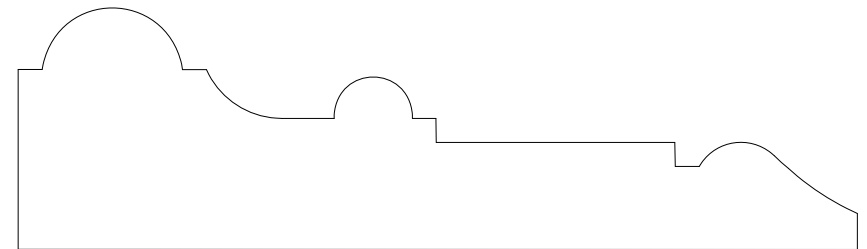

14020

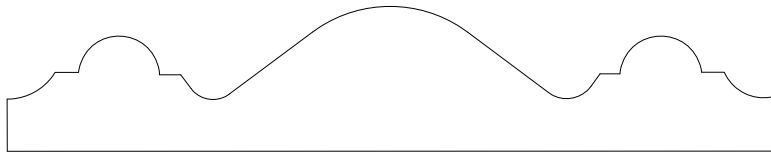

14021

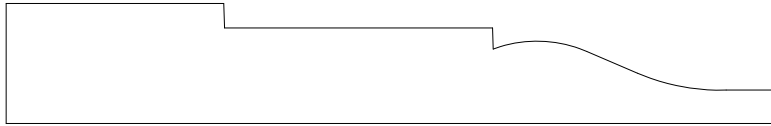

14022



14023



14024

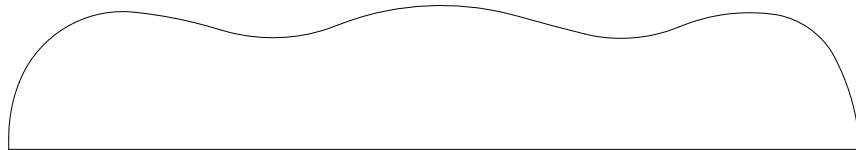

14025

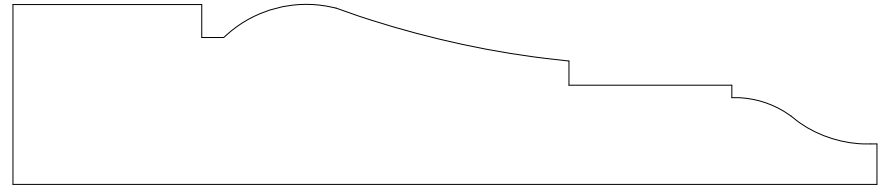

14026

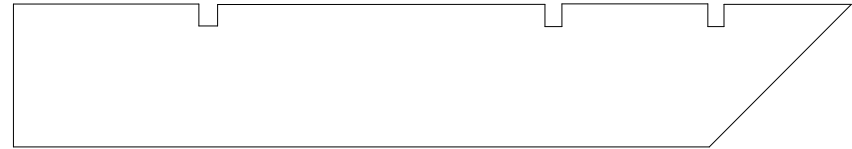

14027



14028

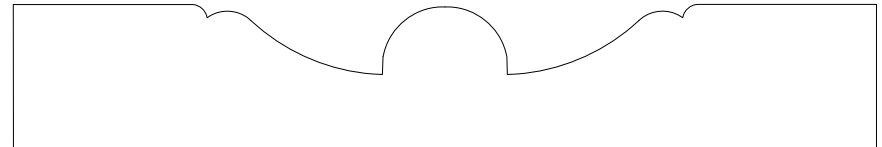

14029



14030





14031

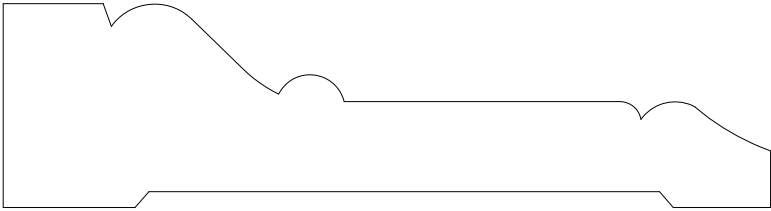

14032

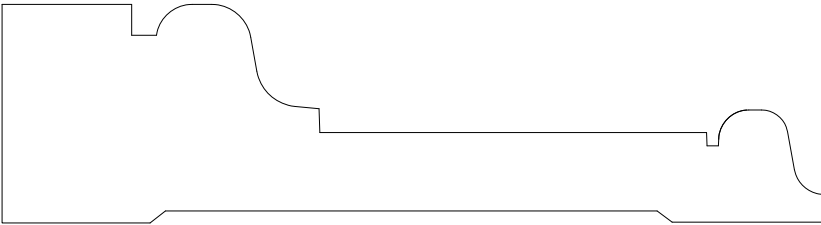

14033

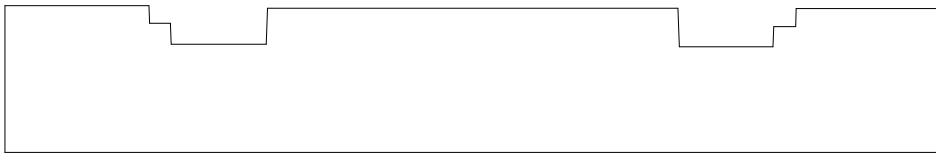

14034

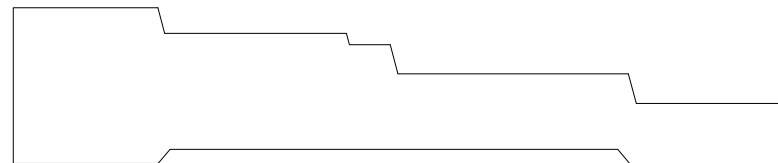

14035

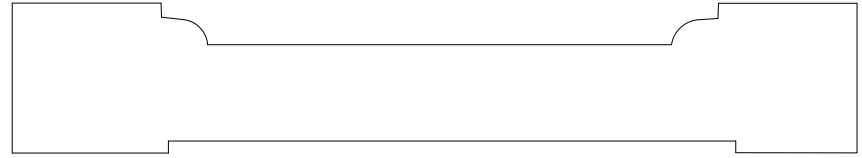

14036

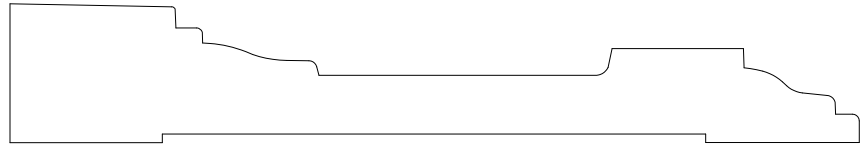

14037



14038

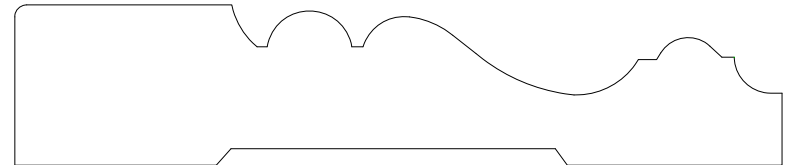

14039

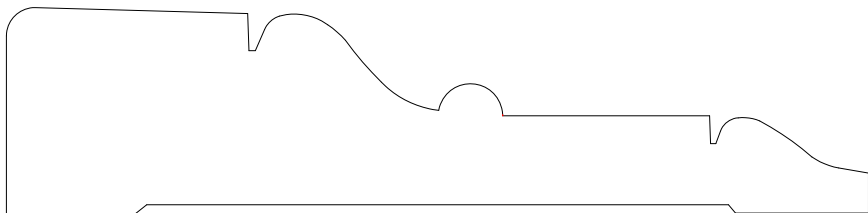

14040



924 W. 1st. Avenue  
Denver, CO 80223  
303-534-8263 Phone  
303-534-8266 Fax

|              |          |             |
|--------------|----------|-------------|
| Approved by: | MM/DD/YY |             |
| Drawn:       |          |             |
| File name:   |          | Scale 1:1   |
|              |          | Sheet 1-4-4 |

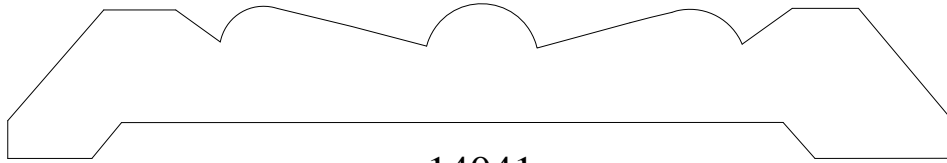

14041



14046

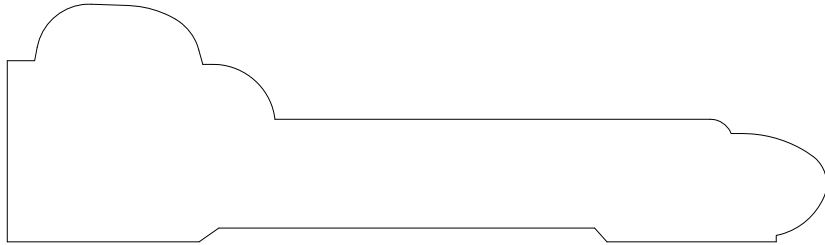

14042

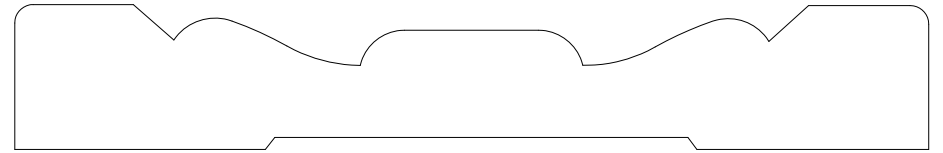

14047

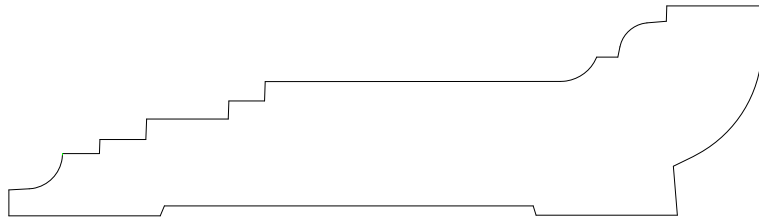

14043

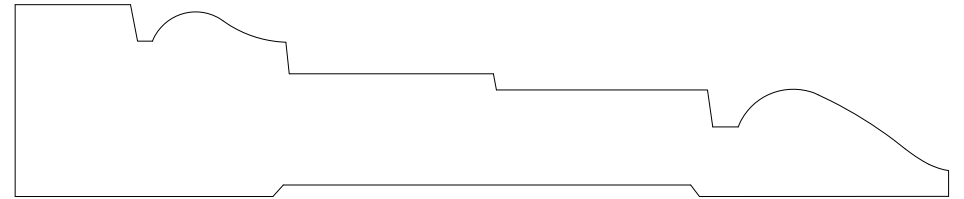

14048

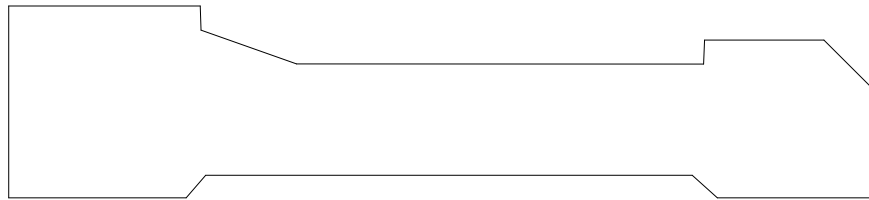

14044

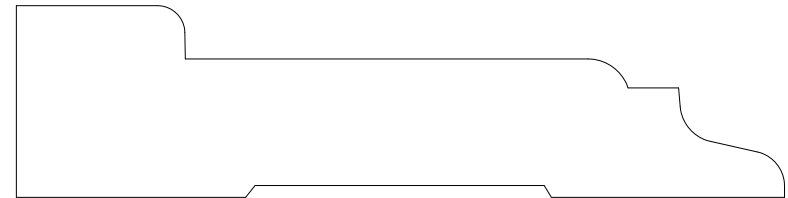

14049

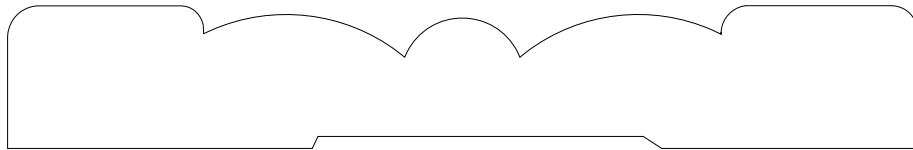

14045

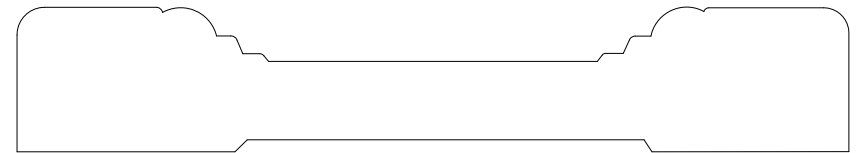

14050

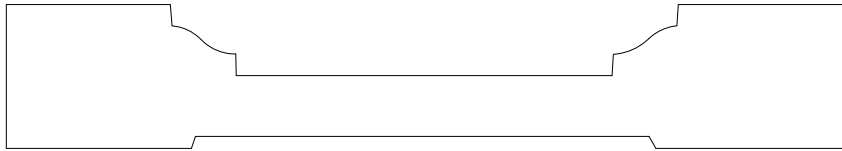

14051

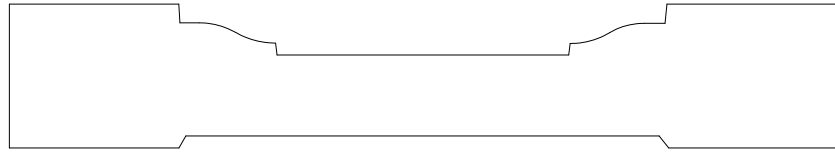

14052



14053

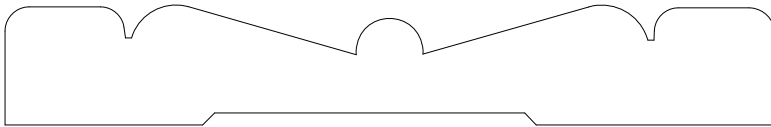

14054

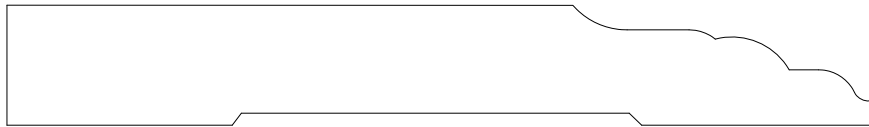

14055

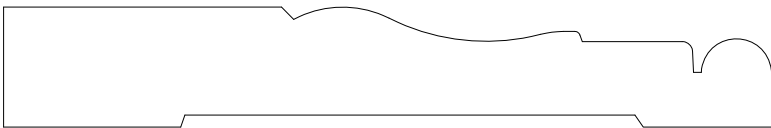

14056

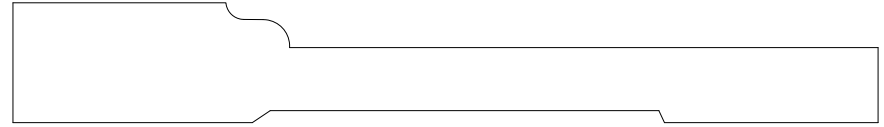

14057



14058

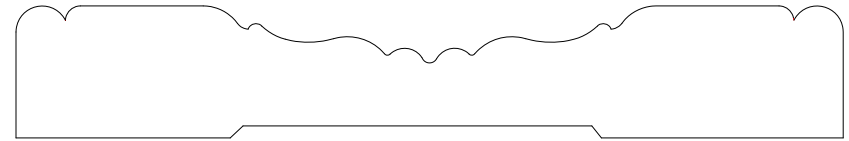

14059

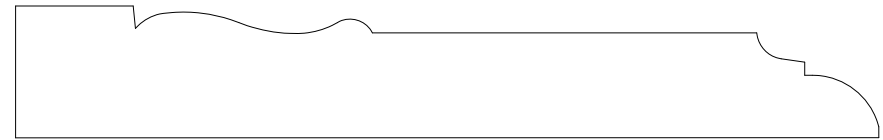

14060

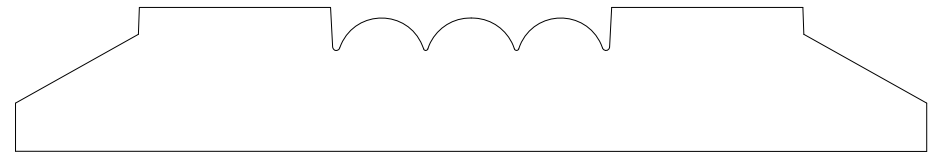

14061

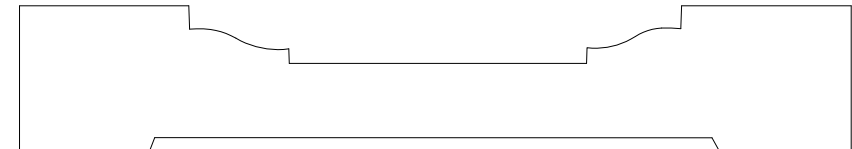

14062

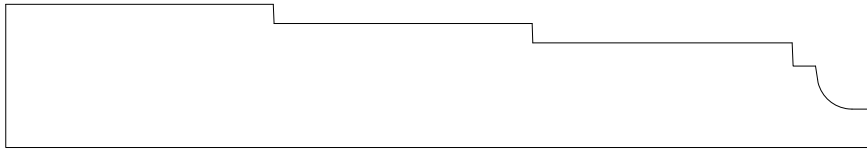

14063

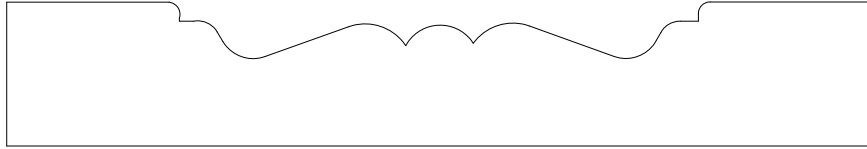

14064

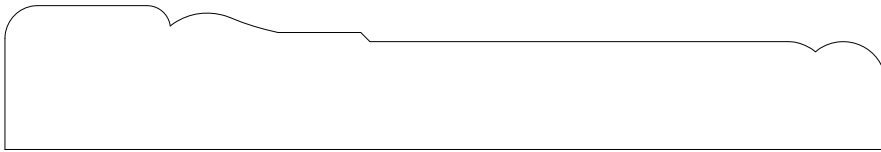

14065

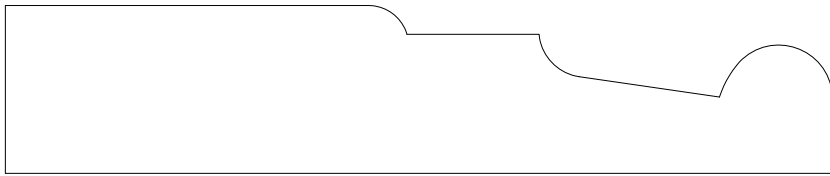

14066

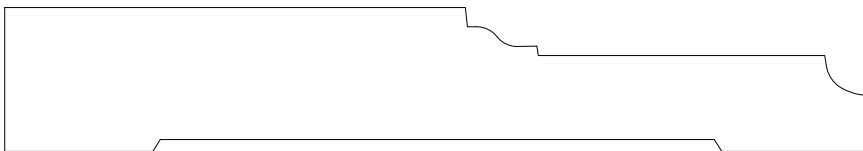

14067

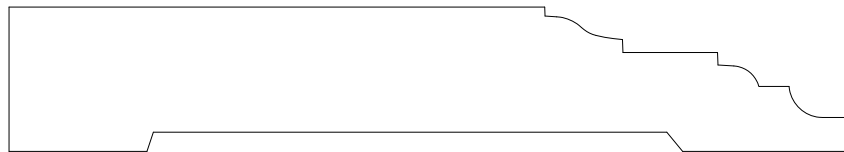

14068

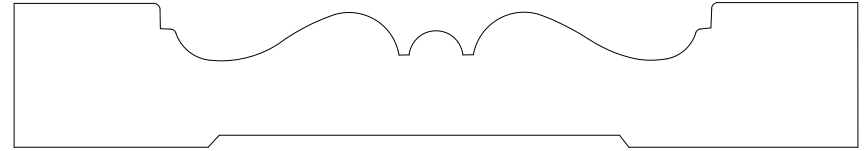

14069



14070

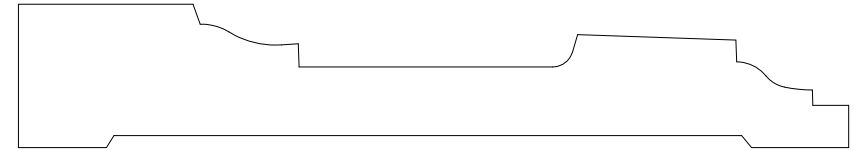

14071

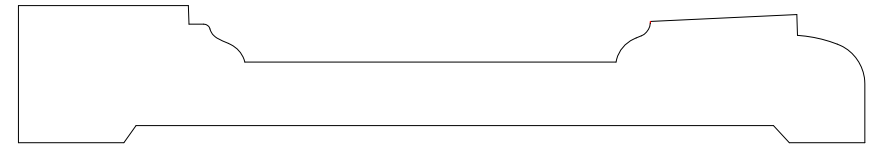

14072

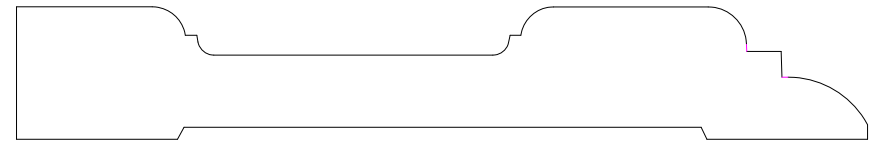

14073

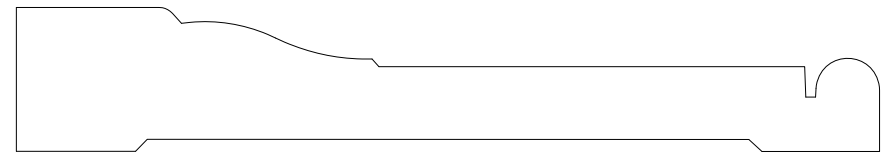

14074

EST. 1879

**S T A R K**

L U M B E R C O M P A N Y

FINE WOOD MOULDING

924 W. 1st. Avenue  
 Denver, CO 80223  
 303-534-8263 Phone  
 303-534-8266 Fax

|              |          |           |             |
|--------------|----------|-----------|-------------|
| Approved by: | MM/DD/YY |           |             |
| Drawn:       |          |           |             |
| File name:   |          | Scale 1:1 | Sheet 1-4-7 |

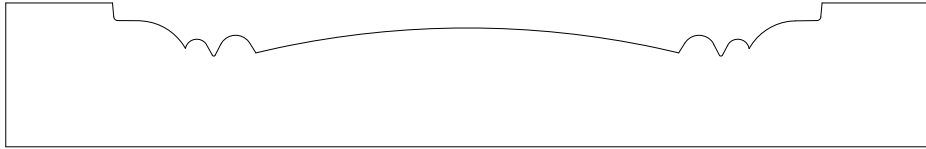

14075

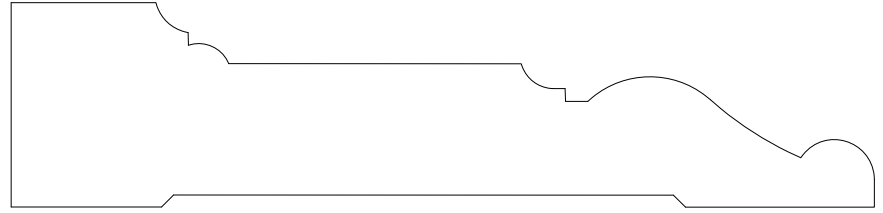

14080



14076

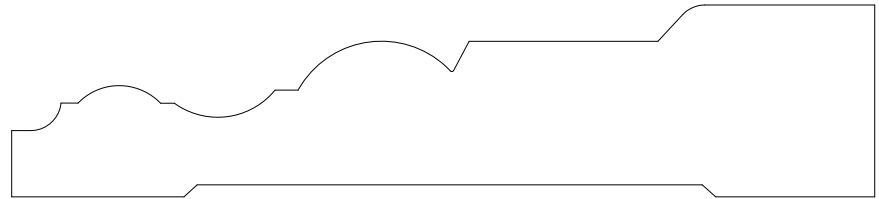

14081



14077

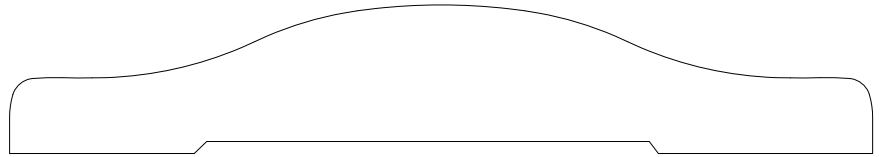

14082

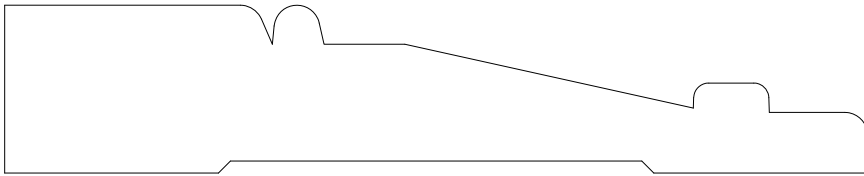

14078



14083

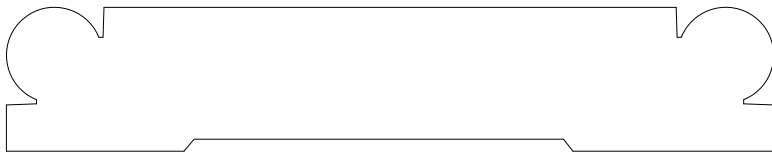

14079

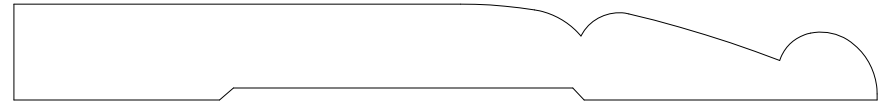

14084

EST. 1879

**S T A R K**

L U M B E R C O M P A N Y

FINE WOOD MOULDING

924 W. 1st. Avenue  
 Denver, CO 80223  
 303-534-8263 Phone  
 303-534-8266 Fax

|              |          |                       |
|--------------|----------|-----------------------|
| Approved by: | MM/DD/YY |                       |
| Drawn:       |          |                       |
| File name:   |          | Scale 1:1 Sheet 1-4-8 |

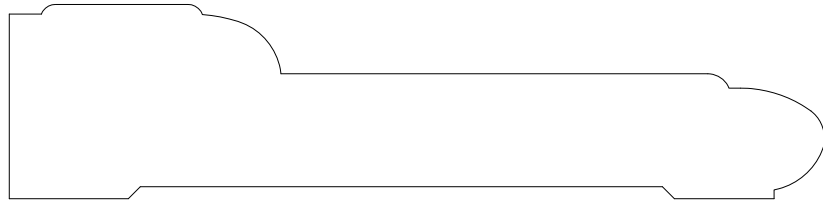

14085

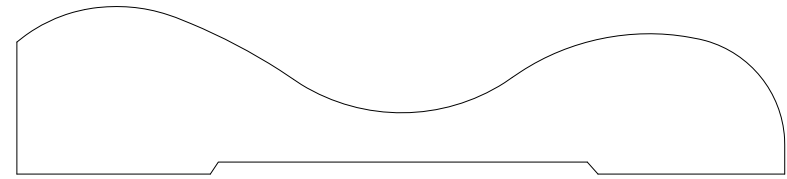

14091

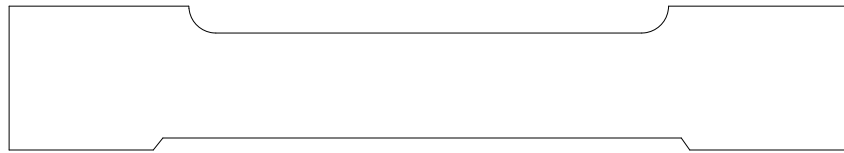

14086

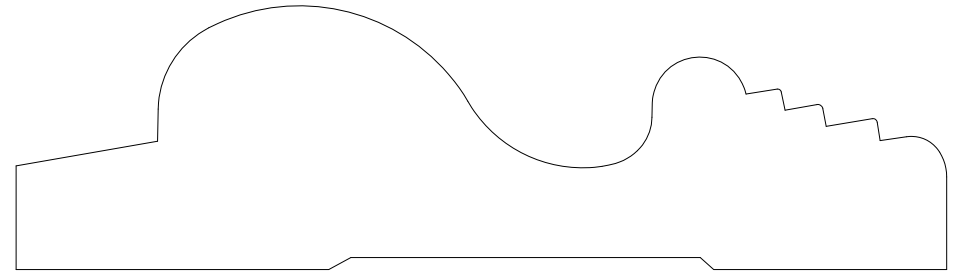

14092

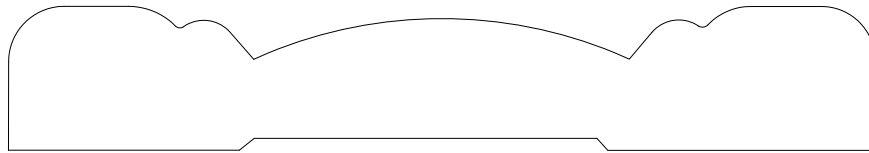

14087

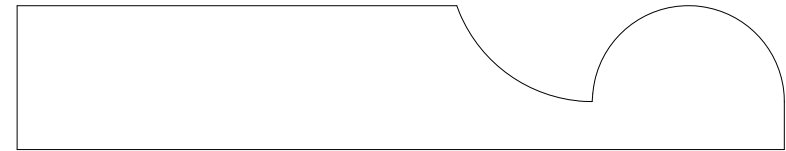

14093

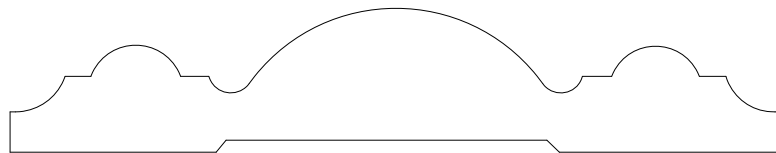

14088

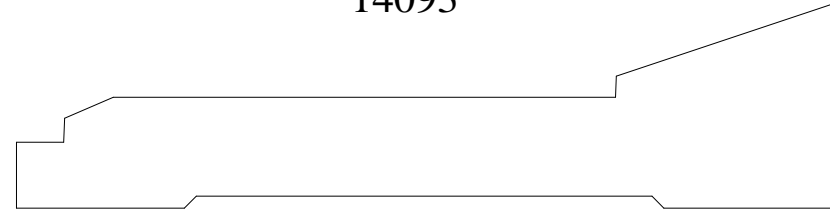

14094

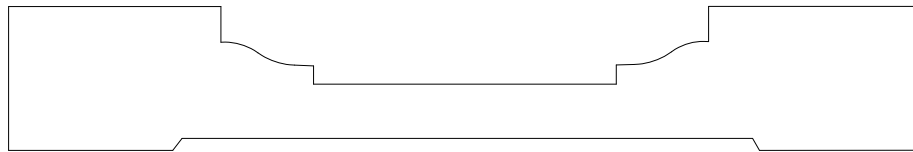

14089

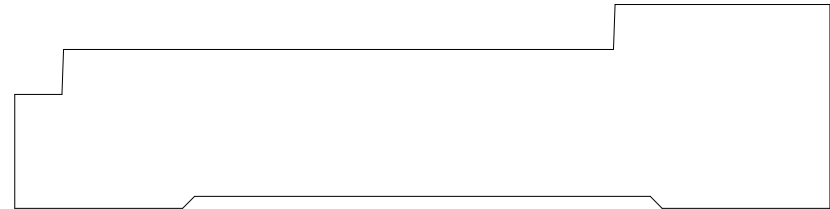

14095

EST. 1879

**S T A R K**  
L U M B E R C O M P A N Y  
FINE WOOD MOULDING

924 W. 1st. Avenue  
Denver, CO 80223  
303-534-8263 Phone  
303-534-8266 Fax

Approved by:

MM/DD/YY

Drawn:

File name:

Scale 1:1

Sheet 1-4-9

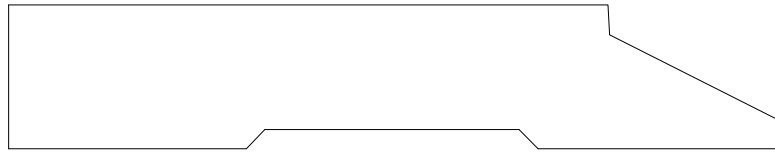

14096

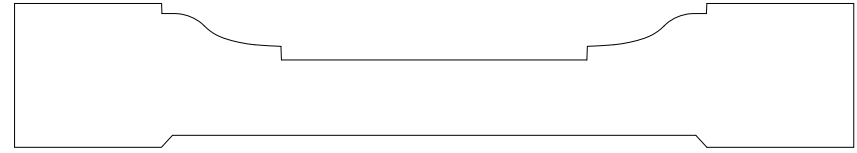

14101

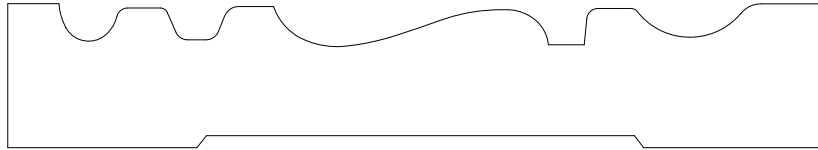

14097

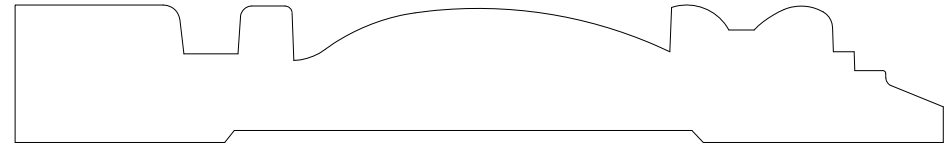

14102

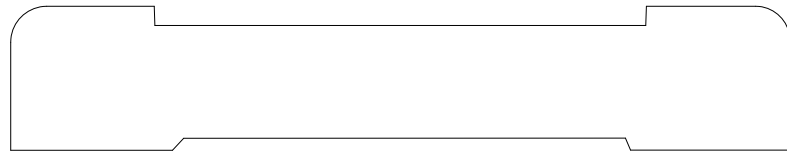

14098

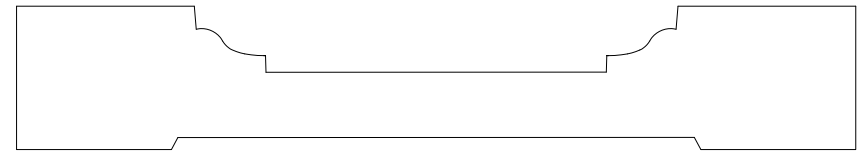

14103

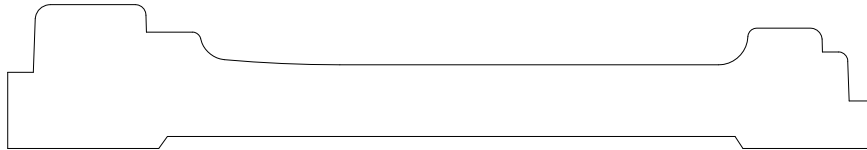

14099

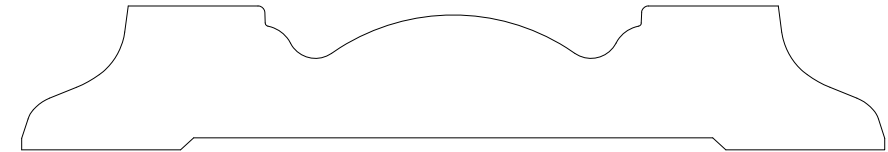

14104

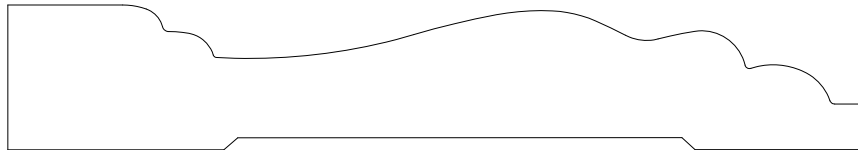

14100

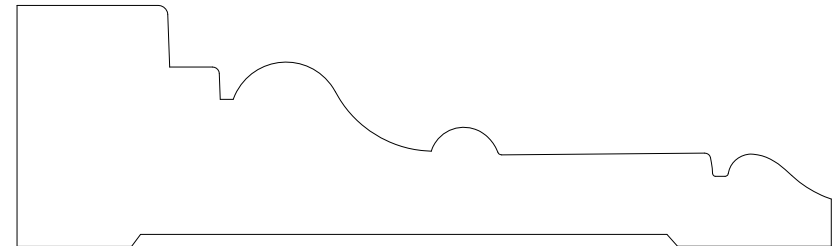

14105

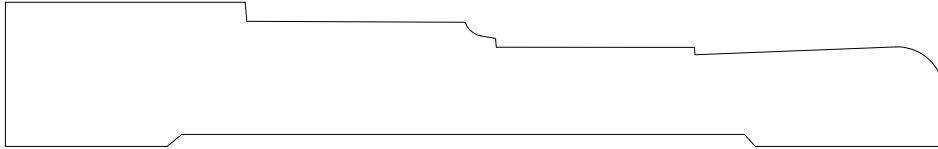

14106

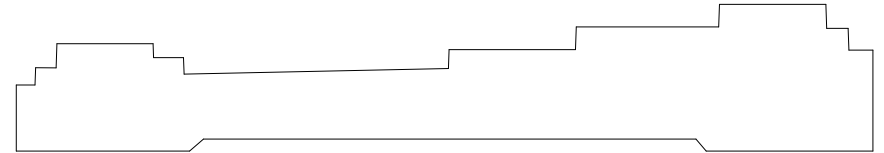

14112



14107

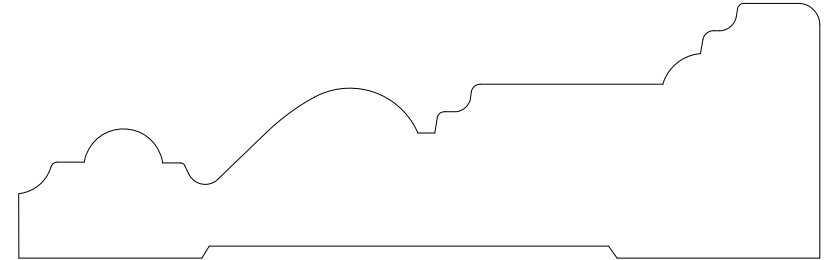

14113

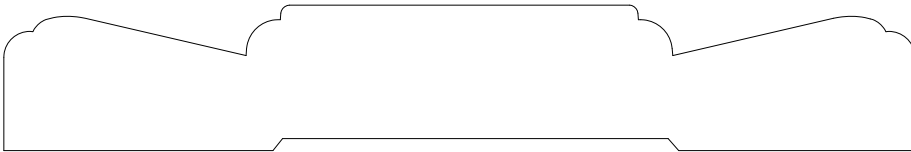

14108

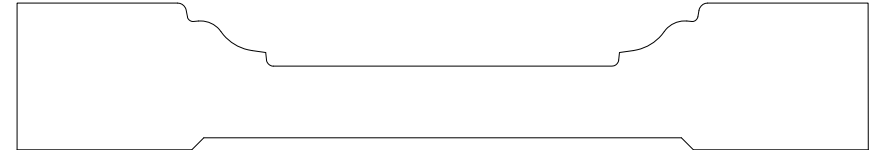

14114

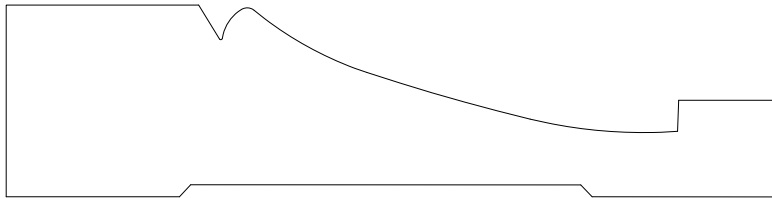

14109

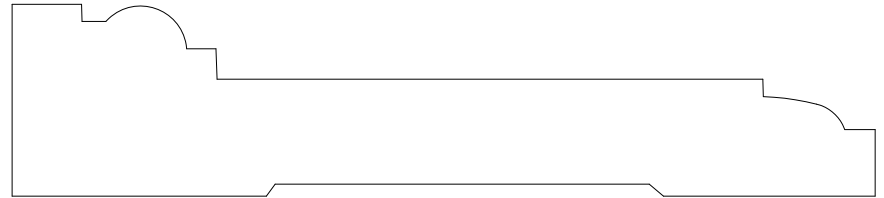

14115

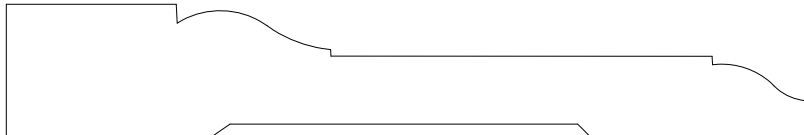

14110

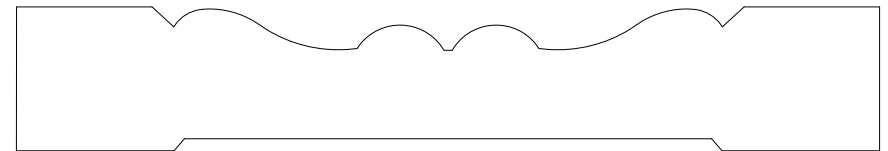

14116

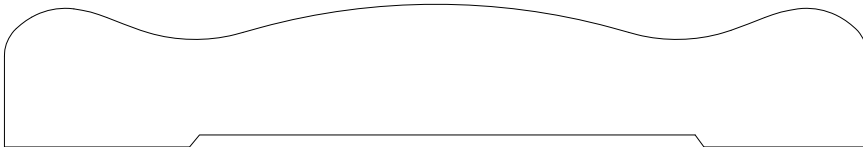

14111

EST. 1879

**S T A R K**

L U M B E R C O M P A N Y

FINE WOOD MOULDING

924 W. 1st. Avenue  
 Denver, CO 80223  
 303-534-8263 Phone  
 303-534-8266 Fax

|              |          |                        |
|--------------|----------|------------------------|
| Approved by: | MM/DD/YY |                        |
| Drawn:       |          |                        |
| File name:   |          | Scale 1:1 Sheet 1-4-11 |



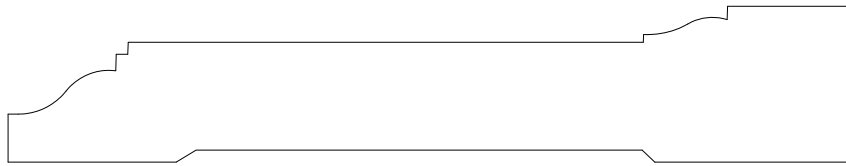

14117

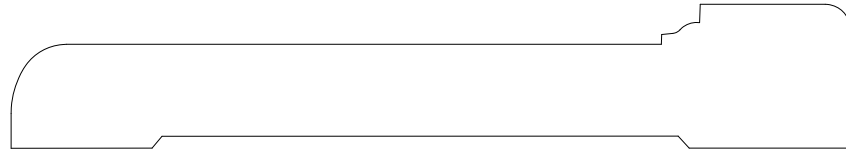

14118

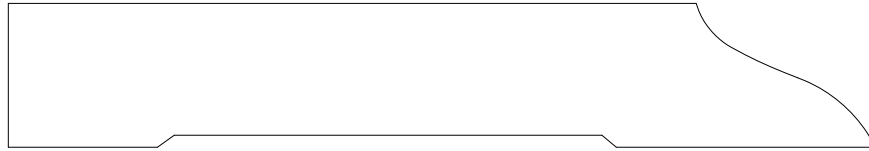

14119

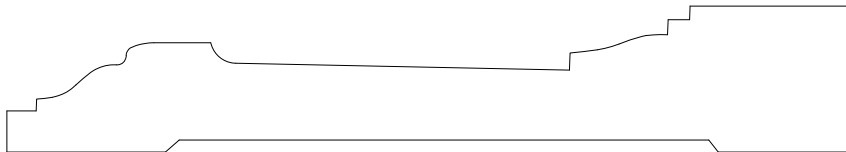

14120

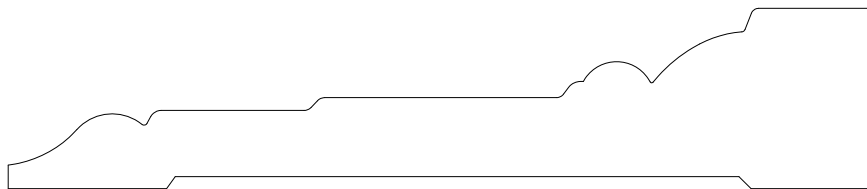

14121

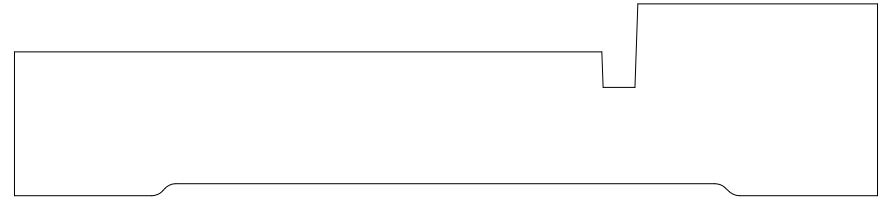

14122

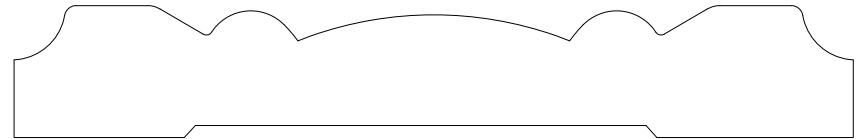

14123

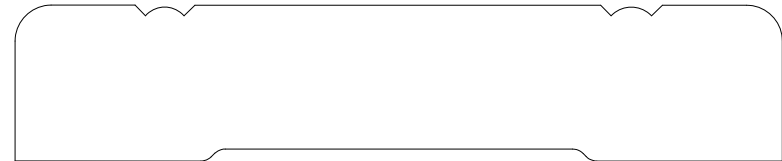

14124

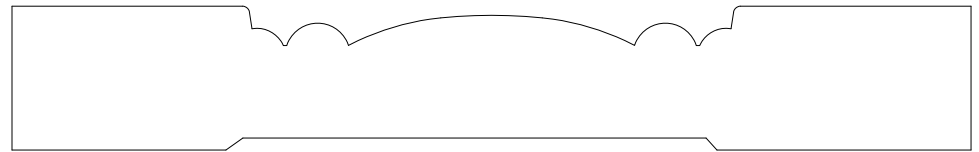

14125

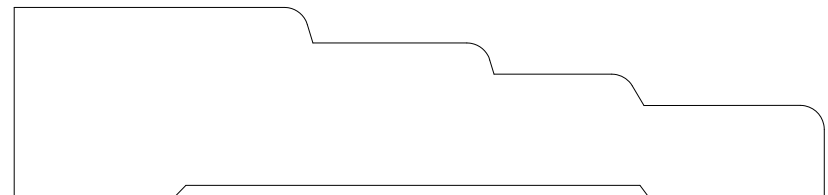

14126



14127



14128

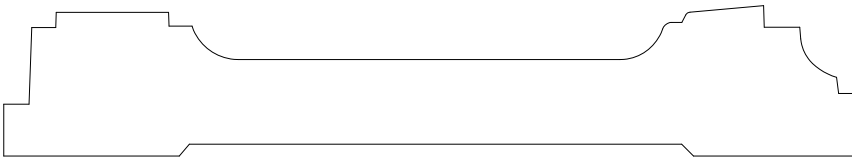

14129

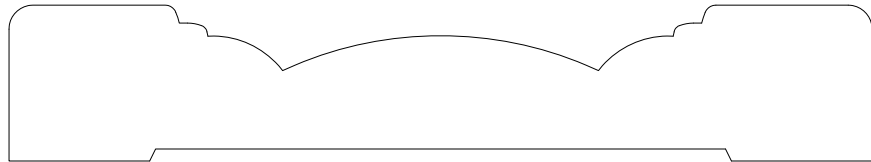

14130

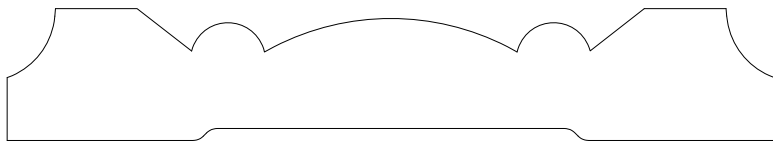

14131

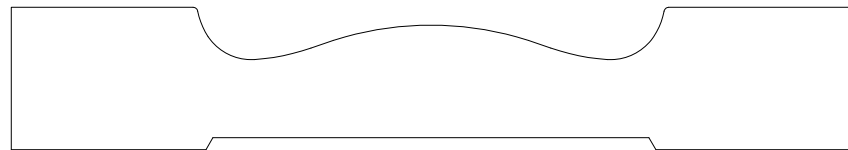

14132

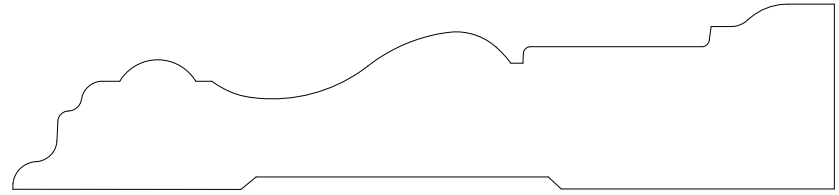

14133

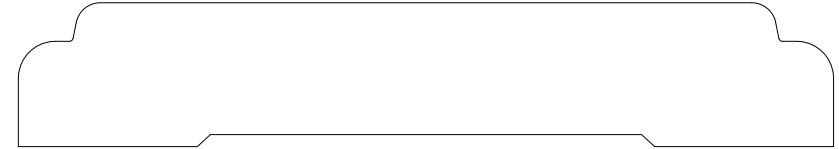

14134

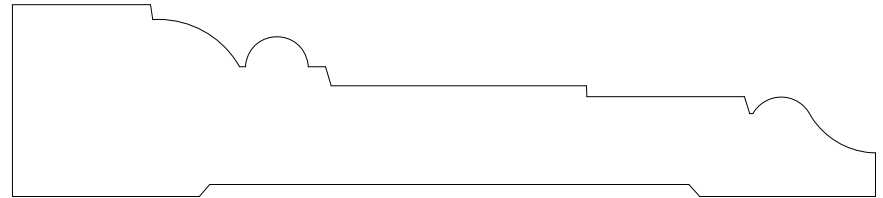

14135

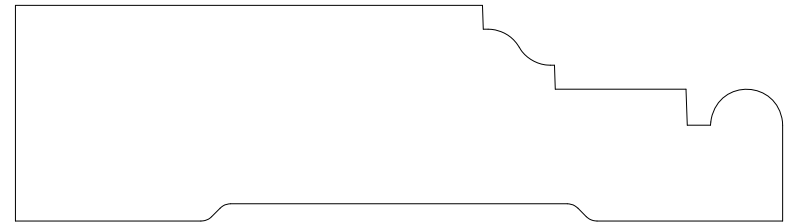

14136

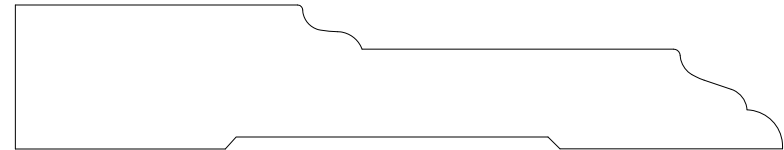

14137

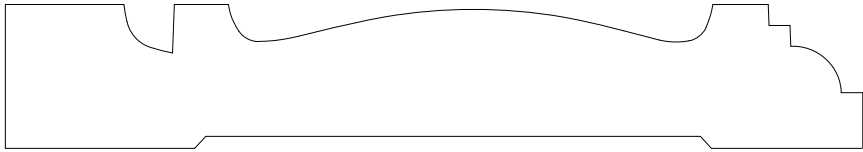

14138

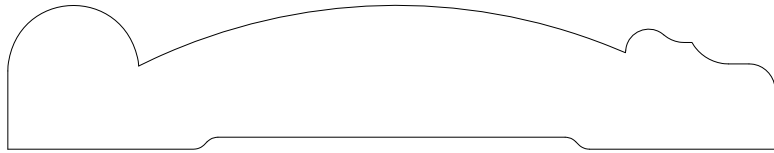

14139

EST. 1879  
**S T A R K**  
L U M B E R C O M P A N Y  
FINE WOOD MOULDING

924 W. 1st. Avenue  
Denver, CO 80223  
303-534-8263 Phone  
303-534-8266 Fax

|              |          |           |              |
|--------------|----------|-----------|--------------|
| Approved by: | MM/DD/YY |           |              |
| Drawn:       |          |           |              |
| File name:   |          | Scale 1:1 | Sheet 1-4-14 |

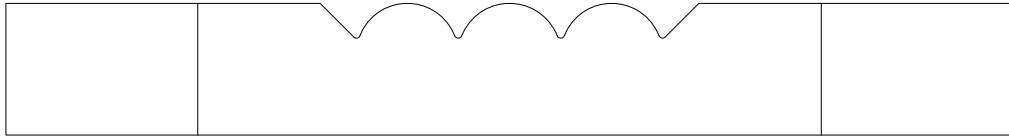

15001

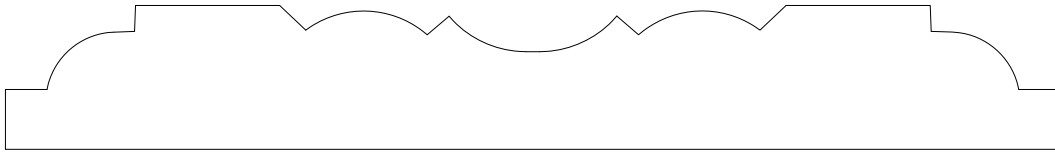

15002

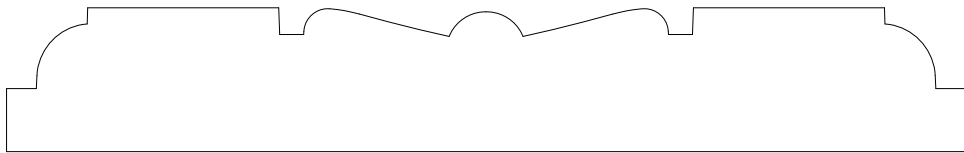

15003

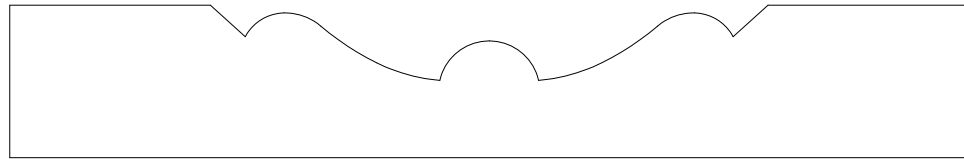

15004



15005

|   |  |
|---|--|
| <p style="text-align: center;">EST. 1879</p> <p style="text-align: center;"><b>S T A R K</b></p> <p style="text-align: center;">L U M B E R C O M P A N Y</p> <p style="text-align: center;">FINE WOOD MOULDING</p> | <p>924 W. 1st. Avenue<br/>Denver, CO 80223<br/>303-534-8263 Phone<br/>303-534-8266 Fax</p> |
|---|--|

|              |          |           |             |
|--------------|----------|-----------|-------------|
| Approved by: | MM/DD/YY |           |             |
| Drawn:       |          |           |             |
| File name:   |          | Scale 1:1 | Sheet 1-5-1 |

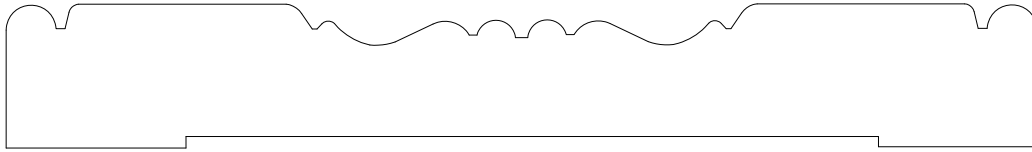

15006

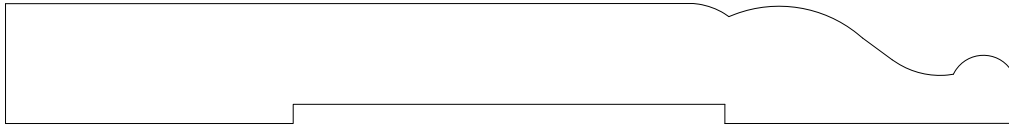

15007

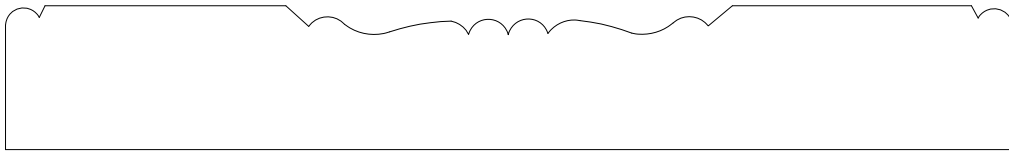

15008

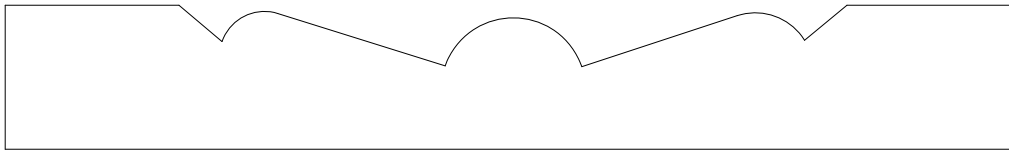

15009

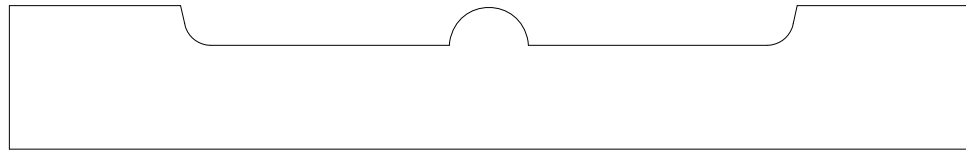

15010

EST. 1879

**S T A R K**

L U M B E R C O M P A N Y

FINE WOOD MOULDING

924 W. 1st. Avenue  
 Denver, CO 80223  
 303-534-8263 Phone  
 303-534-8266 Fax

|              |          |             |
|--------------|----------|-------------|
| Approved by: | MM/DD/YY |             |
| Drawn:       |          |             |
| File name:   |          | Scale 1:1   |
|              |          | Sheet 1-5-2 |

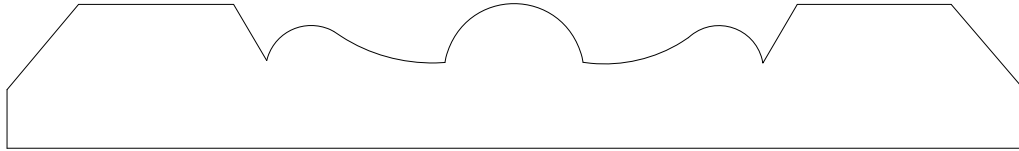

15011

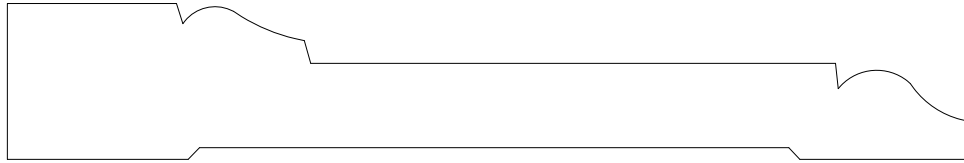

15012

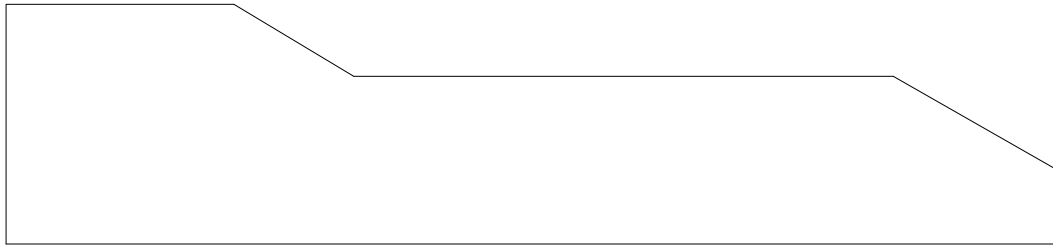

15013

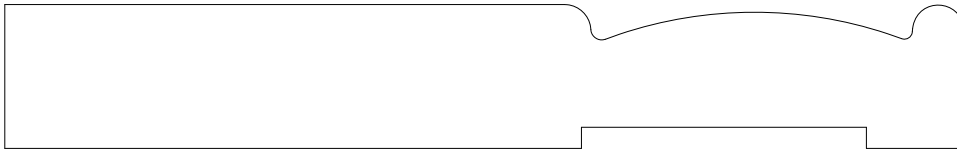

15014

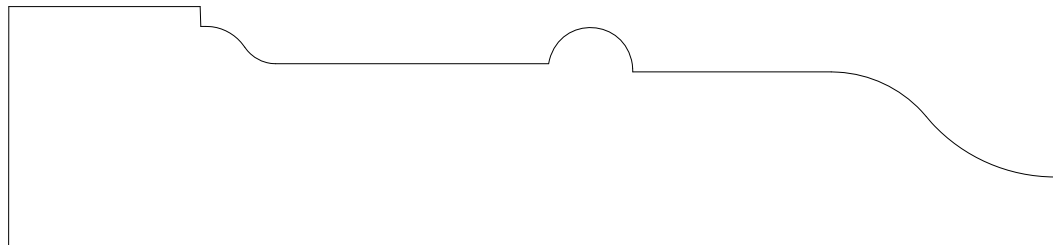

15015



924 W. 1st. Avenue  
Denver, CO 80223  
303-534-8263 Phone  
303-534-8266 Fax

|              |          |             |
|--------------|----------|-------------|
| Approved by: | MM/DD/YY |             |
| Drawn:       |          |             |
| File name:   |          | Scale 1:1   |
|              |          | Sheet 1-5-3 |

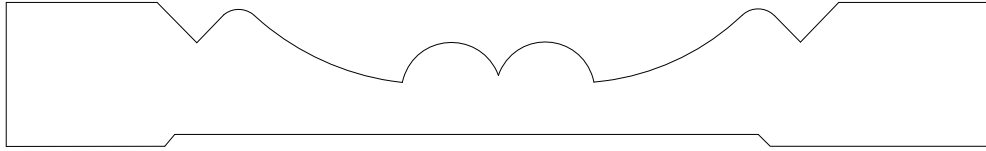

15016

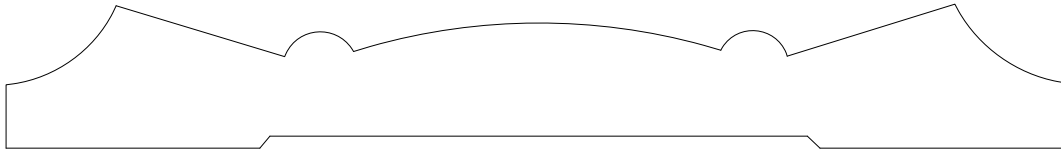

15017

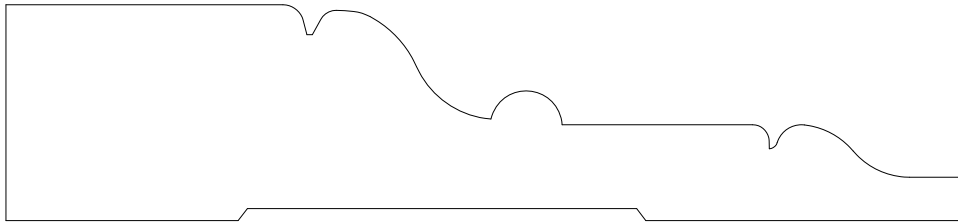

15018

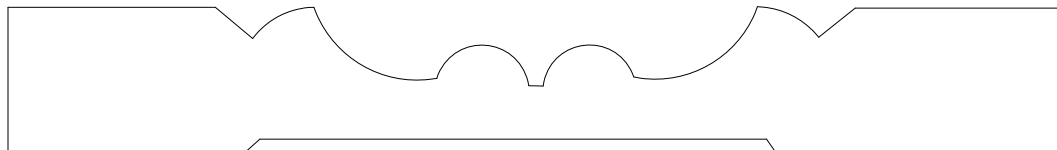

15019

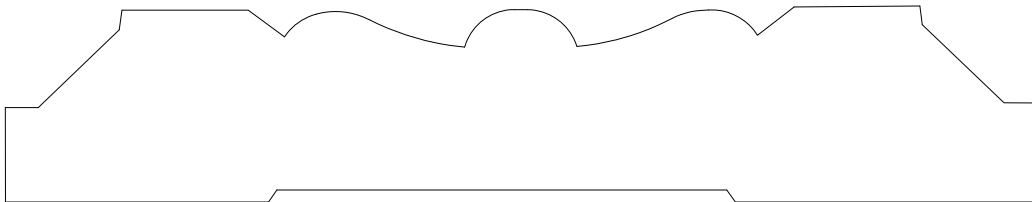

15020

EST. 1879

**S T A R K**

L U M B E R C O M P A N Y

FINE WOOD MOULDING

924 W. 1st. Avenue  
 Denver, CO 80223  
 303-534-8263 Phone  
 303-534-8266 Fax

|              |          |           |             |
|--------------|----------|-----------|-------------|
| Approved by: | MM/DD/YY |           |             |
| Drawn:       |          |           |             |
| File name:   |          | Scale 1:1 | Sheet 1-5-4 |

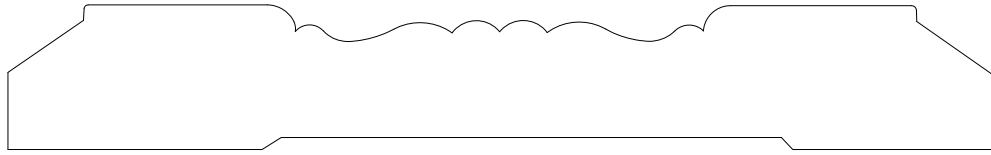

15021

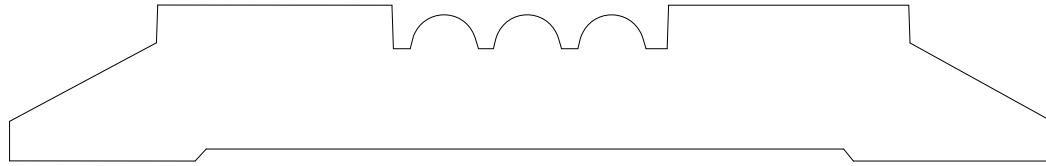

15022

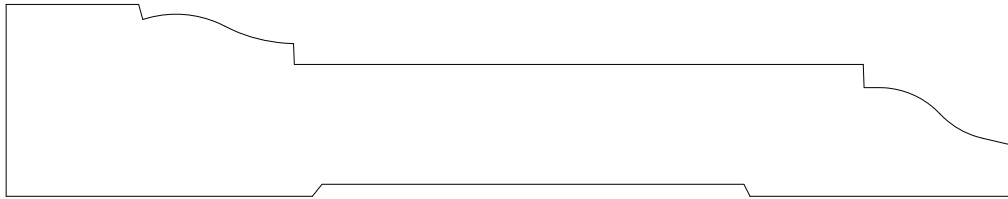

15023

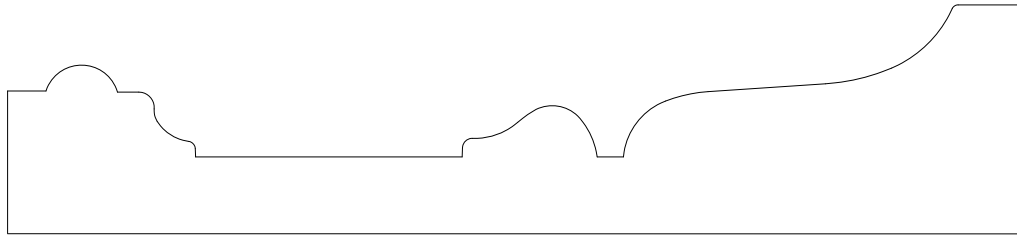

15024

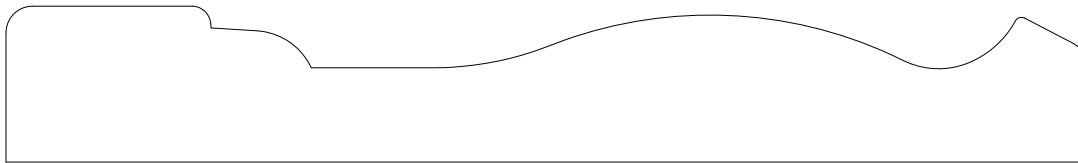

15025



924 W. 1st. Avenue  
Denver, CO 80223  
303-534-8263 Phone  
303-534-8266 Fax

|              |          |           |             |
|--------------|----------|-----------|-------------|
| Approved by: | MM/DD/YY |           |             |
| Drawn:       |          |           |             |
| File name:   |          | Scale 1:1 | Sheet 1-5-5 |



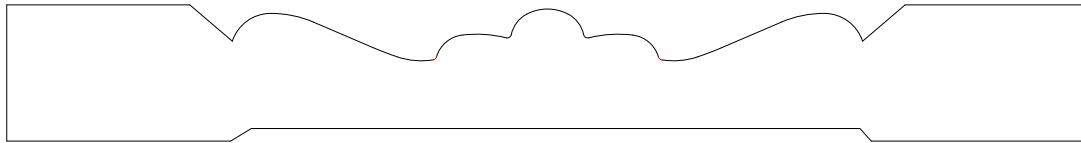

15026

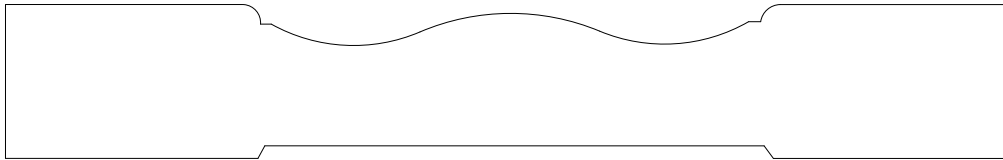

15027

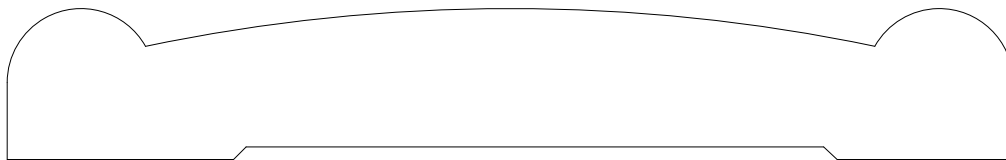

15028

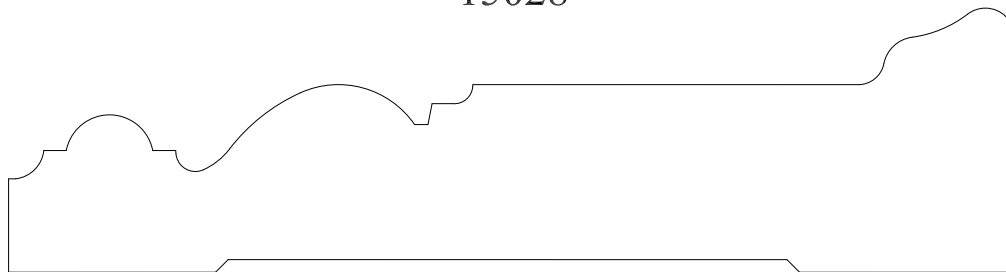

15029

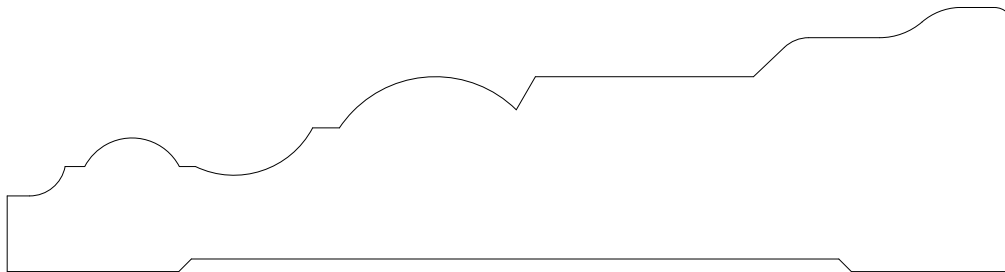

15030



924 W. 1st. Avenue  
Denver, CO 80223  
303-534-8263  
Phone  
303-534-8266 Fax

|              |          |           |             |
|--------------|----------|-----------|-------------|
| Approved by: | MM/DD/YY |           |             |
| Drawn:       |          |           |             |
| File name:   |          | Scale 1:1 | Sheet 1-5-6 |

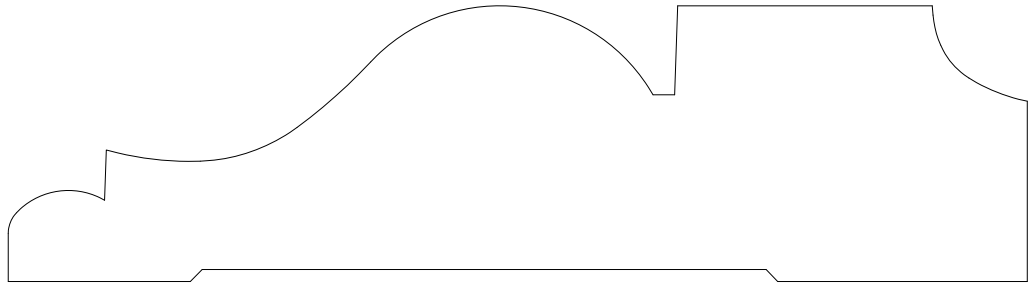

15031

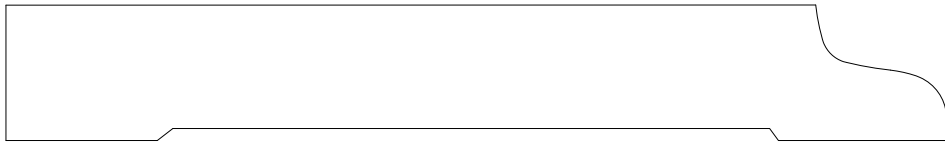

15032

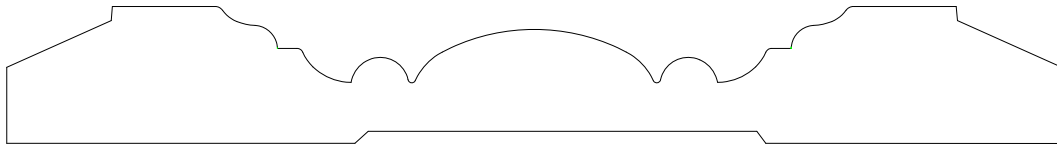

15033

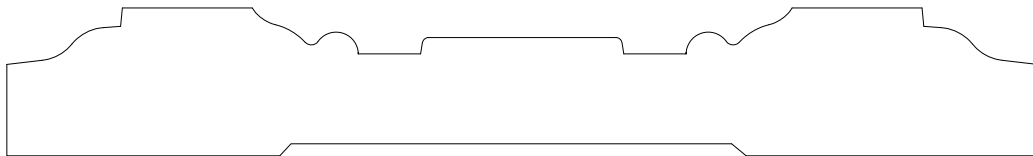

15034

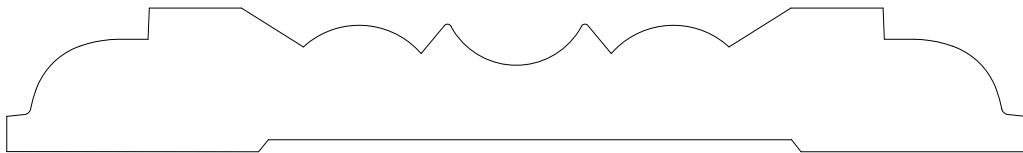

15035

EST. 1879

**S T A R K**

L U M B E R C O M P A N Y

FINE WOOD MOULDING

924 W. 1st. Avenue  
 Denver, CO 80223  
 303-534-8263 Phone  
 303-534-8266 Fax

|              |          |           |             |
|--------------|----------|-----------|-------------|
| Approved by: | MM/DD/YY |           |             |
| Drawn:       |          |           |             |
| File name:   |          | Scale 1:1 | Sheet 1-5-7 |

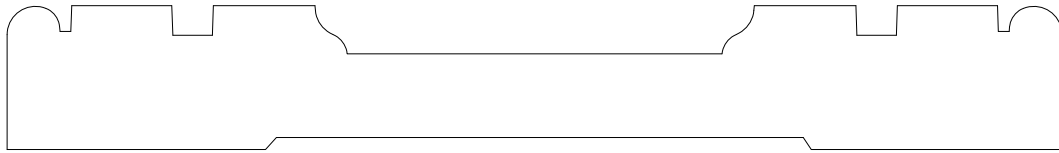

15036

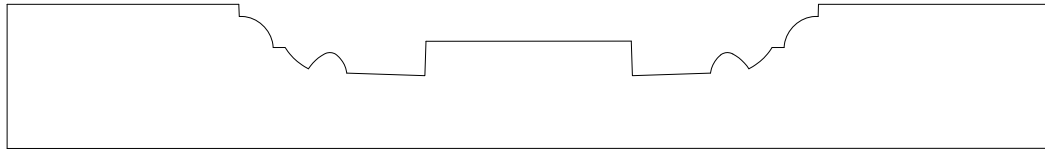

15037

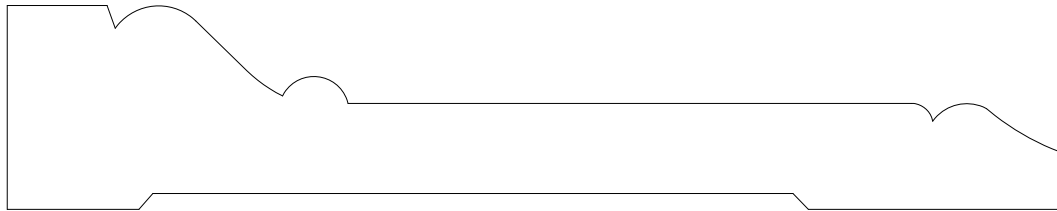

15038

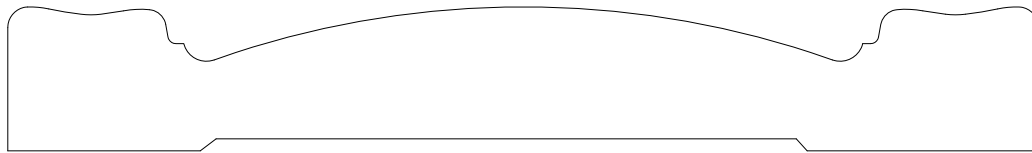

15039

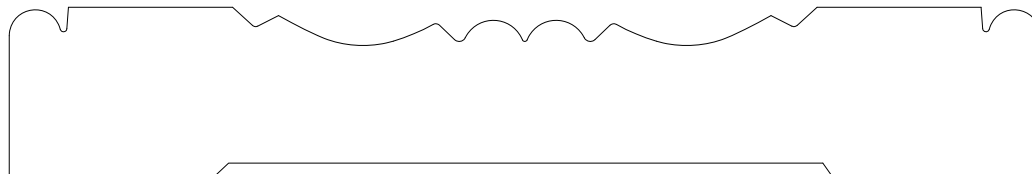

15040

EST. 1879

**S T A R K**

L U M B E R C O M P A N Y

FINE WOOD MOULDING

924 W. 1st. Avenue  
 Denver, CO 80223  
 303-534-8263 Phone  
 303-534-8266 Fax

|              |          |           |             |
|--------------|----------|-----------|-------------|
| Approved by: | MM/DD/YY |           |             |
| Drawn:       |          |           |             |
| File name:   |          | Scale 1:1 | Sheet 1-5-8 |

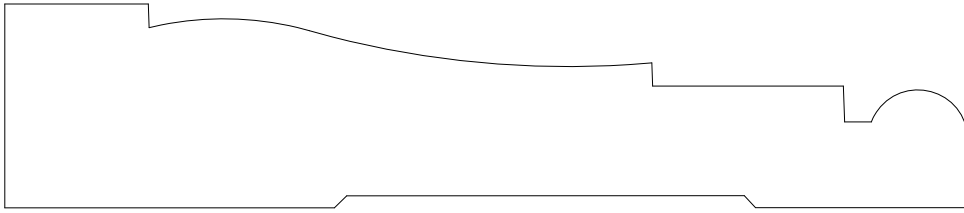

15041



15042

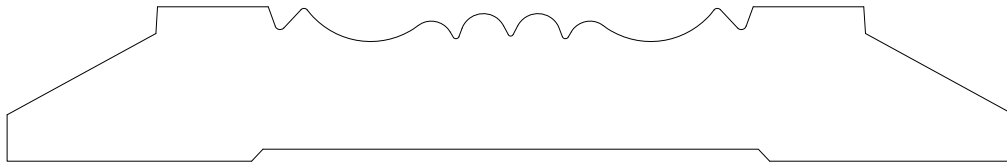

15043

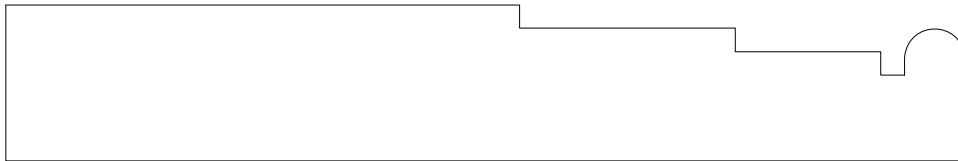

15044

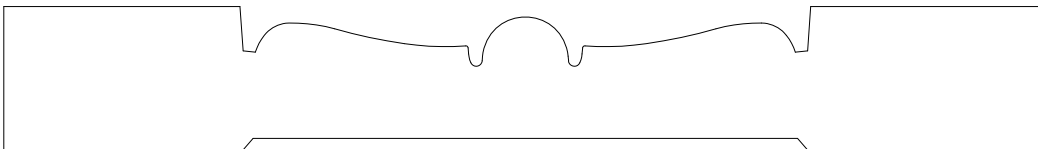

15045

EST. 1879

**S T A R K**

L U M B E R C O M P A N Y

FINE WOOD MOULDING

924 W. 1st. Avenue  
 Denver, CO 80223  
 303-534-8263 Phone  
 303-534-8266 Fax

|              |          |             |
|--------------|----------|-------------|
| Approved by: | MM/DD/YY |             |
| Drawn:       |          |             |
| File name:   |          | Scale 1:1   |
|              |          | Sheet 1-5-9 |

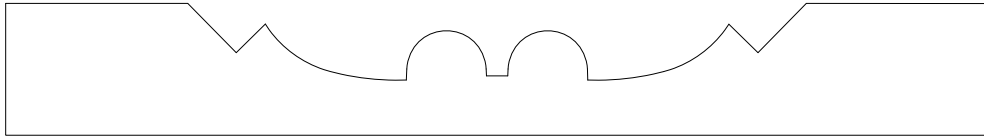

15050

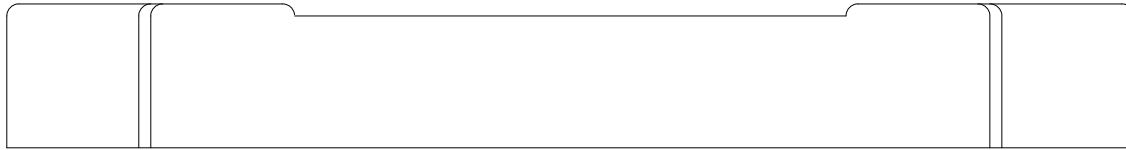

15056

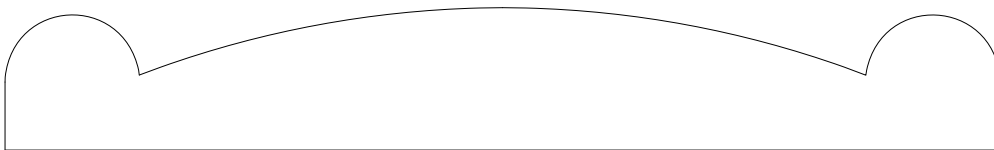

15057

EST. 1879  
**S T A R K**  
L U M B E R C O M P A N Y  
FINE WOOD MOULDING

924 W. 1st. Avenue  
Denver, CO 80223  
303-534-8263 Phone  
303-534-8266 Fax

|              |          |           |              |
|--------------|----------|-----------|--------------|
| Approved by: | MM/DD/YY |           |              |
| Drawn:       |          |           |              |
| File name:   |          | Scale 1:1 | Sheet 1-5-10 |

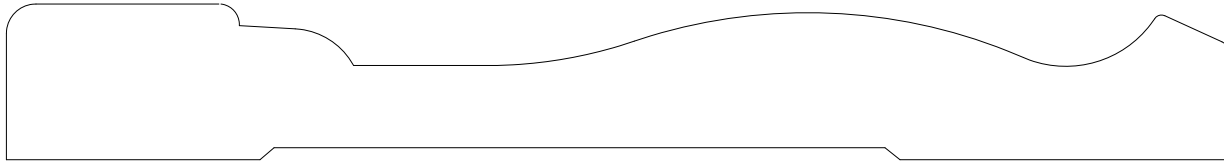

16001

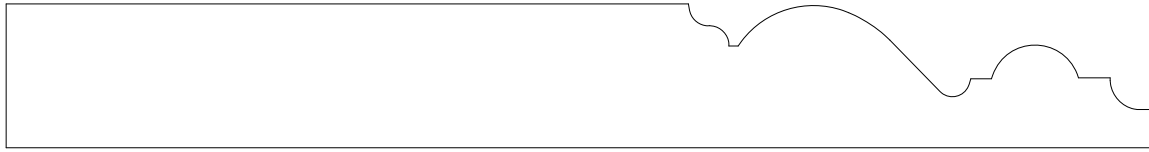

16008

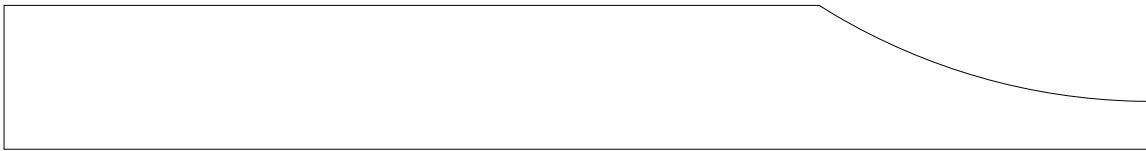

16027

|  |  |
|--|--|
|  | 924 W. 1st. Avenue<br>Denver, CO 80223<br>303-534-8263 Phone<br>303-534-8266 Fax |
|  |  |

|              |          |           |             |
|--------------|----------|-----------|-------------|
| Approved by: | MM/DD/YY |           |             |
| Drawn:       |          |           |             |
| File name:   |          | Scale 1:1 | Sheet 1-6-1 |

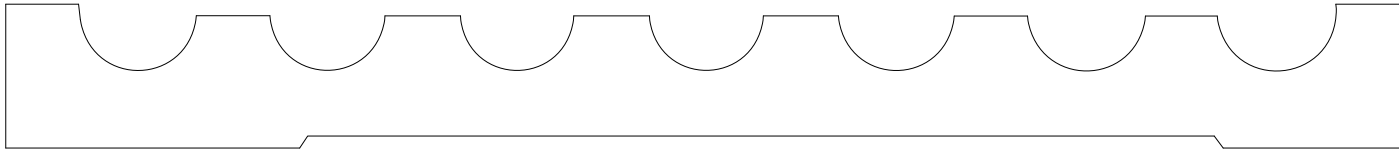

17001

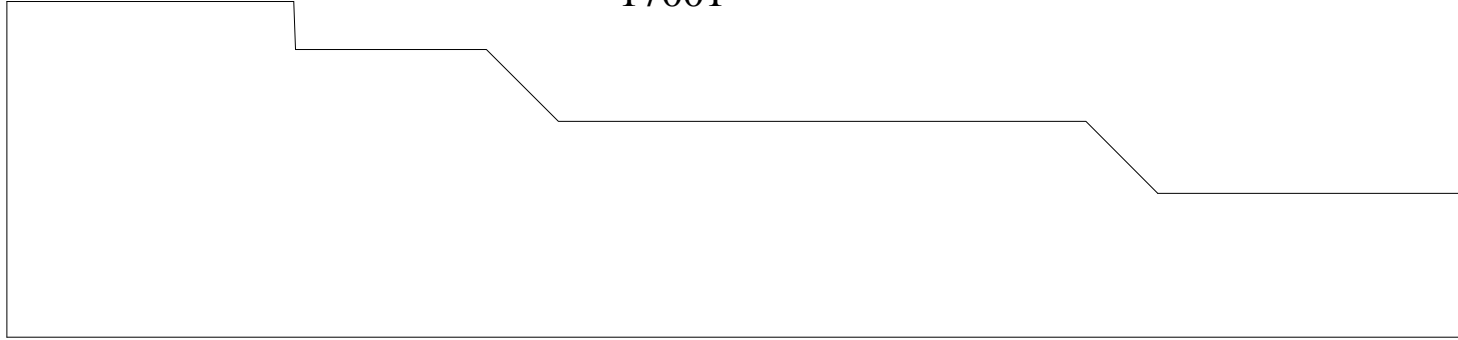

17055



18001

EST. 1879

**S T A R K**

L U M B E R C O M P A N Y

FINE WOOD MOULDING

924 W. 1st. Avenue  
 Denver, CO 80223  
 303-534-8263 Phone  
 303-534-8266 Fax

|              |          |           |             |
|--------------|----------|-----------|-------------|
| Approved by: | MM/DD/YY |           |             |
| Drawn:       |          |           |             |
| File name:   |          | Scale 1:1 | Sheet 1-7-1 |

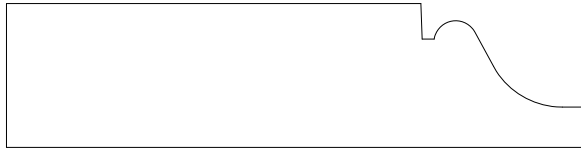

23001

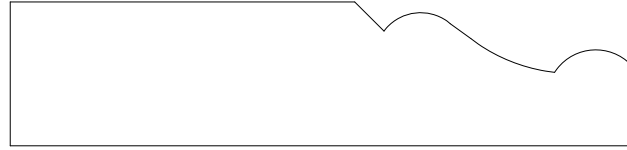

23007



23002



23008

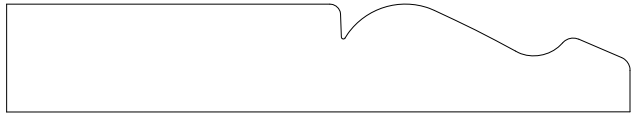

23003

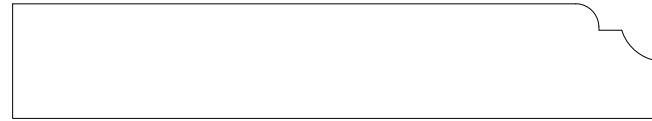

23009

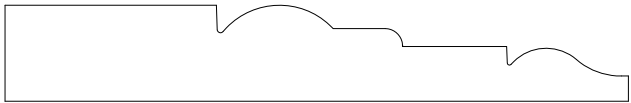

23004



23010



23005

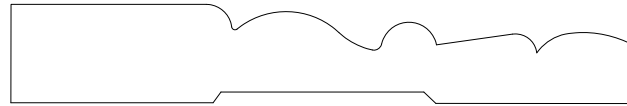

23011

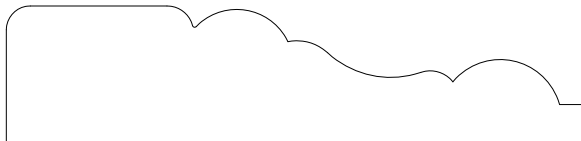

23006

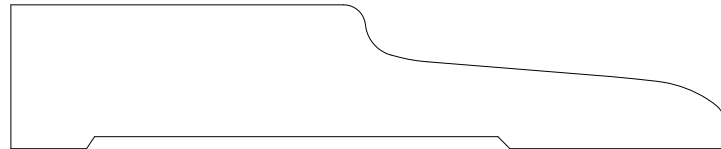

23012

EST. 1879

**S T A R K**

L U M B E R C O M P A N Y

FINE WOOD MOULDING

924 W. 1st. Avenue  
 Denver, CO 80223  
 303-534-8263 Phone  
 303-534-8266 Fax

|              |          |             |
|--------------|----------|-------------|
| Approved by: | MM/DD/YY |             |
| Drawn:       |          |             |
| File name:   |          | Scale 1:1   |
|              |          | Sheet 2-3-1 |



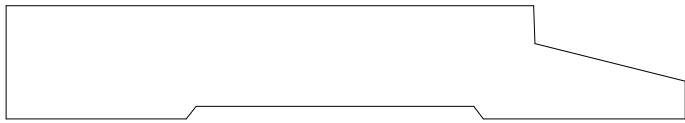

23013

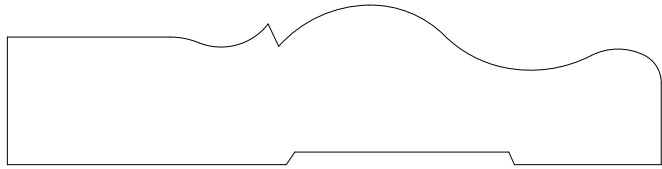

23014

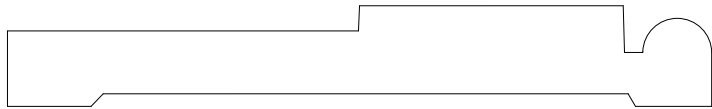

23015

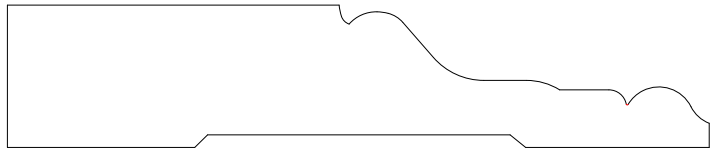

23016

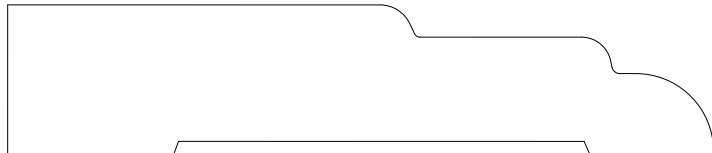

23017

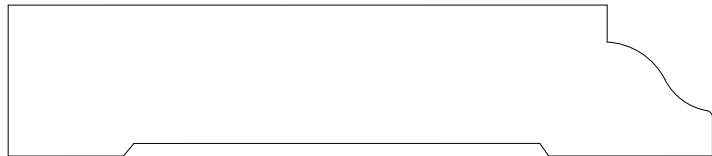

23018

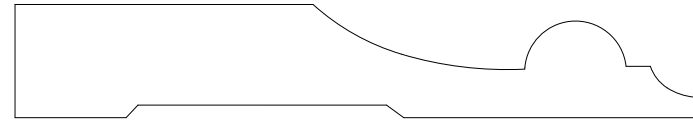

23019



23020

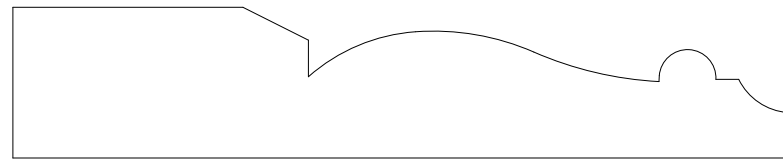

23021

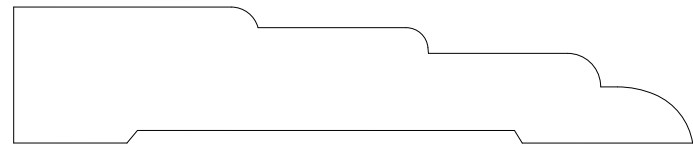

23022

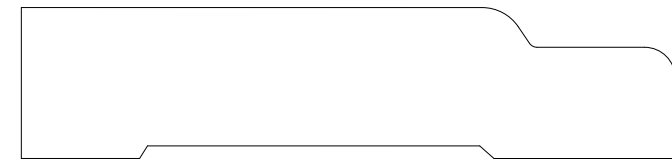

23023

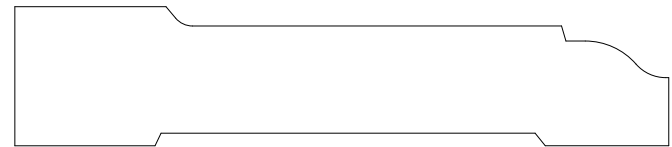

23024

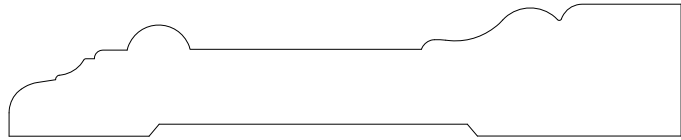

23025

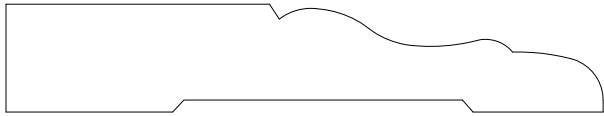

23026

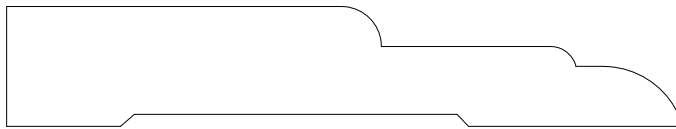

23027

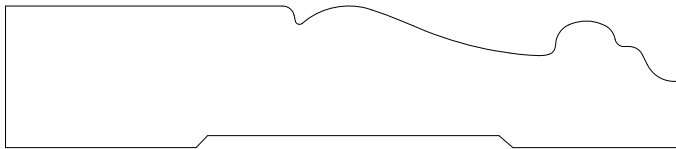

23028

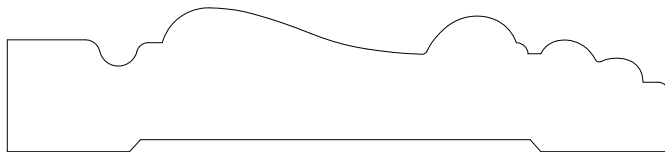

23029



23030

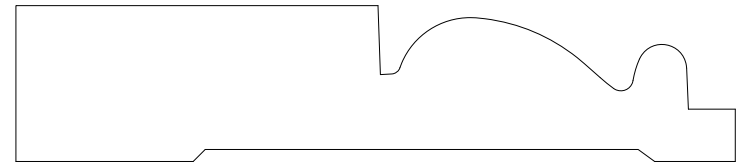

23031

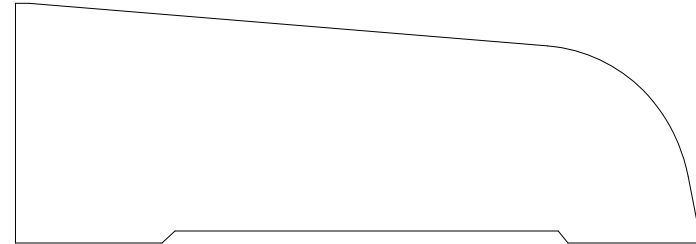

23032

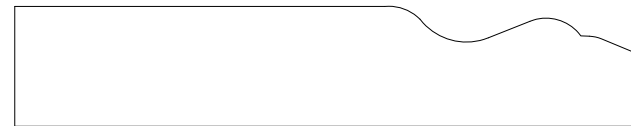

23033

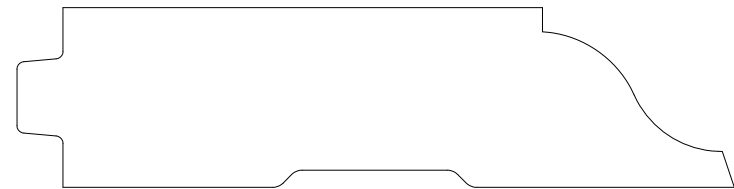

23034

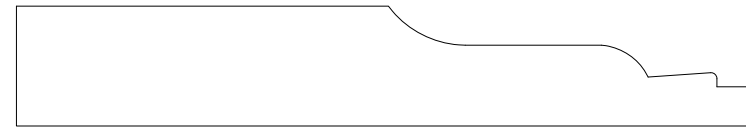

23041

EST. 1879

**S T A R K**

L U M B E R C O M P A N Y

FINE WOOD MOULDING

924 W. 1st. Avenue  
 Denver, CO 80223  
 303-534-8263 Phone  
 303-534-8266 Fax

|              |          |           |             |
|--------------|----------|-----------|-------------|
| Approved by: | MM/DD/YY |           |             |
| Drawn:       |          |           |             |
| File name:   |          | Scale 1:1 | Sheet 2-3-3 |

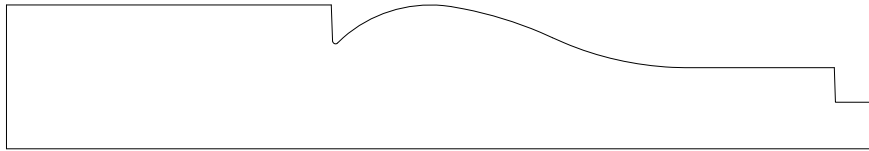

24001

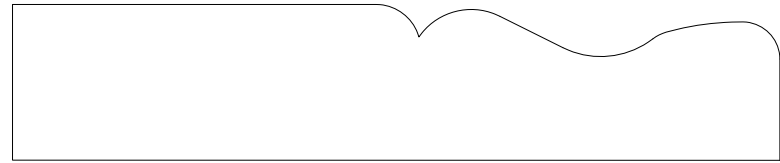

24006

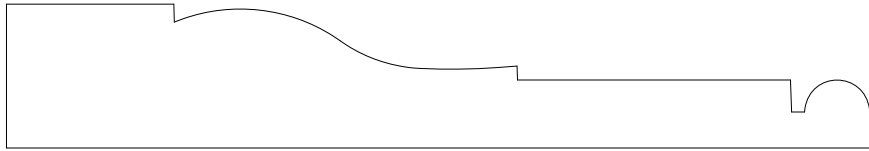

24002

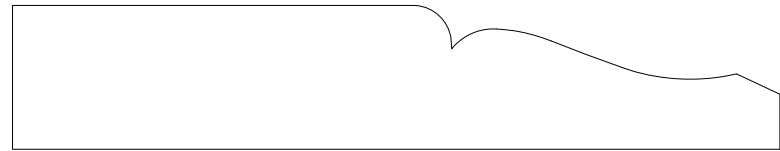

24007

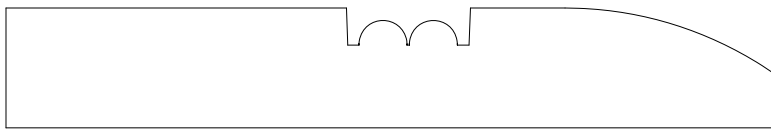

24003

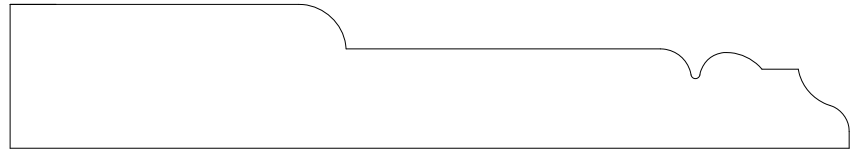

24008

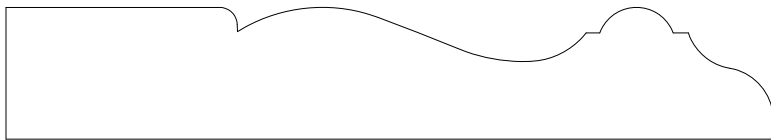

24004

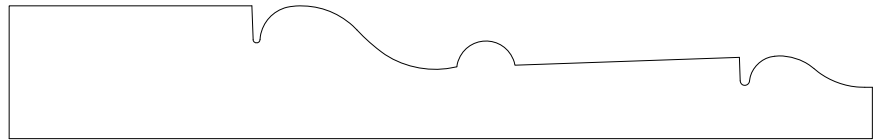

24009



24005

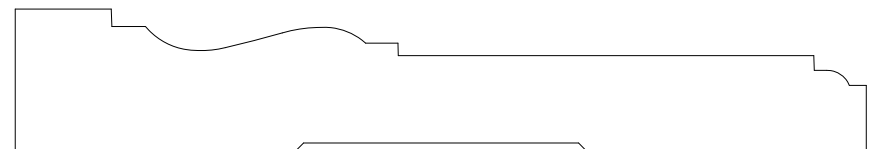

24010

|   |  |              |          |           |             |
|---|--|--------------|----------|-----------|-------------|
|  <p><b>S T A R K</b><br/>L U M B E R C O M P A N Y<br/>FINE WOOD MOULDING</p> | <p>924 W. 1st. Avenue<br/>Denver, CO 80223<br/>303-534-8263 Phone<br/>303-534-8266 Fax</p> | Approved by: | MM/DD/YY | Scale 1:1 | Sheet 2-4-1 |
|   |  | Drawn:       |          |           |             |
|   |  | File name:   |          |           |             |

|              |          |           |             |
|--------------|----------|-----------|-------------|
| Approved by: | MM/DD/YY | Scale 1:1 | Sheet 2-4-1 |
| Drawn:       |          |           |             |
| File name:   |          |           |             |

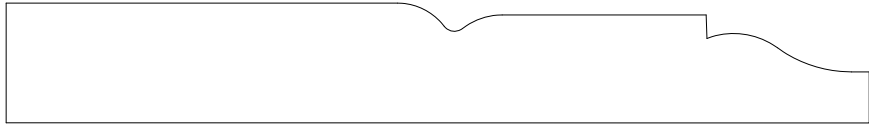

24011



24016

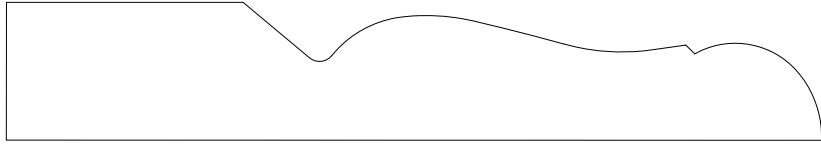

24012

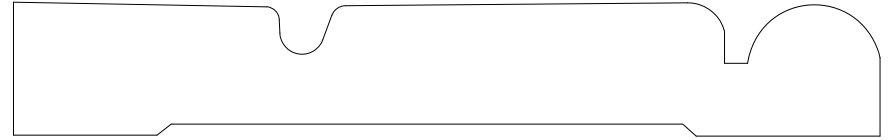

24017

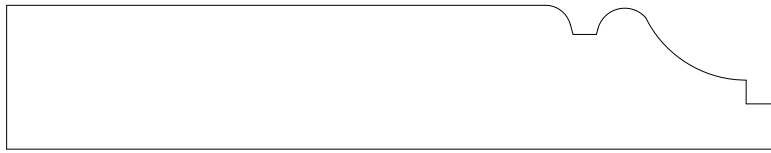

24013

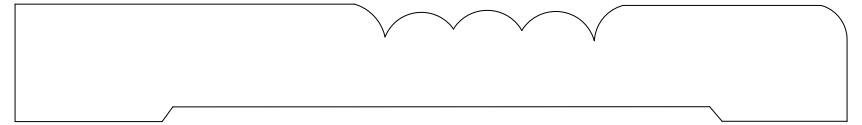

24018



24014



24019

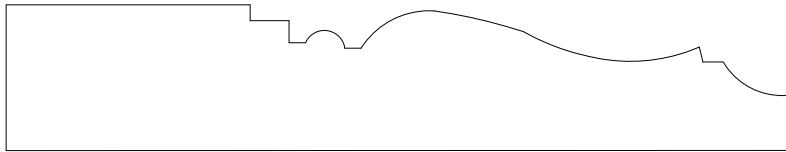

24015

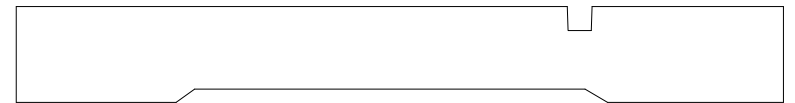

24020



924 W. 1st. Avenue  
Denver, CO 80223  
303-534-8263 Phone  
303-534-8266 Fax

|              |          |             |
|--------------|----------|-------------|
| Approved by: | MM/DD/YY |             |
| Drawn:       |          |             |
| File name:   |          | Scale 1:1   |
|              |          | Sheet 2-4-2 |



24021

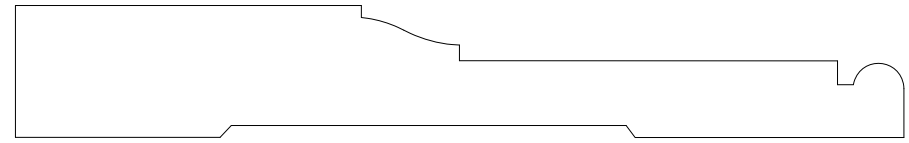

24026

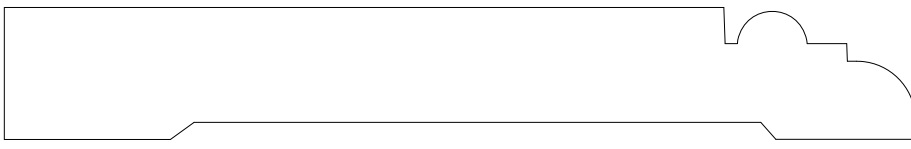

24022

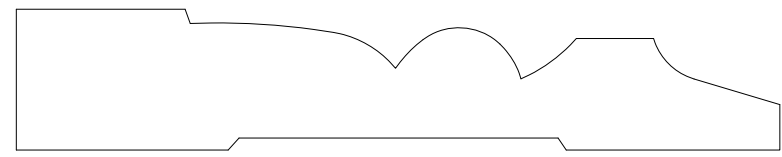

24027

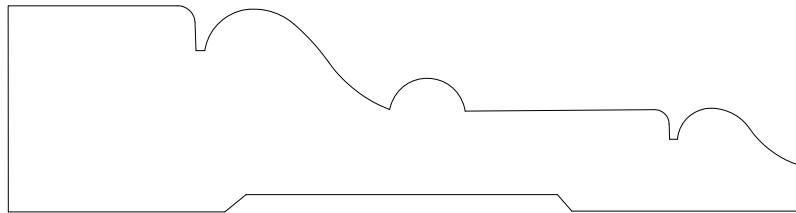

24023

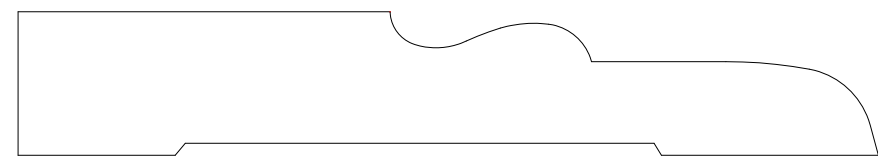

24028

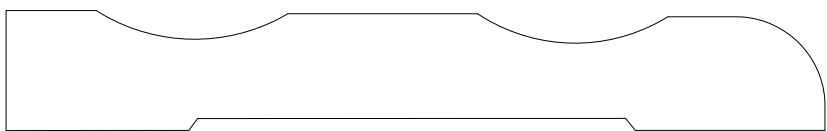

24024

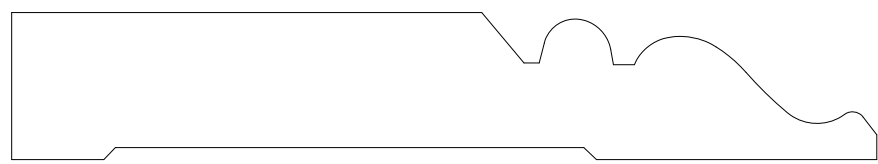

24029

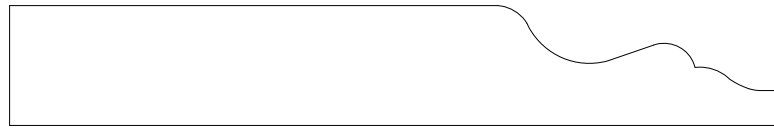

24025



24030

EST. 1879

**S T A R K**

L U M B E R C O M P A N Y

FINE WOOD MOULDING

924 W. 1st. Avenue  
 Denver, CO 80223  
 303-534-8263 Phone  
 303-534-8266 Fax

|              |          |
|--------------|----------|
| Approved by: | MM/DD/YY |
| Drawn:       |          |
| File name:   |          |

Scale 1:1

Sheet 2-4-3

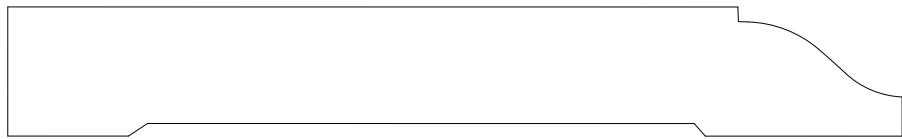

24031

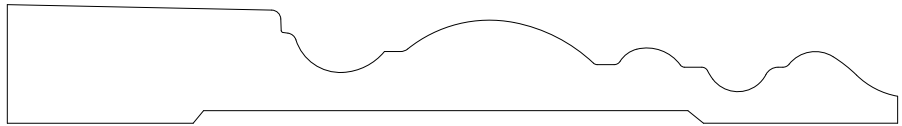

24032

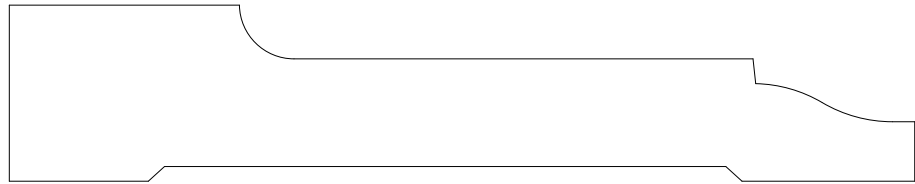

24033



24034

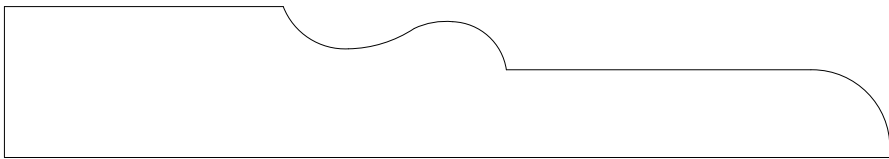

24035

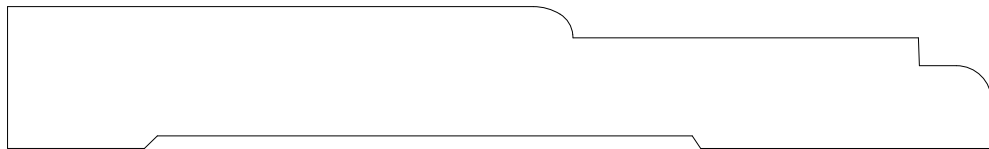

24036

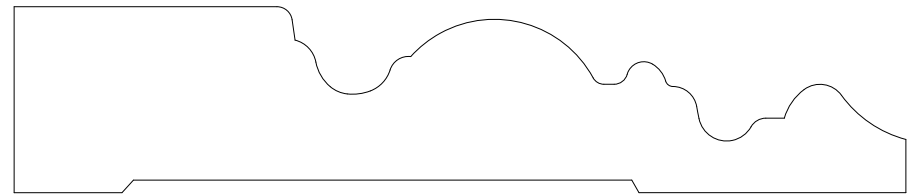

24037

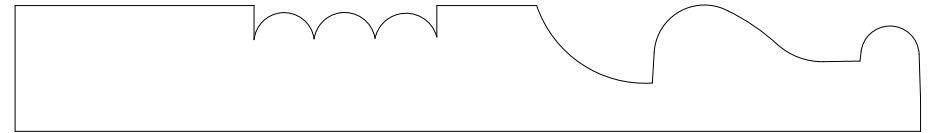

24038

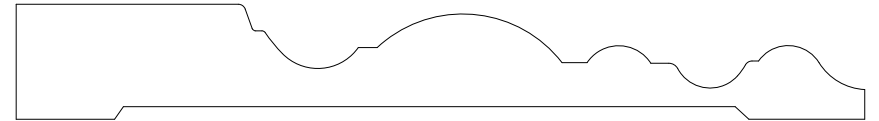

24039

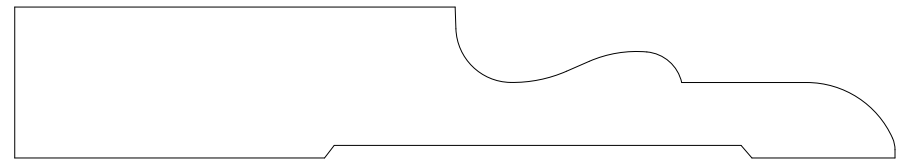

24040

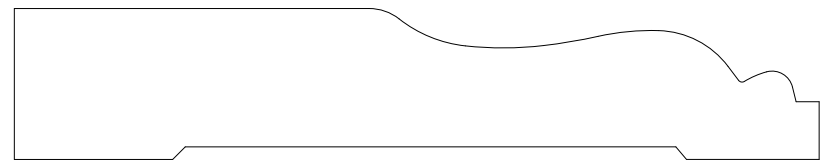

24041

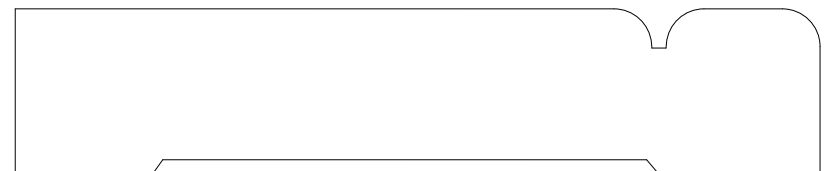

24042

|  |   |
|--|---|
|  | 924 W. 1st. Avenue<br>Denver, CO 80223<br>303-534-8263<br>Phone |
|  | 303-534-8266 Fax  |

|  |
|--|
|  |
|--|

|              |          |
|--------------|----------|
| Approved by: | MM/DD/YY |
| Drawn:       |          |
| File name:   |          |

|           |             |
|-----------|-------------|
| Scale 1:1 | Sheet 2-4-4 |
|-----------|-------------|

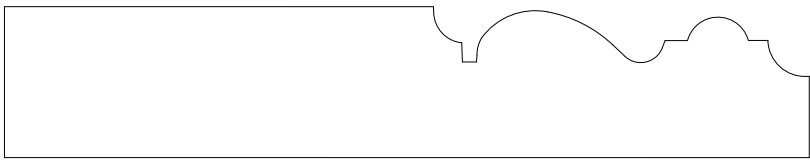

24043

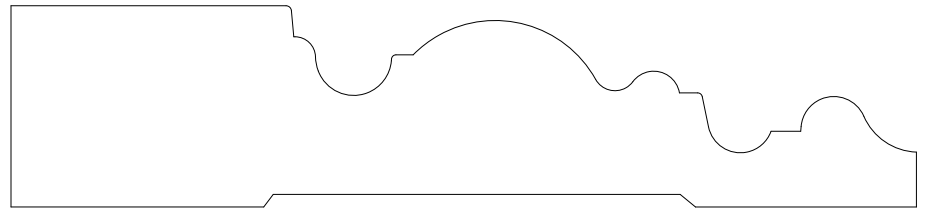

24049

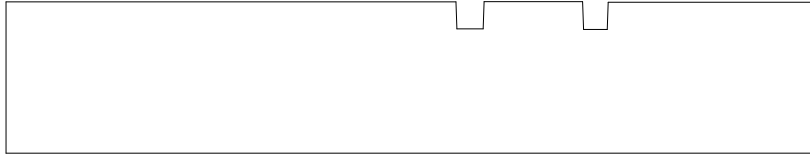

24044



24050



24045

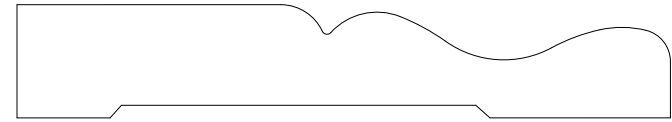

24051

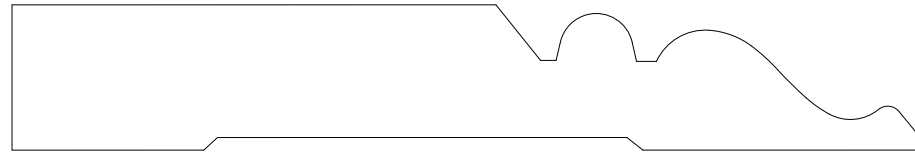

24046



24052

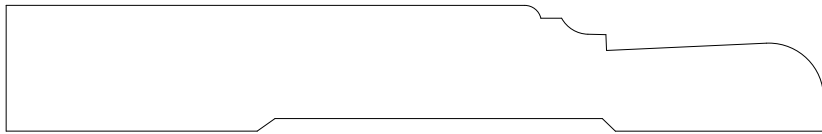

24047

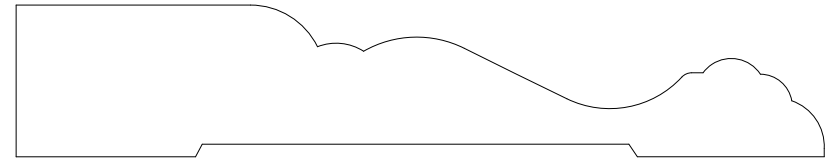

24053



24048

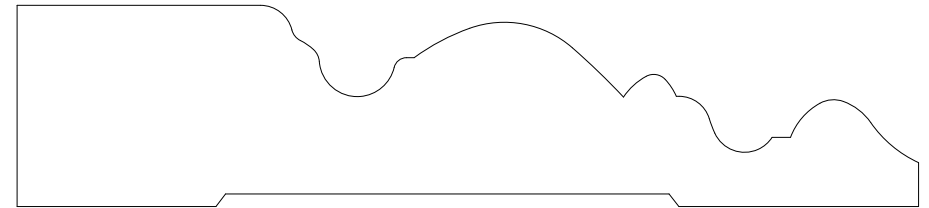

24054

|  |   |
|--|---|
|  | 924 W. 1st. Avenue<br>Denver, CO 80223<br>303-534-8263<br>Phone |
|  | 303-534-8266 Fax  |

|  |
|--|
|  |
|--|

|              |          |
|--------------|----------|
| Approved by: | MM/DD/YY |
| Drawn:       |          |
| File name:   |          |

|  |           |             |
|--|-----------|-------------|
|  | Scale 1:1 | Sheet 2-4-5 |
|--|-----------|-------------|

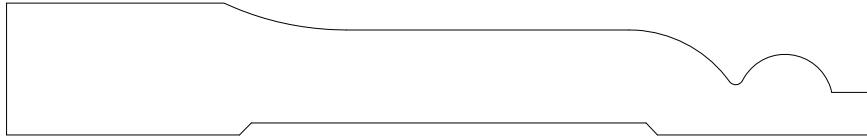

24055

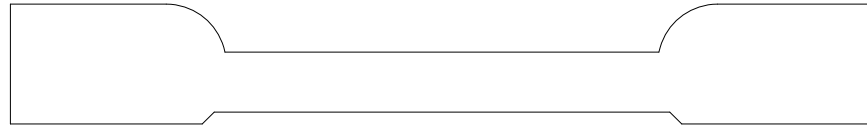

24056

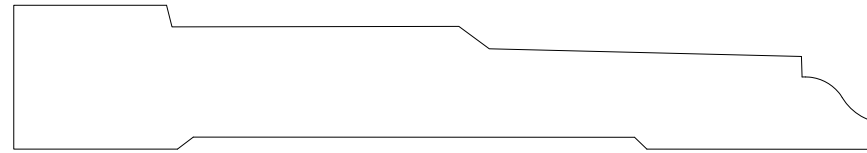

24057



24058

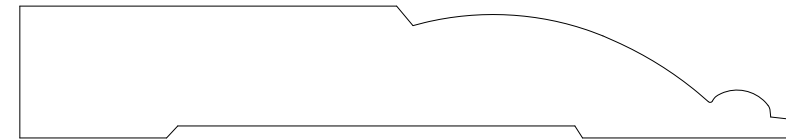

24059



24060



24061

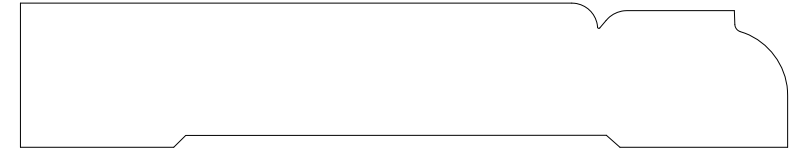

24062

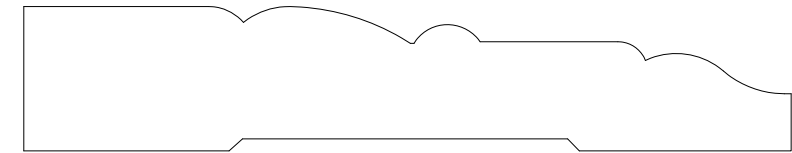

24063

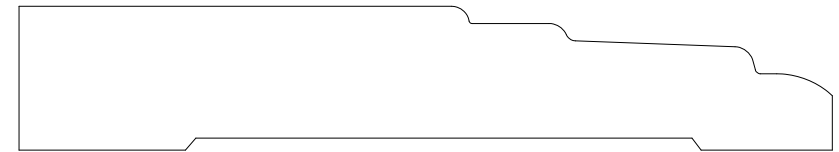

24064

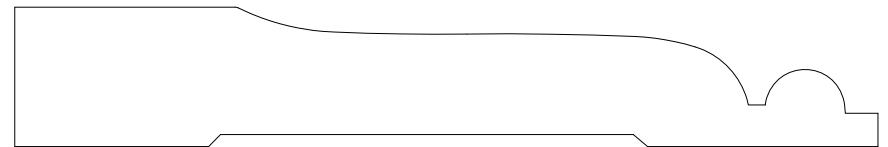

24065

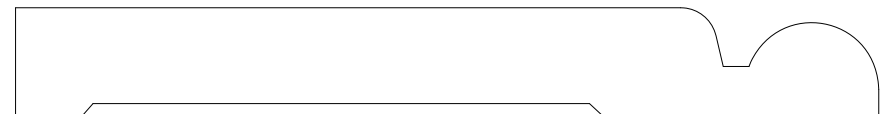

24066

EST. 1879

**S T A R K**

L U M B E R C O M P A N Y

FINE WOOD MOULDING

924 W. 1st. Avenue  
 Denver, CO 80223  
 303-534-8263 Phone  
 303-534-8266 Fax

|              |          |           |             |
|--------------|----------|-----------|-------------|
| Approved by: | MM/DD/YY |           |             |
| Drawn:       |          |           |             |
| File name:   |          | Scale 1:1 | Sheet 2-4-6 |



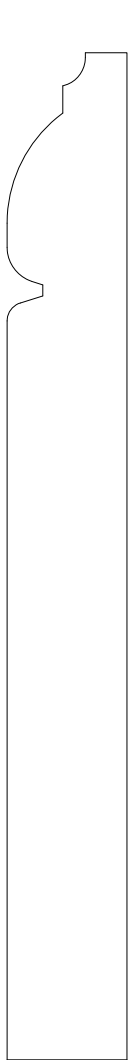

25001

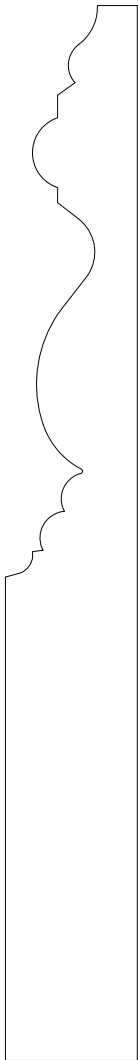

25002

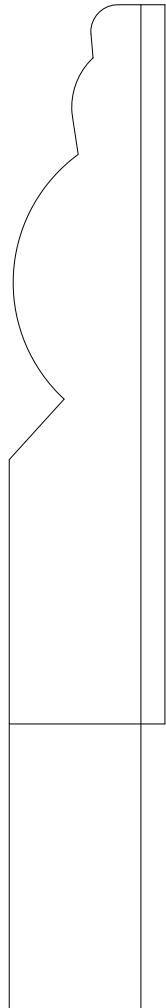

25003



25004

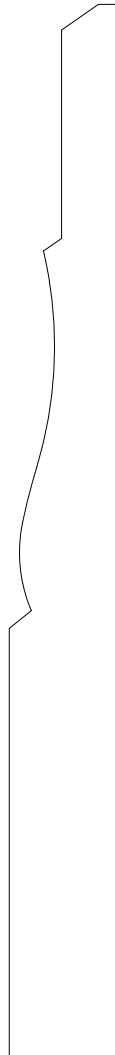

25005

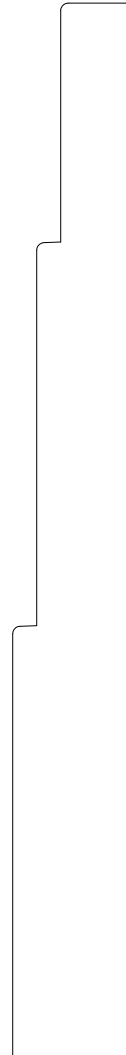

25006



25007

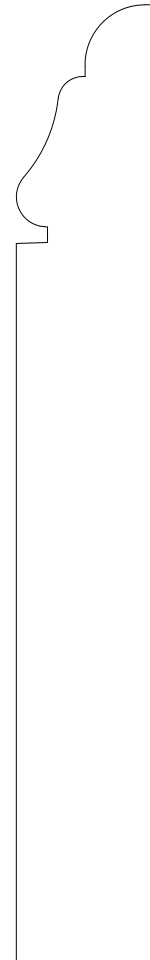

25008

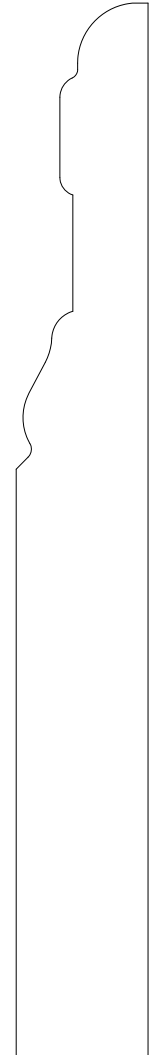

25009

EST. 1879

**S T A R K**

L U M B E R C O M P A N Y

FINE WOOD MOULDING

924 W. 1st. Avenue  
 Denver, CO 80223  
 303-534-8263 Phone  
 303-534-8266 Fax

|              |          |
|--------------|----------|
| Approved by: | MM/DD/YY |
| Drawn:       |          |
| File name:   |          |

|           |             |
|-----------|-------------|
| Scale 1:1 | Sheet 2-5-1 |
|-----------|-------------|

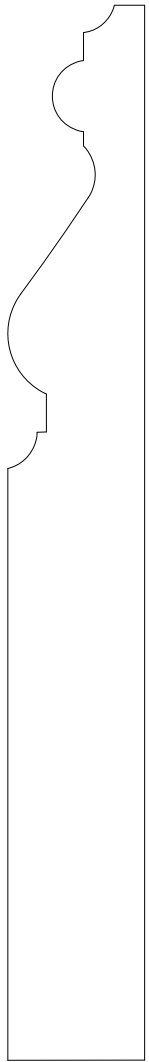

25010

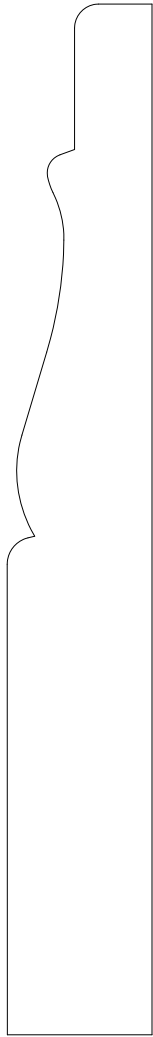

25011

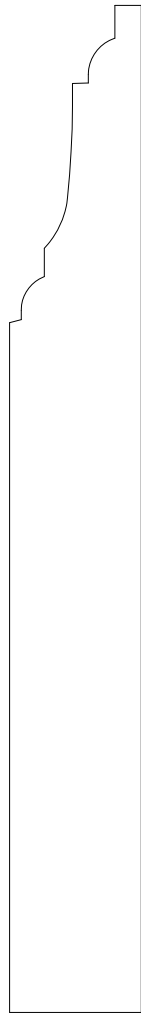

25012

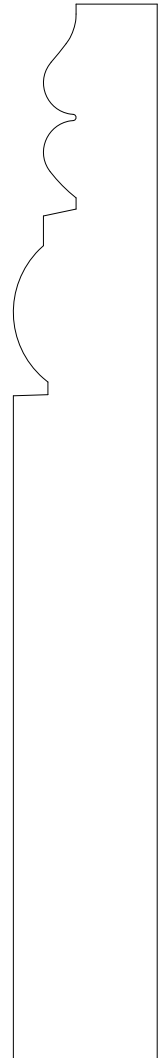

25013

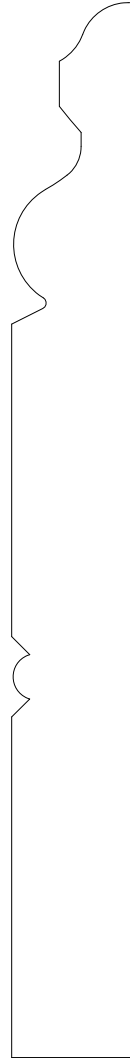

25014

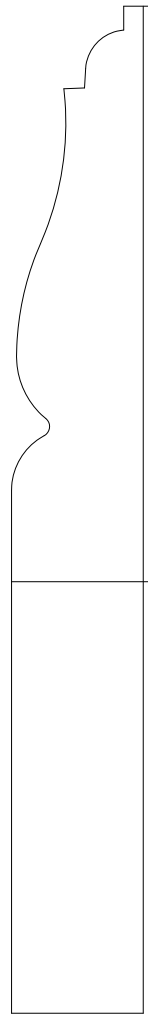

25015

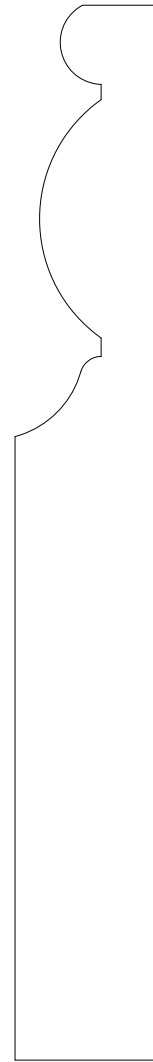

25016

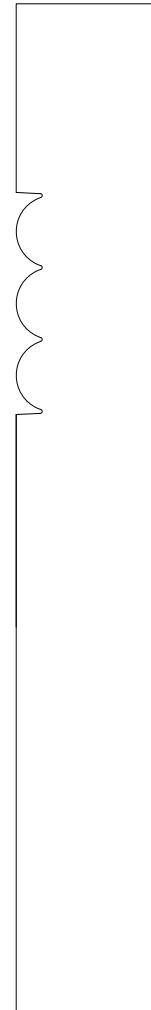

25017

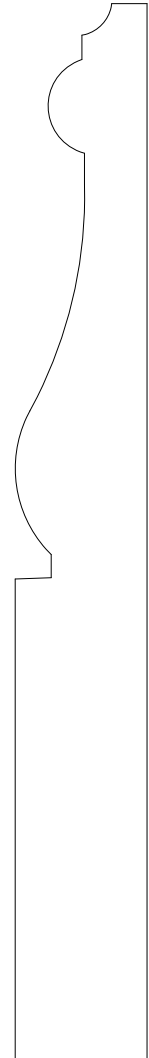

25018

EST. 1879

**S T A R K**

L U M B E R C O M P A N Y

FINE WOOD MOULDING

924 W. 1st. Avenue  
 Denver, CO 80223  
 303-534-8263 Phone  
 303-534-8266 Fax

|              |          |             |
|--------------|----------|-------------|
| Approved by: | MM/DD/YY |             |
| Drawn:       |          |             |
| File name:   |          | Scale 1:1   |
|              |          | Sheet 2-5-2 |

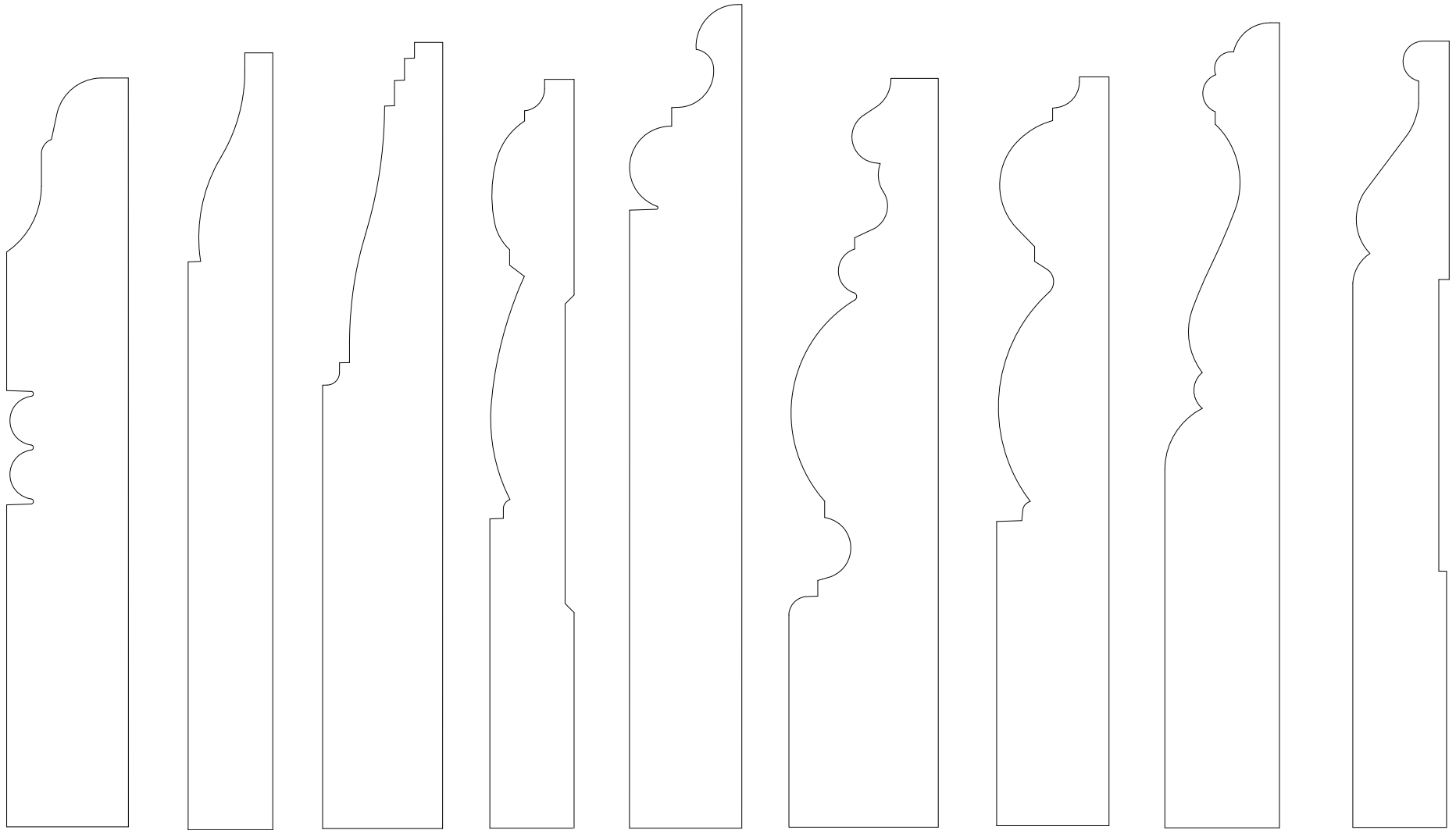

25019

25020

25021

25022

25023

25024

25025

25026

25027

EST. 1879

**S T A R K**

L U M B E R C O M P A N Y

FINE WOOD MOULDING

924 W. 1st. Avenue  
 Denver, CO 80223  
 303-534-8263 Phone  
 303-534-8266 Fax

|              |          |             |
|--------------|----------|-------------|
| Approved by: | MM/DD/YY |             |
| Drawn:       |          |             |
| File name:   |          | Scale 1:1   |
|              |          | Sheet 2-5-3 |

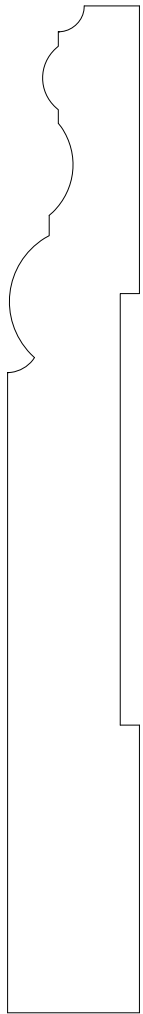

25028

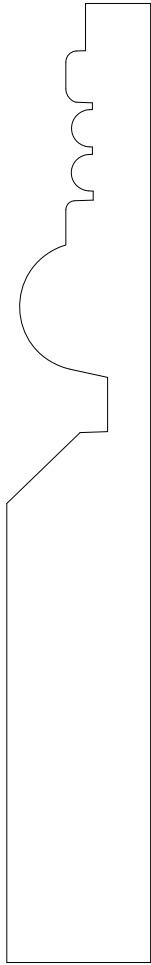

25029

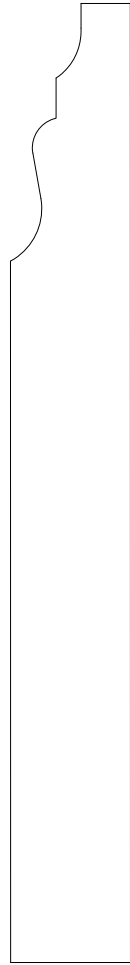

25030

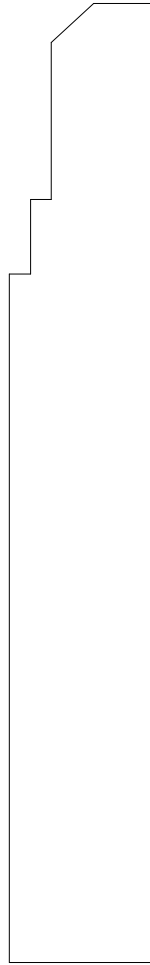

25031

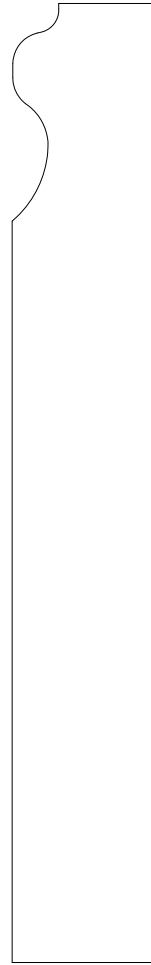

25032



25033



25034



25035

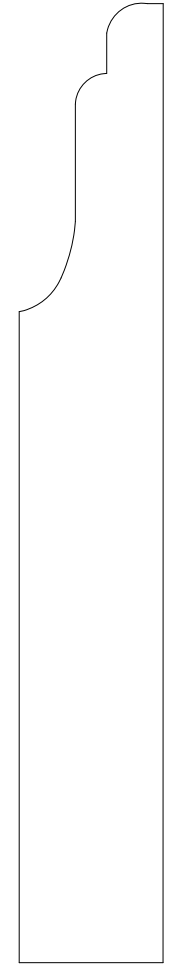

25036

EST. 1879

**S T A R K**

L U M B E R C O M P A N Y

FINE WOOD MOULDING

924 W. 1st. Avenue  
 Denver, CO 80223  
 303-534-8263 Phone  
 303-534-8266 Fax

|              |          |             |
|--------------|----------|-------------|
| Approved by: | MM/DD/YY |             |
| Drawn:       |          |             |
| File name:   |          | Scale 1:1   |
|              |          | Sheet 2-5-4 |

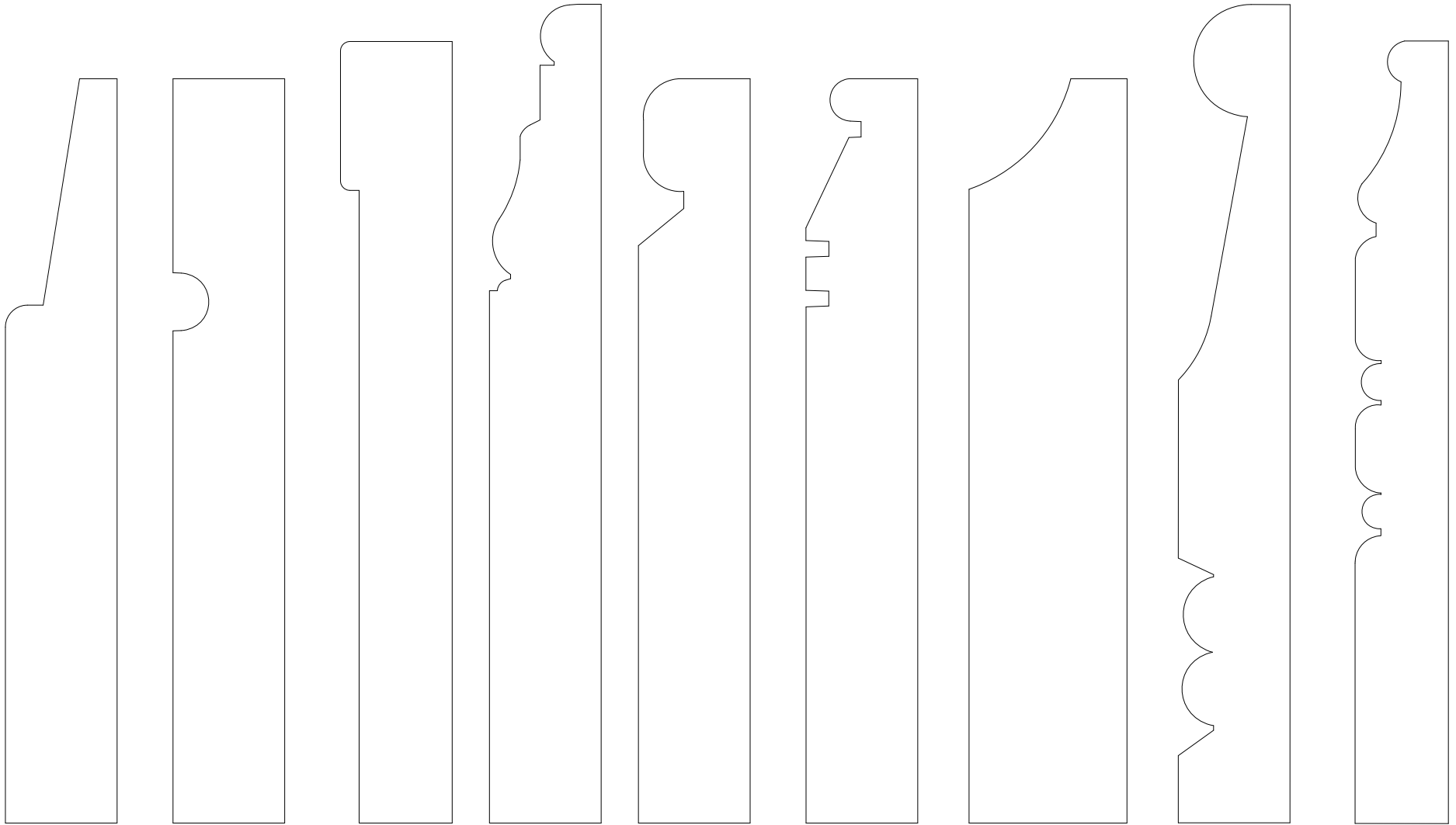

25037

25038

25039

25040

25041

25042

25043

25044

25045

EST. 1879

**S T A R K**

L U M B E R C O M P A N Y

FINE WOOD MOULDING

924 W. 1st. Avenue  
 Denver, CO 80223  
 303-534-8263 Phone  
 303-534-8266 Fax

|              |          |             |
|--------------|----------|-------------|
| Approved by: | MM/DD/YY |             |
| Drawn:       |          |             |
| File name:   |          | Scale 1:1   |
|              |          | Sheet 2-5-5 |

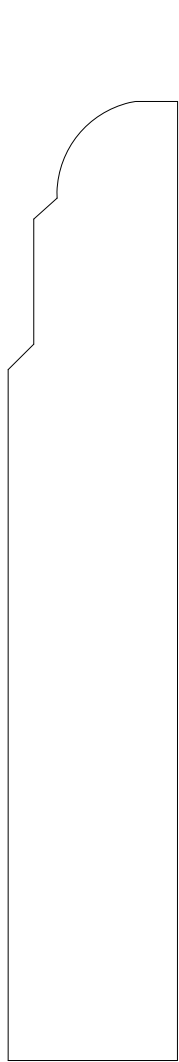

25046

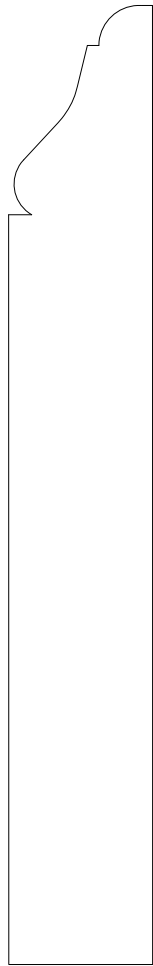

25047

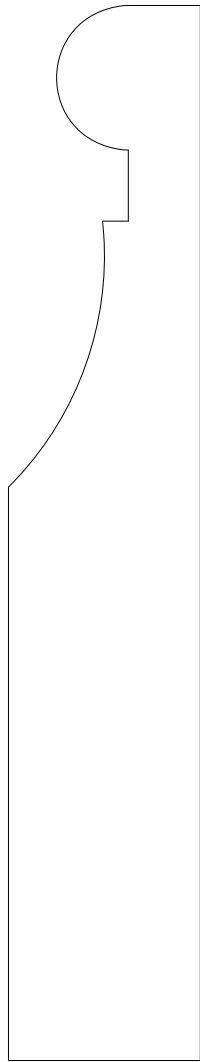

25048



25049



25050

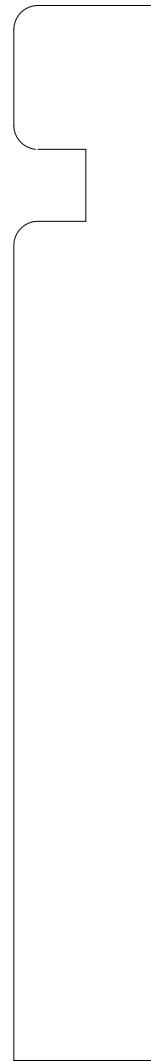

25051

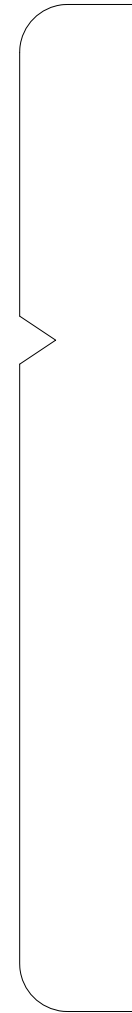

25052

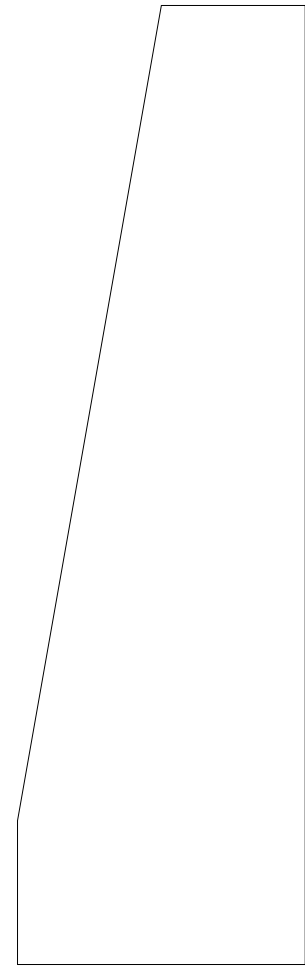

25053

|   |   |
|---|---|
| <p>EST. 1879</p> <p><b>S T A R K</b></p> <p>L U M B E R C O M P A N Y</p> <p>FINE WOOD MOULDING</p> | <p>924 W. 1st. Avenue<br/>         Denver, CO 80223<br/>         303-534-8263 Phone<br/>         303-534-8266 Fax</p> |
|---|---|

|              |          |
|--------------|----------|
| Approved by: | MM/DD/YY |
| Drawn:       |          |
| File name:   |          |

Scale 1:1

Sheet 2-5-6

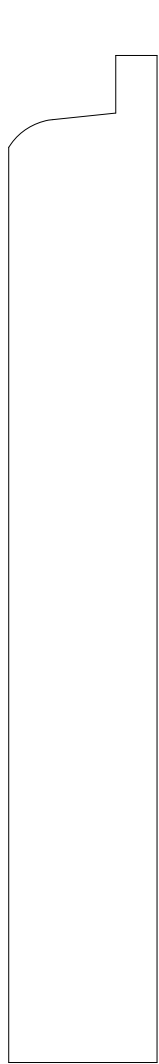

25054

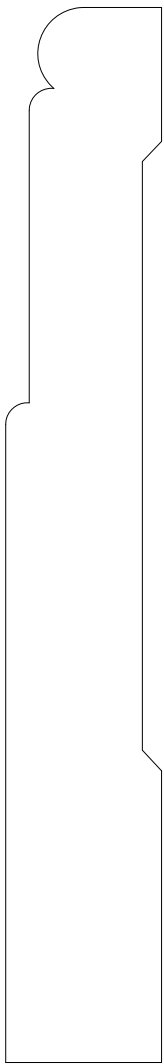

25055

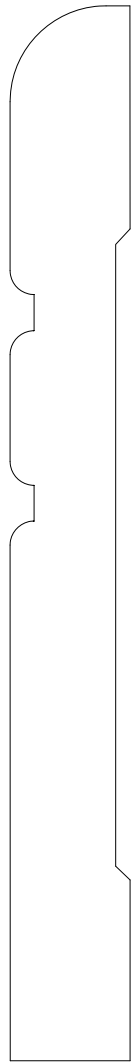

25056

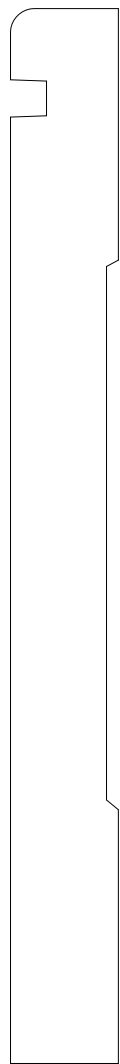

25057

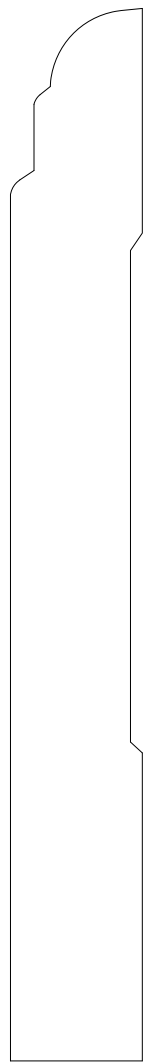

25058

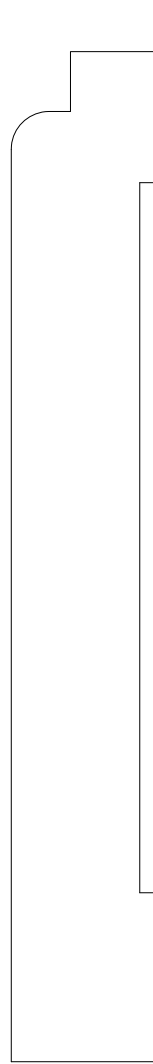

25059

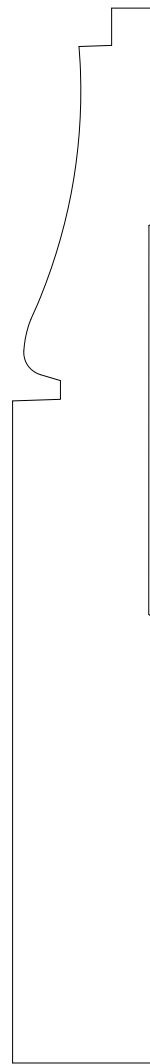

25060

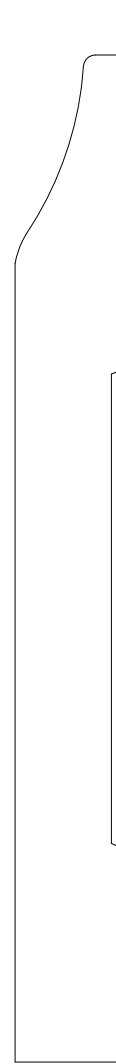

25061

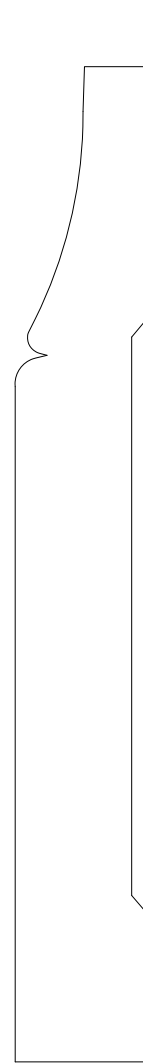

25062

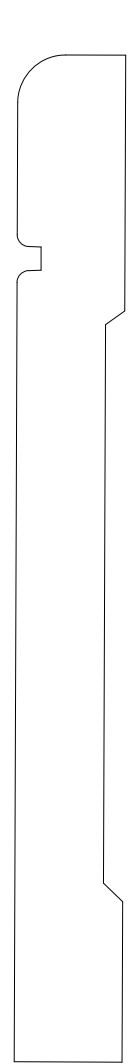

25063

EST. 1879

**S T A R K**

L U M B E R C O M P A N Y

FINE WOOD MOULDING

924 W. 1st. Avenue  
 Denver, CO 80223  
 303-534-8263 Phone  
 303-534-8266 Fax

|              |          |             |
|--------------|----------|-------------|
| Approved by: | MM/DD/YY |             |
| Drawn:       |          |             |
| File name:   |          | Scale 1:1   |
|              |          | Sheet 2-5-7 |

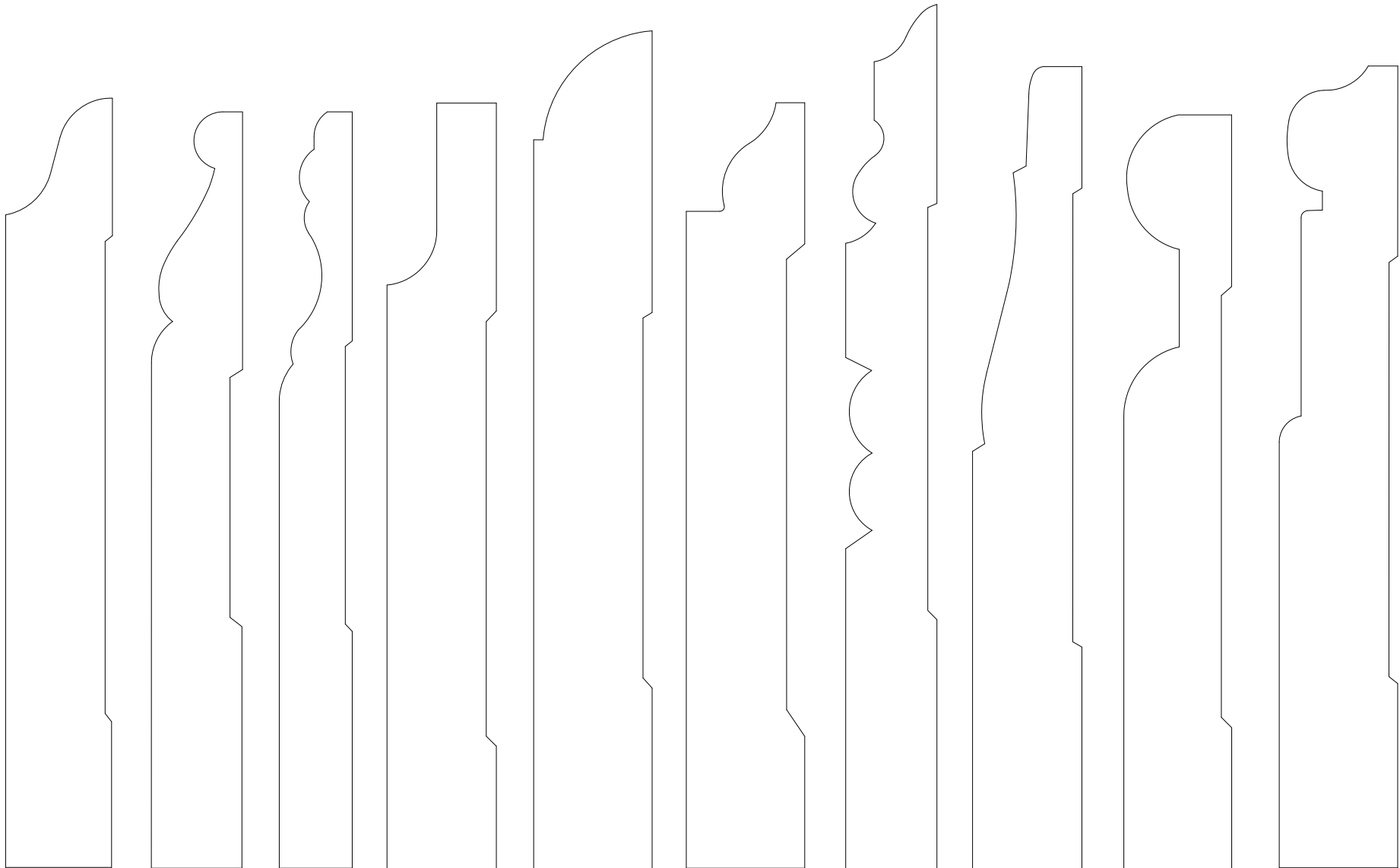

25064

25065

25066

25067

25068

25069

25070

25071

25072

25073

EST. 1879

**S T A R K**

L U M B E R C O M P A N Y

FINE WOOD MOULDING

924 W. 1st. Avenue  
 Denver, CO 80223  
 303-534-8263 Phone  
 303-534-8266 Fax

Approved by:

Drawn:

File name:

MM/DD/YY

Scale 1:1

Sheet 2-5-8



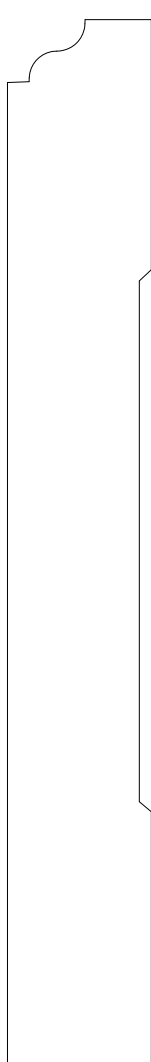

25074

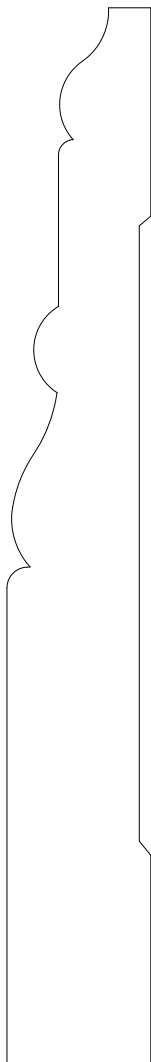

25075

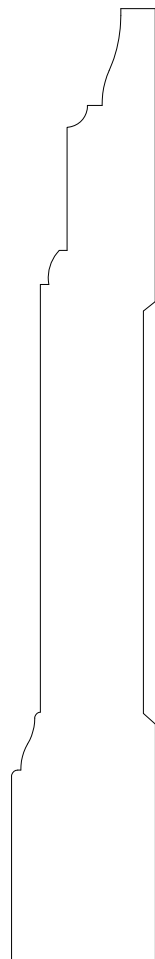

25076

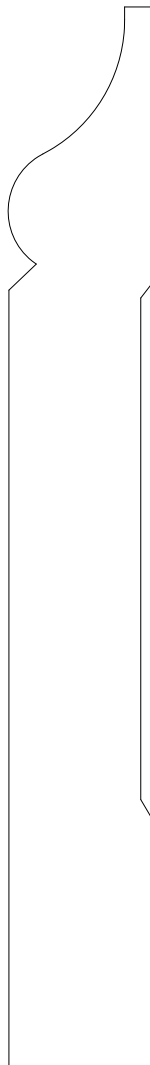

25077

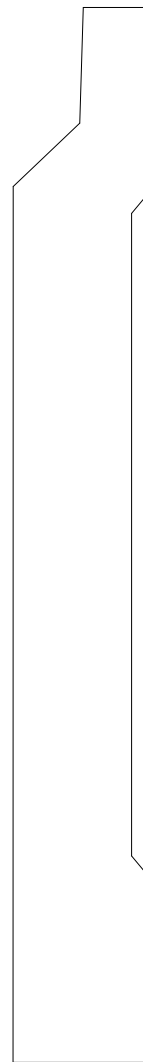

25078

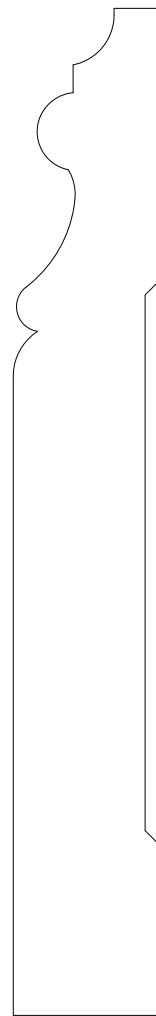

25079

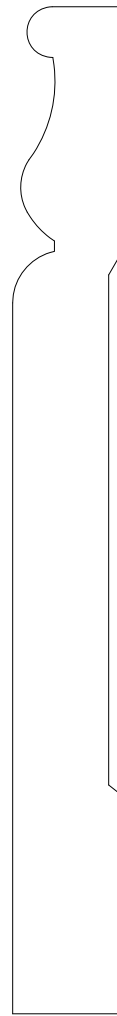

25080

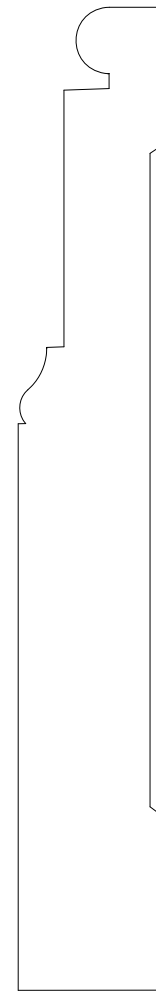

25081

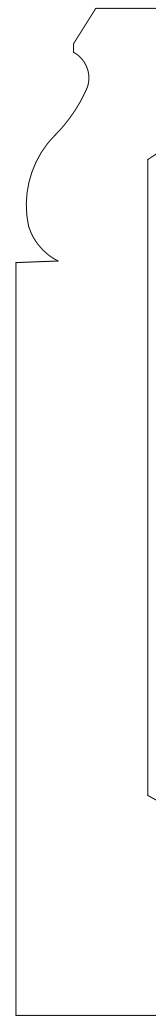

25082

EST. 1879

**S T A R K**

L U M B E R C O M P A N Y

FINE WOOD MOULDING

924 W. 1st. Avenue  
 Denver, CO 80223  
 303-534-8263 Phone  
 303-534-8266 Fax

|              |          |                       |
|--------------|----------|-----------------------|
| Approved by: | MM/DD/YY |                       |
| Drawn:       |          |                       |
| File name:   |          | Scale 1:1 Sheet 2-5-9 |

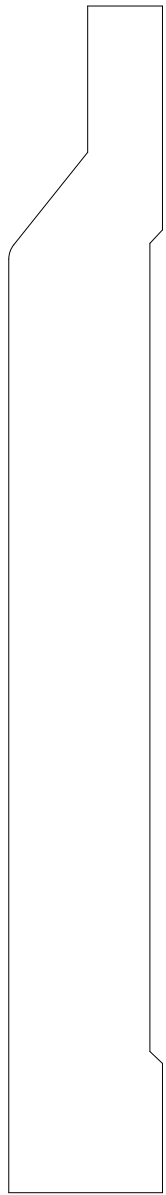

25083

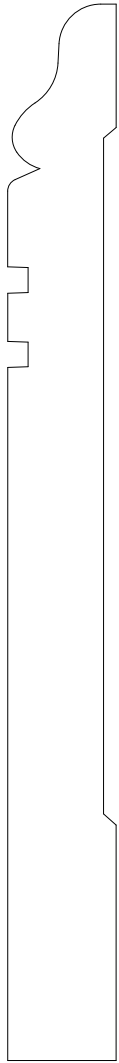

25084

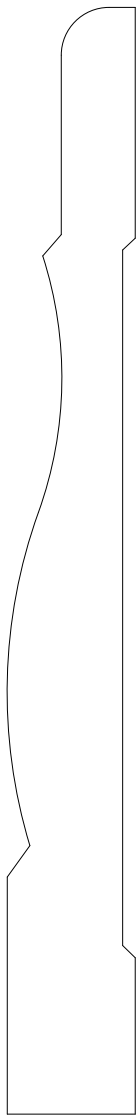

25085

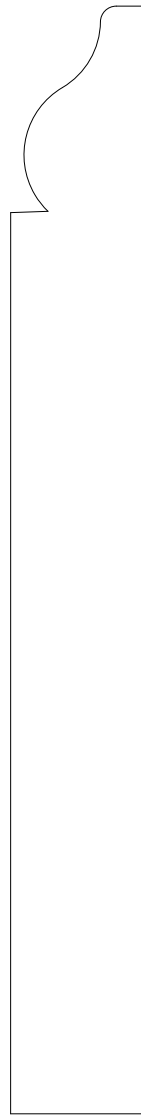

25086

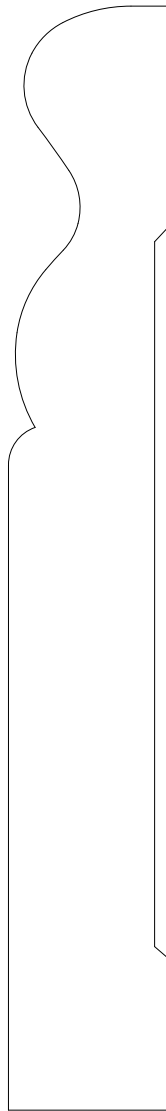

25087

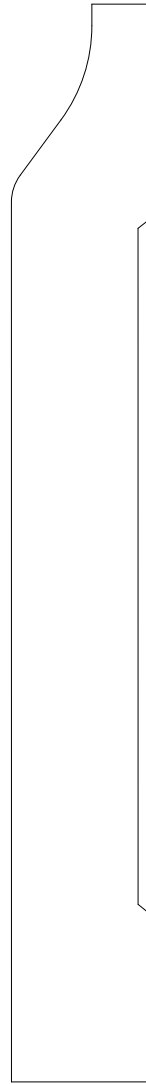

25088



25089

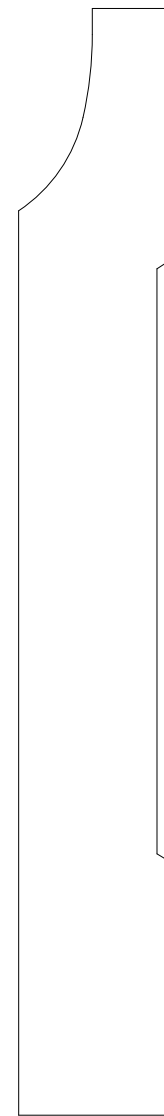

25090

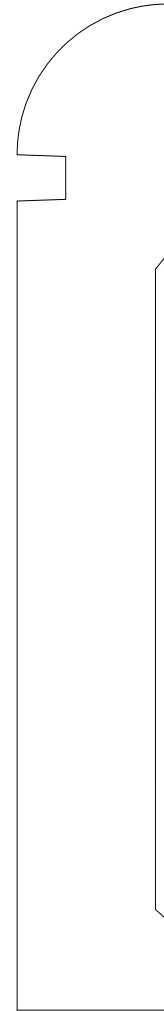

25091

|  |   |
|--|---|
|  | 924 W. 1st. Avenue<br>Denver, CO 80223<br>303-534-8263<br>Phone |
|  | 303-534-8266 Fax  |

|  |
|--|
|  |
|--|

|              |          |
|--------------|----------|
| Approved by: | MM/DD/YY |
| Drawn:       |          |
| File name:   |          |

|           |              |
|-----------|--------------|
| Scale 1:1 | Sheet 2-5-10 |
|-----------|--------------|

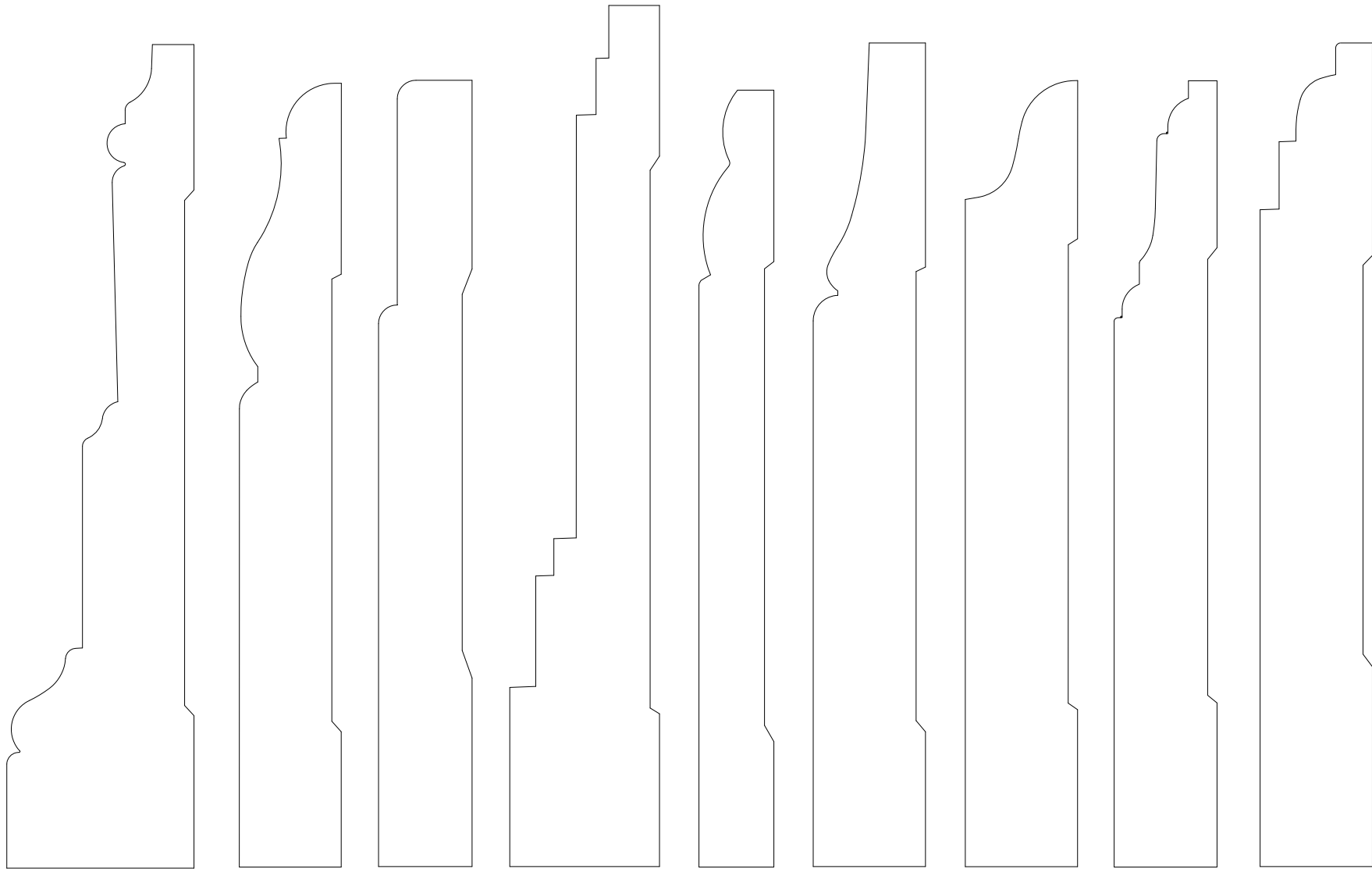

25092

25093

25094

25095

25096

25097

25098

25099

25100

EST. 1879

**S T A R K**

L U M B E R C O M P A N Y

FINE WOOD MOULDING

924 W. 1st. Avenue  
 Denver, CO 80223  
 303-534-8263 Phone  
 303-534-8266 Fax

|              |          |                        |
|--------------|----------|------------------------|
| Approved by: | MM/DD/YY |                        |
| Drawn:       |          |                        |
| File name:   |          | Scale 1:1 Sheet 2-5-11 |

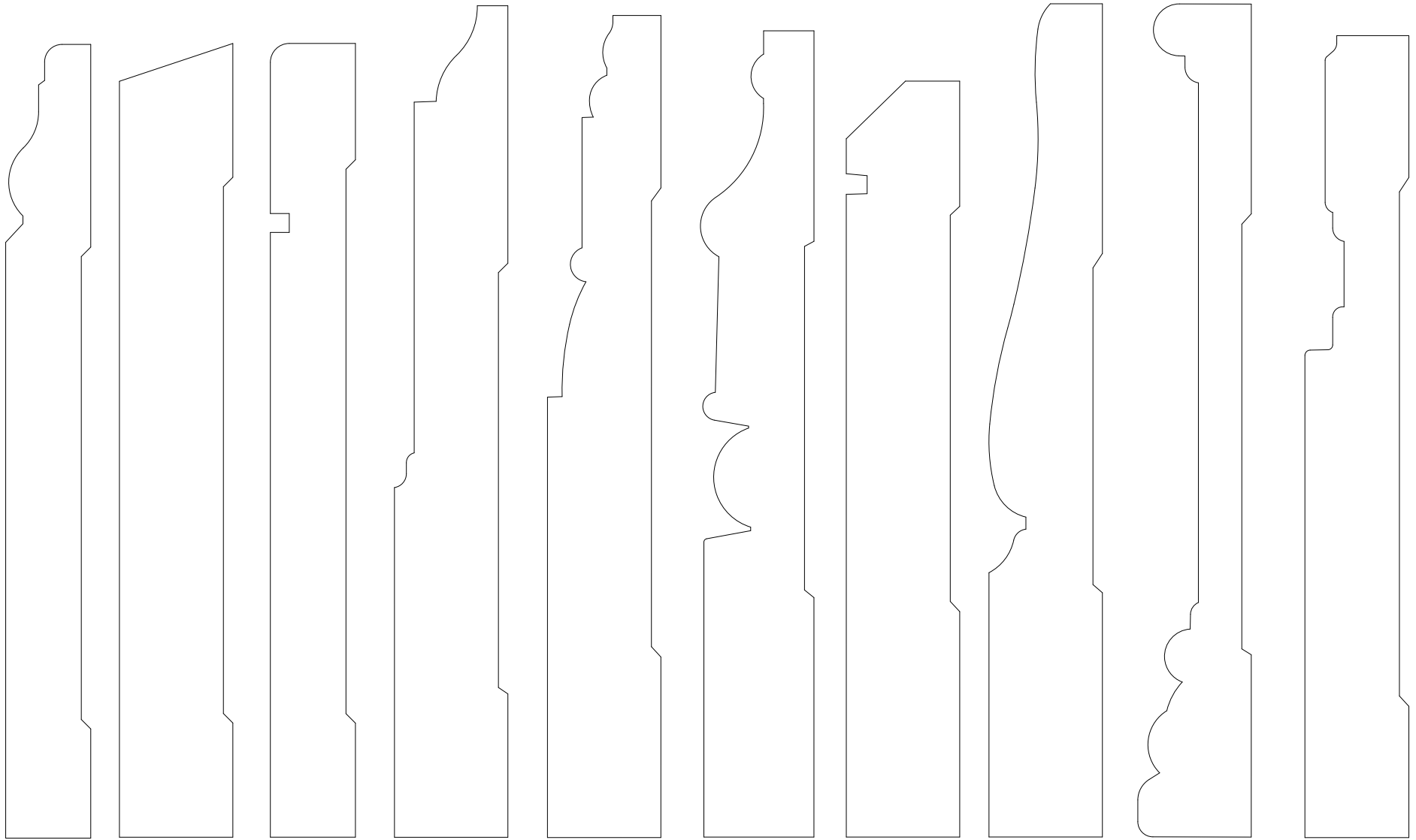

25101    25102    25103    25104    25105    25106    25107    25108    25109    25110

|  |   |
|--|---|
| EST. 1879<br><b>S T A R K</b><br>L U M B E R C O M P A N Y<br>FINE WOOD MOULDING | 924 W. 1st. Avenue<br>Denver, CO 80223<br>303-534-8263<br>Phone<br>303-534-8266 Fax |
|--|---|

|              |          |           |              |
|--------------|----------|-----------|--------------|
| Approved by: | MM/DD/YY |           |              |
| Drawn:       |          |           |              |
| File name:   |          |           |              |
|              |          | Scale 1:1 | Sheet 2-5-12 |

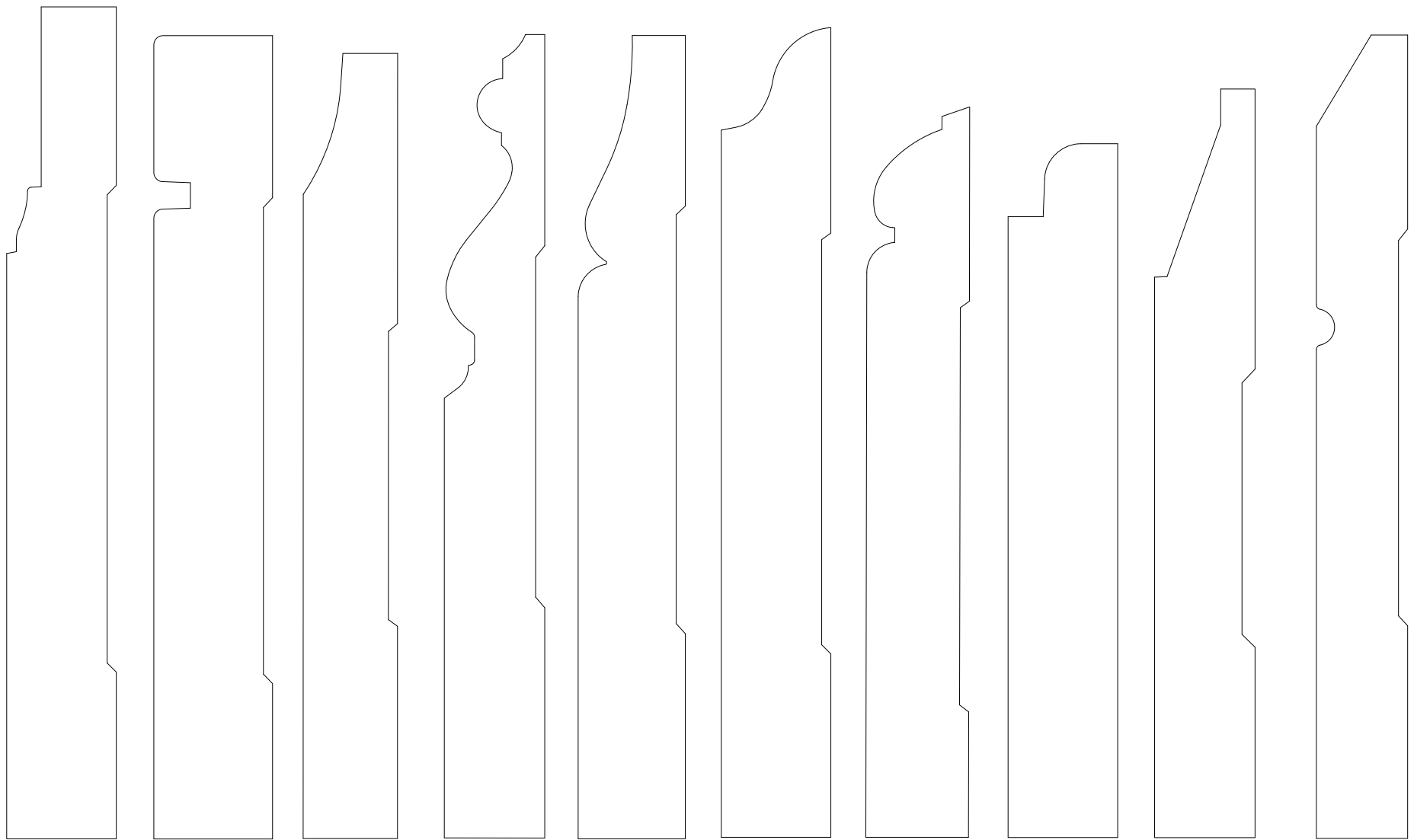

25111

25112

25113

25114

25115

25116

25117

25118

25119

25120

EST. 1879

**S T A R K**

L U M B E R C O M P A N Y

FINE WOOD MOULDING

924 W. 1st. Avenue  
 Denver, CO 80223  
 303-534-8263 Phone  
 303-534-8266 Fax

|              |          |              |
|--------------|----------|--------------|
| Approved by: | MM/DD/YY |              |
| Drawn:       |          |              |
| File name:   |          | Scale 1:1    |
|              |          | Sheet 2-5-13 |

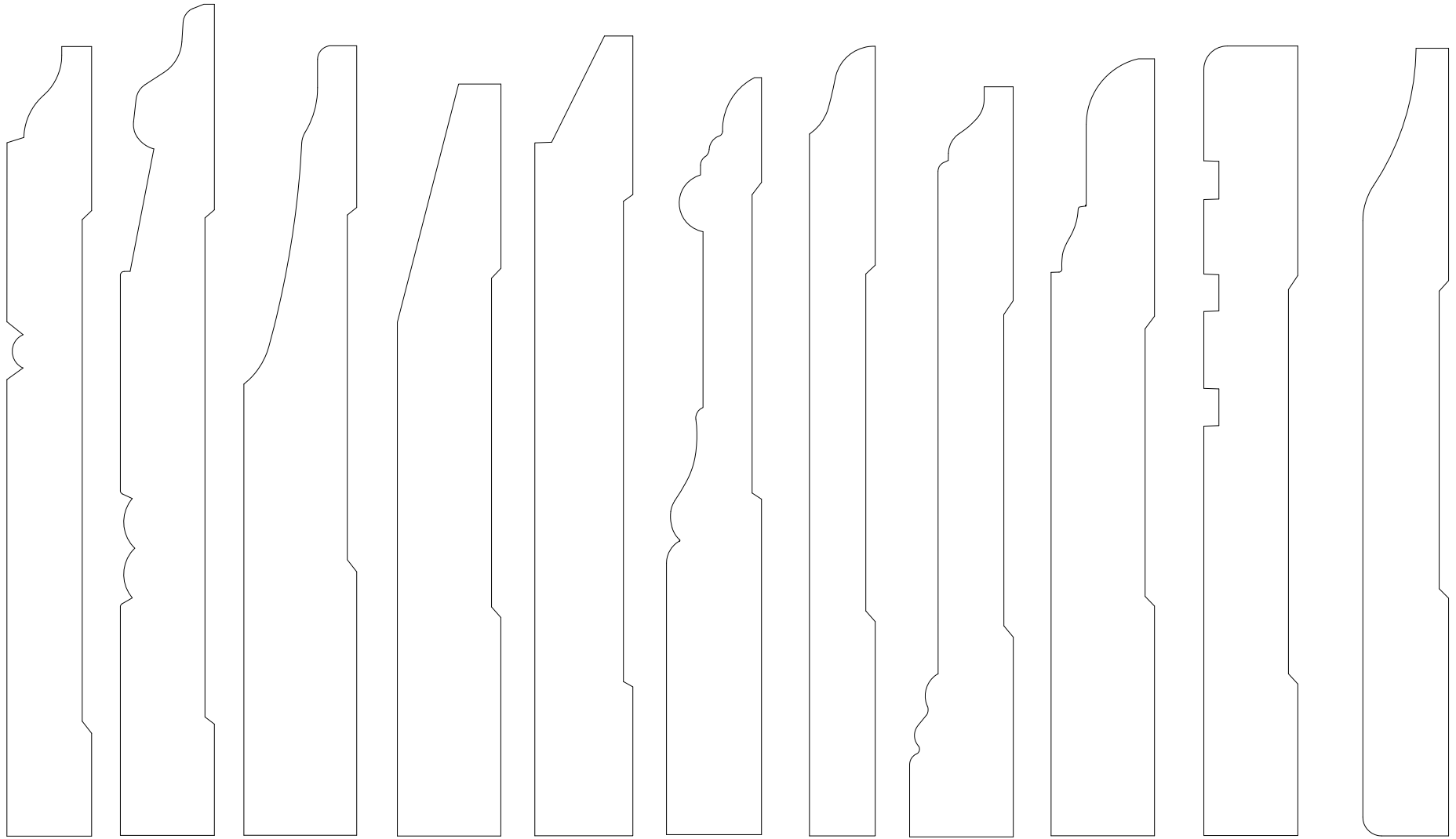

25121    25122    25123    25124    25125    25126    25127    25128    25129    25130    25131

EST. 1879  
**S T A R K**  
 L U M B E R C O M P A N Y  
 FINE WOOD MOULDING

924 W. 1st. Avenue  
 Denver, CO 80223  
 303-534-8263 Phone  
 303-534-8266 Fax

Approved by:    MM/DD/YY  
 Drawn:  
 File name:

Scale 1:1    Sheet 2-5-14

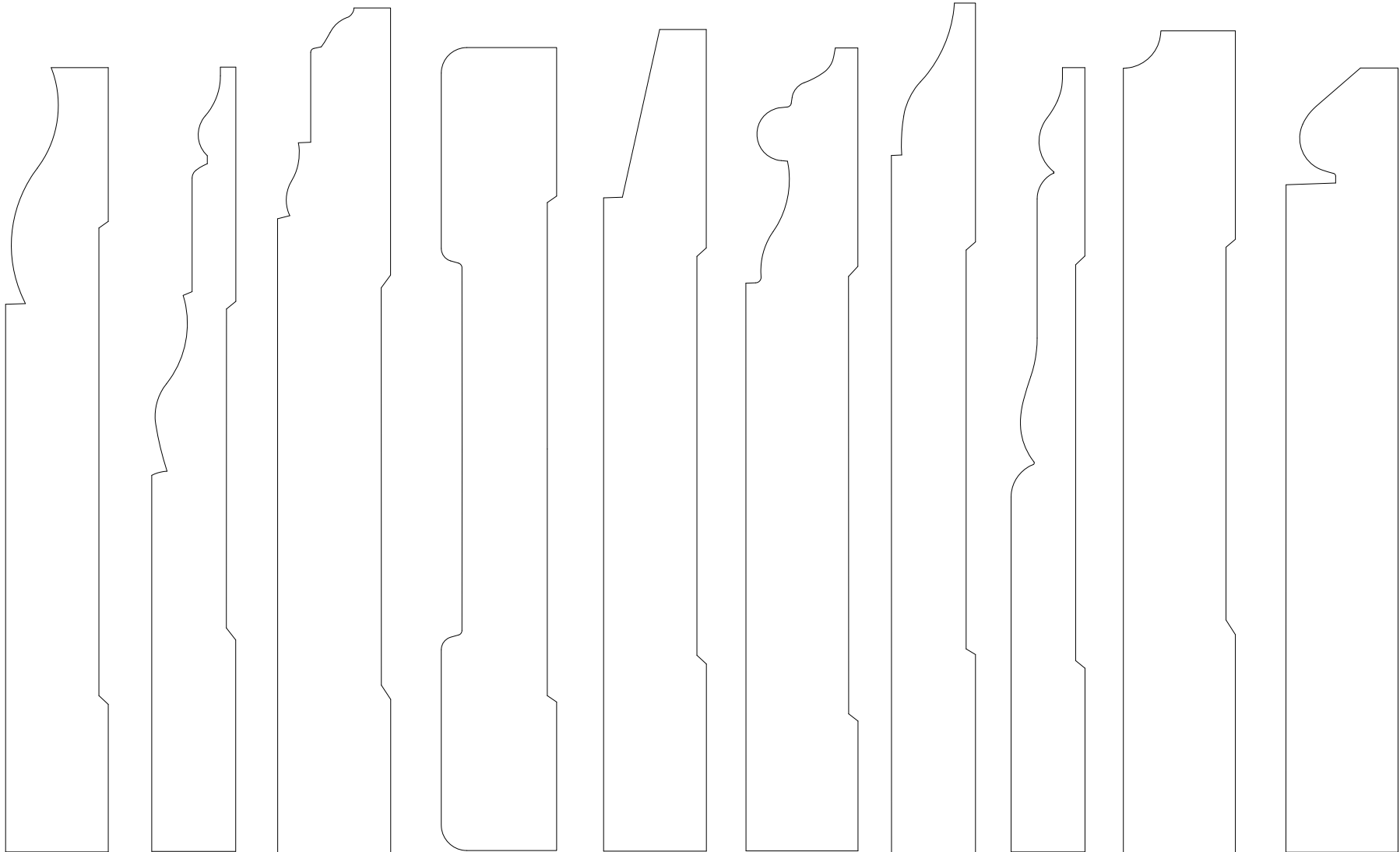

25132

25133

25134

25135

25136

25137

25138

25139

25140

25141

EST. 1879

**S T A R K**

L U M B E R C O M P A N Y

FINE WOOD MOULDING

924 W. 1st. Avenue  
 Denver, CO 80223  
 303-534-8263 Phone  
 303-534-8266 Fax

|              |          |              |
|--------------|----------|--------------|
| Approved by: | MM/DD/YY |              |
| Drawn:       |          |              |
| File name:   |          | Scale 1:1    |
|              |          | Sheet 2-5-15 |

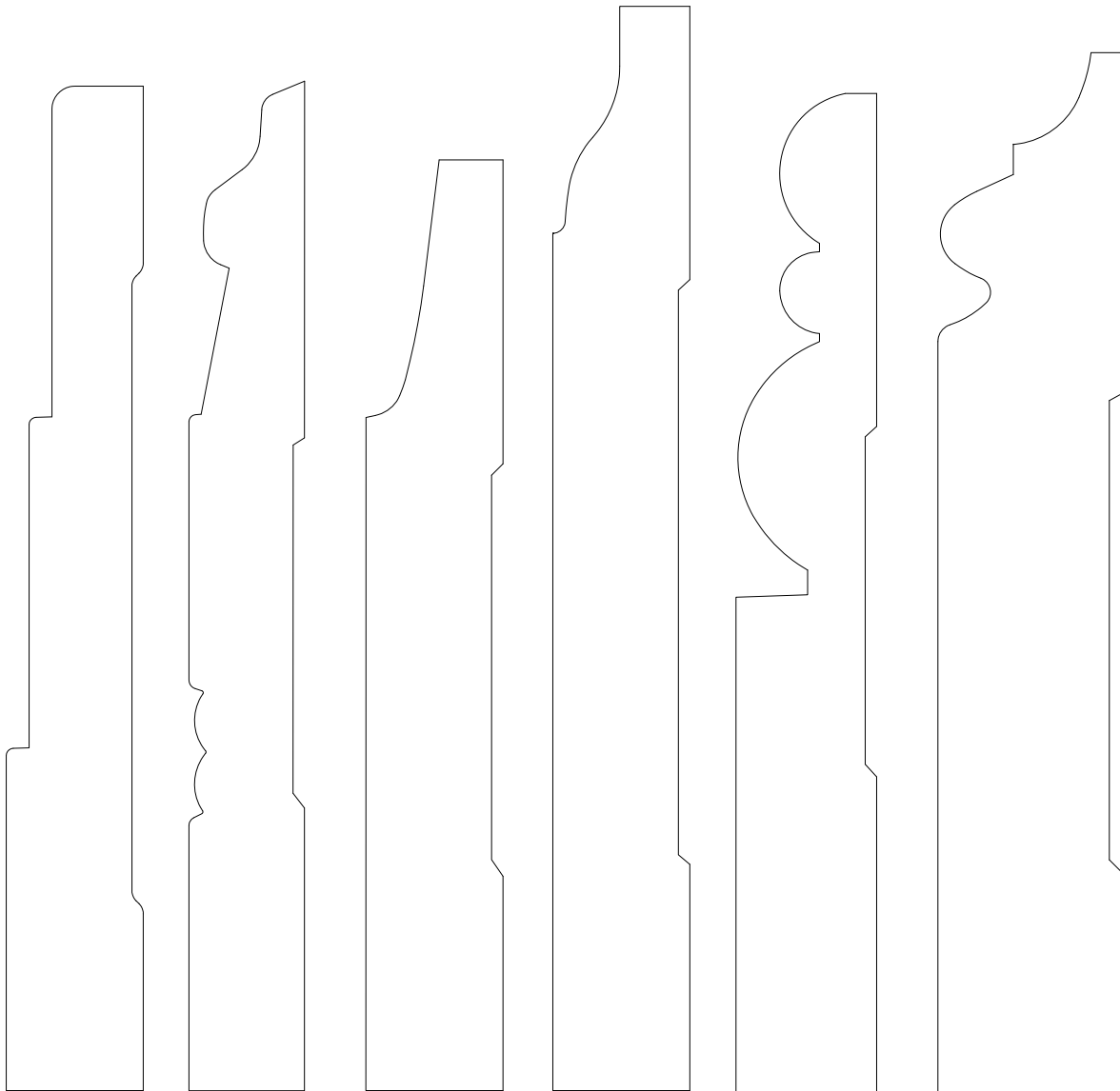

25142

25143

25144

25145

25146

25147

EST. 1879

**S T A R K**

L U M B E R C O M P A N Y

FINE WOOD MOULDING

924 W. 1st. Avenue  
 Denver, CO 80223  
 303-534-8263 Phone  
 303-534-8266 Fax

|              |          |                        |
|--------------|----------|------------------------|
| Approved by: | MM/DD/YY |                        |
| Drawn:       |          |                        |
| File name:   |          | Scale 1:1 Sheet 2-5-16 |



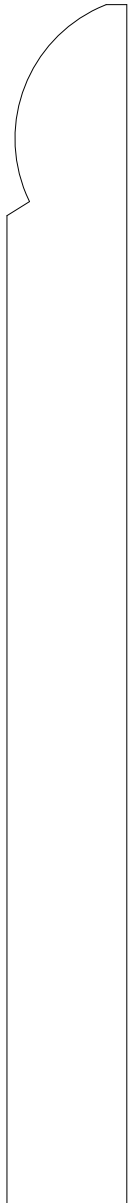

26001

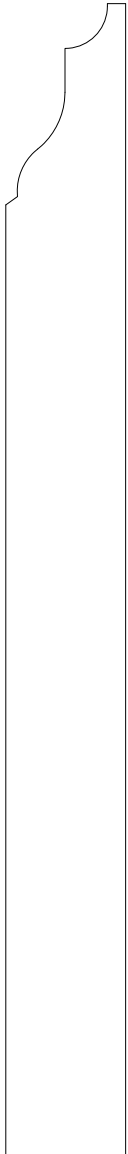

26002

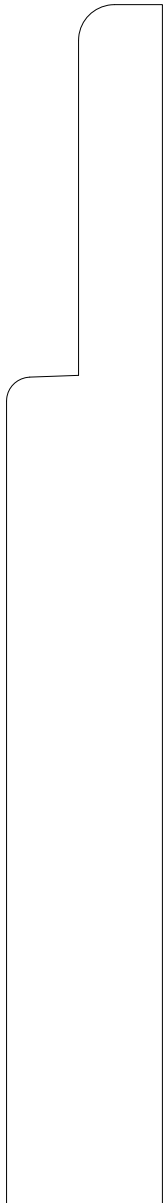

26003

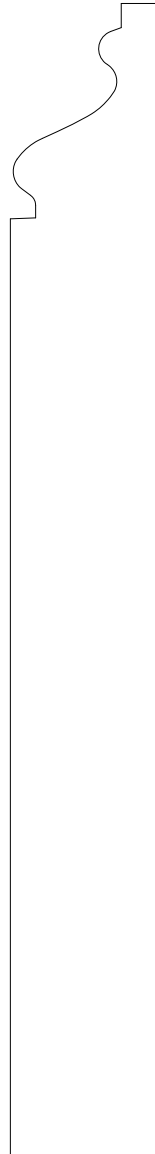

26004



26005

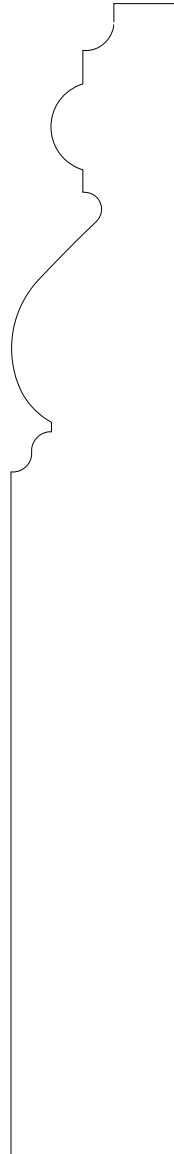

26006

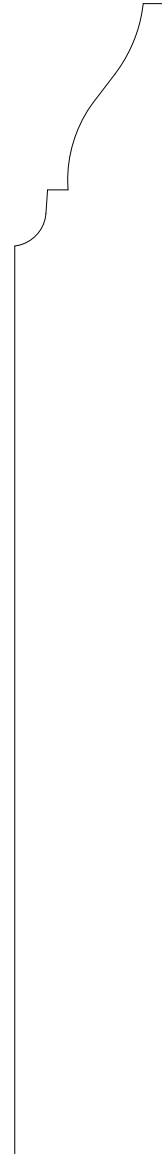

26007



26008

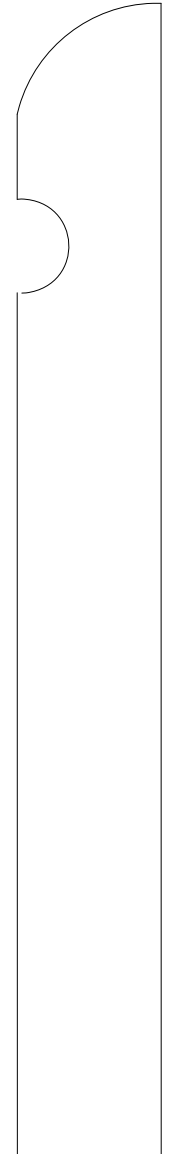

26009

EST. 1879

**S T A R K**

L U M B E R C O M P A N Y

FINE WOOD MOULDING

924 W. 1st. Avenue  
 Denver, CO 80223  
 303-534-8263 Phone  
 303-534-8266 Fax

|              |          |             |
|--------------|----------|-------------|
| Approved by: | MM/DD/YY |             |
| Drawn:       |          |             |
| File name:   |          | Scale 1:1   |
|              |          | Sheet 2-6-1 |

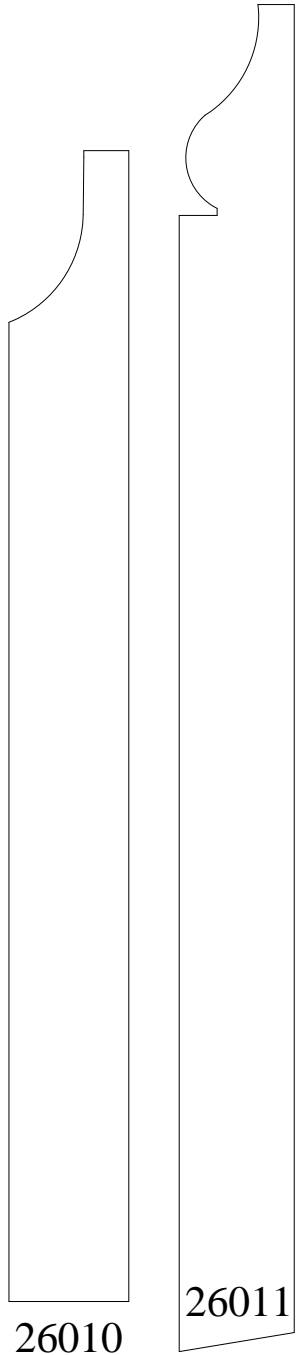

26010

26011

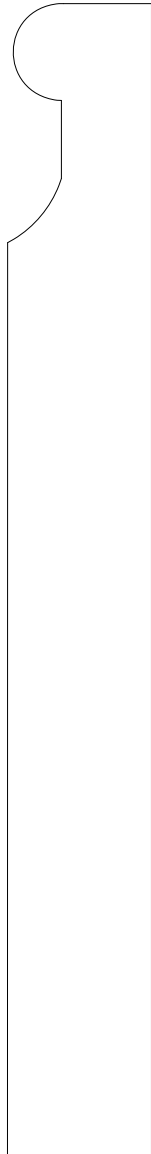

26012

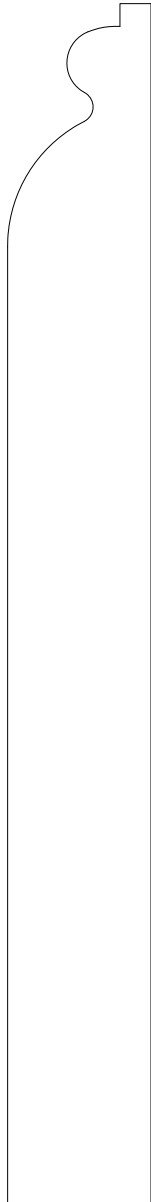

26013

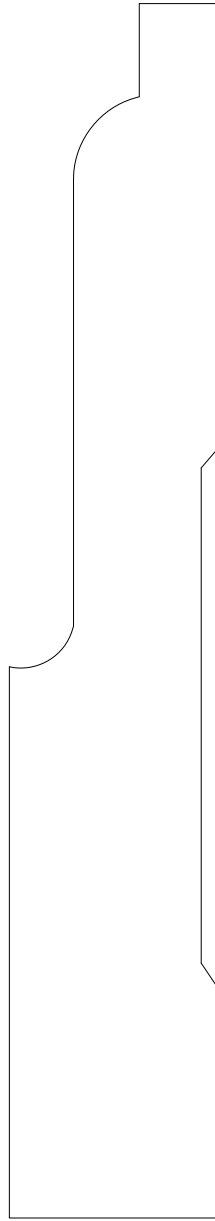

26014

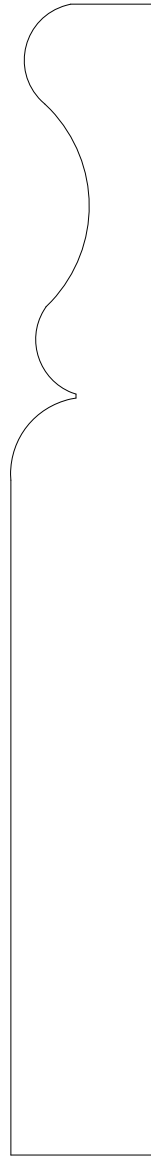

26015

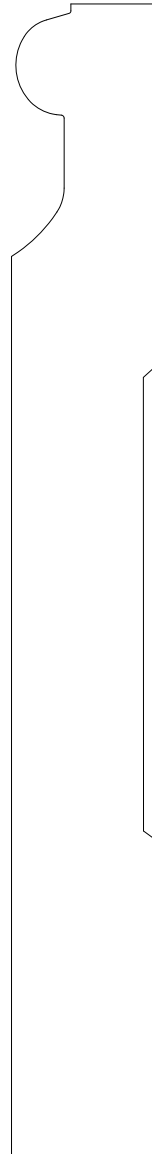

26016

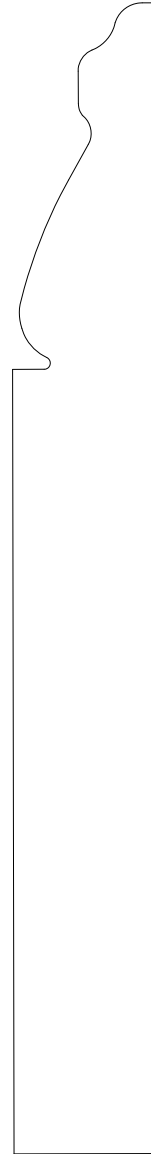

26017

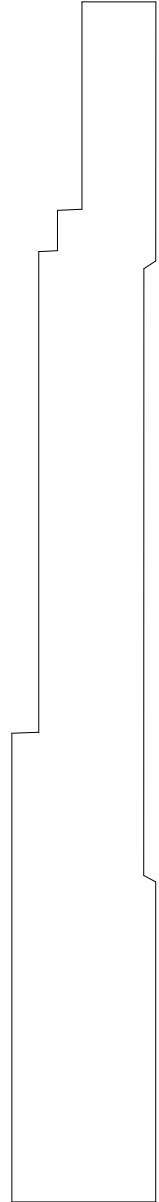

26018

EST. 1879

**S T A R K**

L U M B E R C O M P A N Y

FINE WOOD MOULDING

924 W. 1st. Avenue  
 Denver, CO 80223  
 303-534-8263 Phone  
 303-534-8266 Fax

|              |          |
|--------------|----------|
| Approved by: | MM/DD/YY |
| Drawn:       |          |
| File name:   |          |

Scale 1:1

Sheet 2-6-2

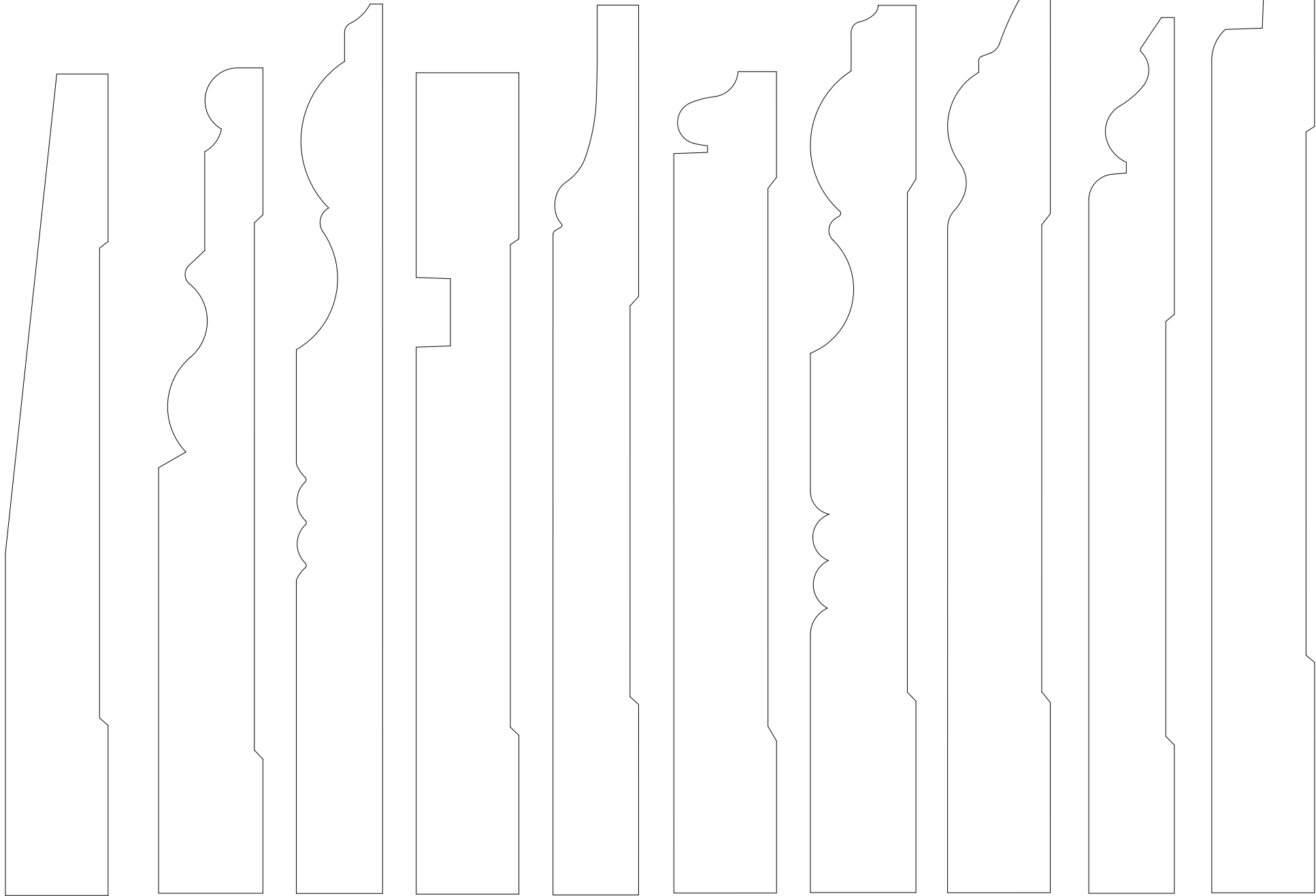

26019

26020

26021

26022

26023

26024

26025

26026

26027

26028

|   |  |
|---|--|
| <p>EST. 1879</p> <p><b>S T A R K</b></p> <p>L U M B E R C O M P A N Y</p> <p>FINE WOOD MOULDING</p> | <p>924 W. 1st. Avenue<br/>           Denver, CO 80223<br/>           303-534-8263<br/>           Phone<br/>           303-534-8266 Fax</p> |
|---|--|

|              |          |             |
|--------------|----------|-------------|
| Approved by: | MM/DD/YY |             |
| Drawn:       |          |             |
| File name:   |          | Scale 1:1   |
|              |          | Sheet 2-6-3 |

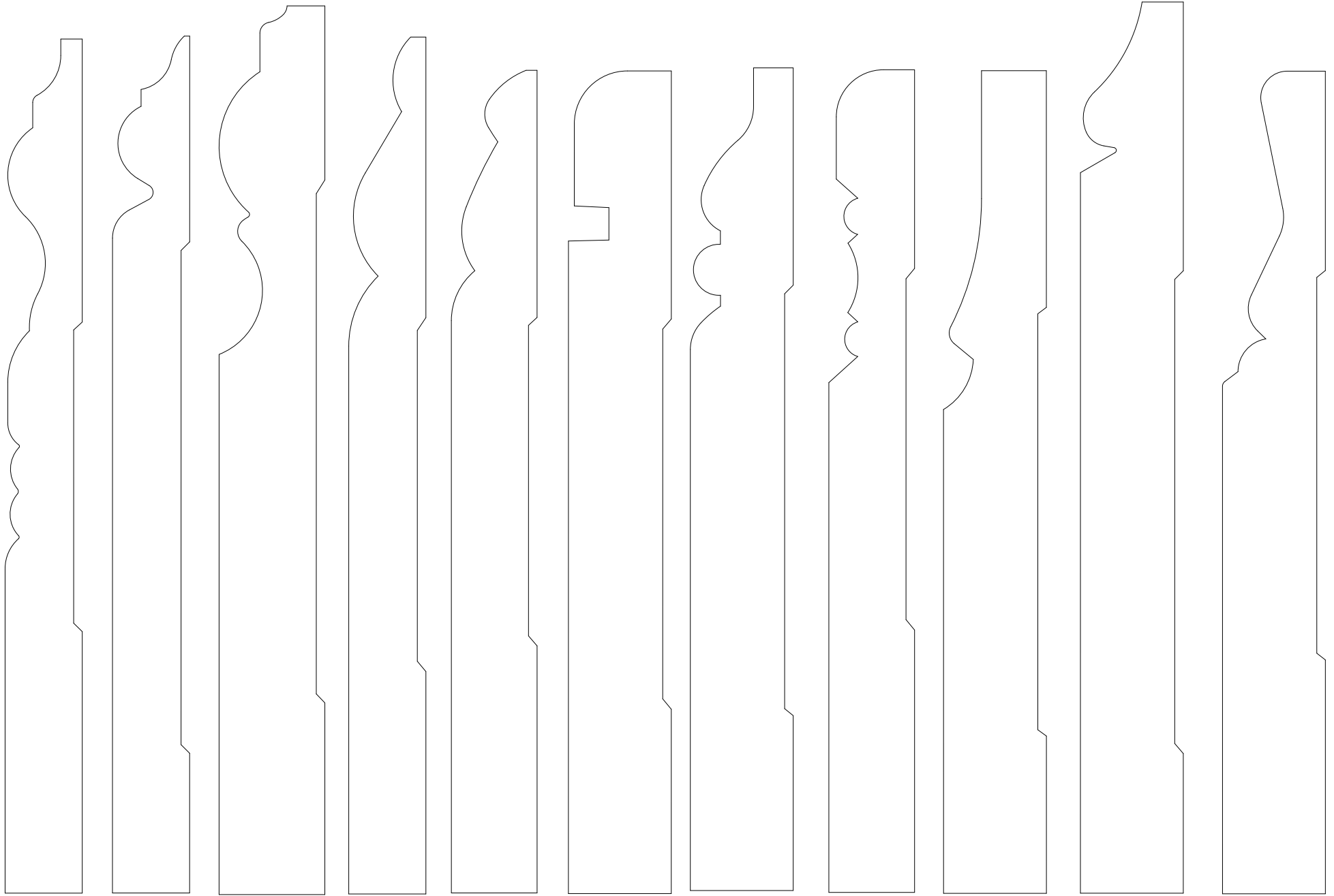

26029 26030 26031 26032 26033 26034 26035 26036 26037 26038 26039

|  |  |
|--|--|
|  | EST. 1879<br>924 W. 1st. Avenue<br>Denver, CO 80223<br>303-534-8263<br>Phone |
|  | 303-534-8266 Fax   |

|              |          |                       |
|--------------|----------|-----------------------|
| Approved by: | MM/DD/YY |                       |
| Drawn:       |          |                       |
| File name:   |          | Scale 1:1 Sheet 2-6-4 |

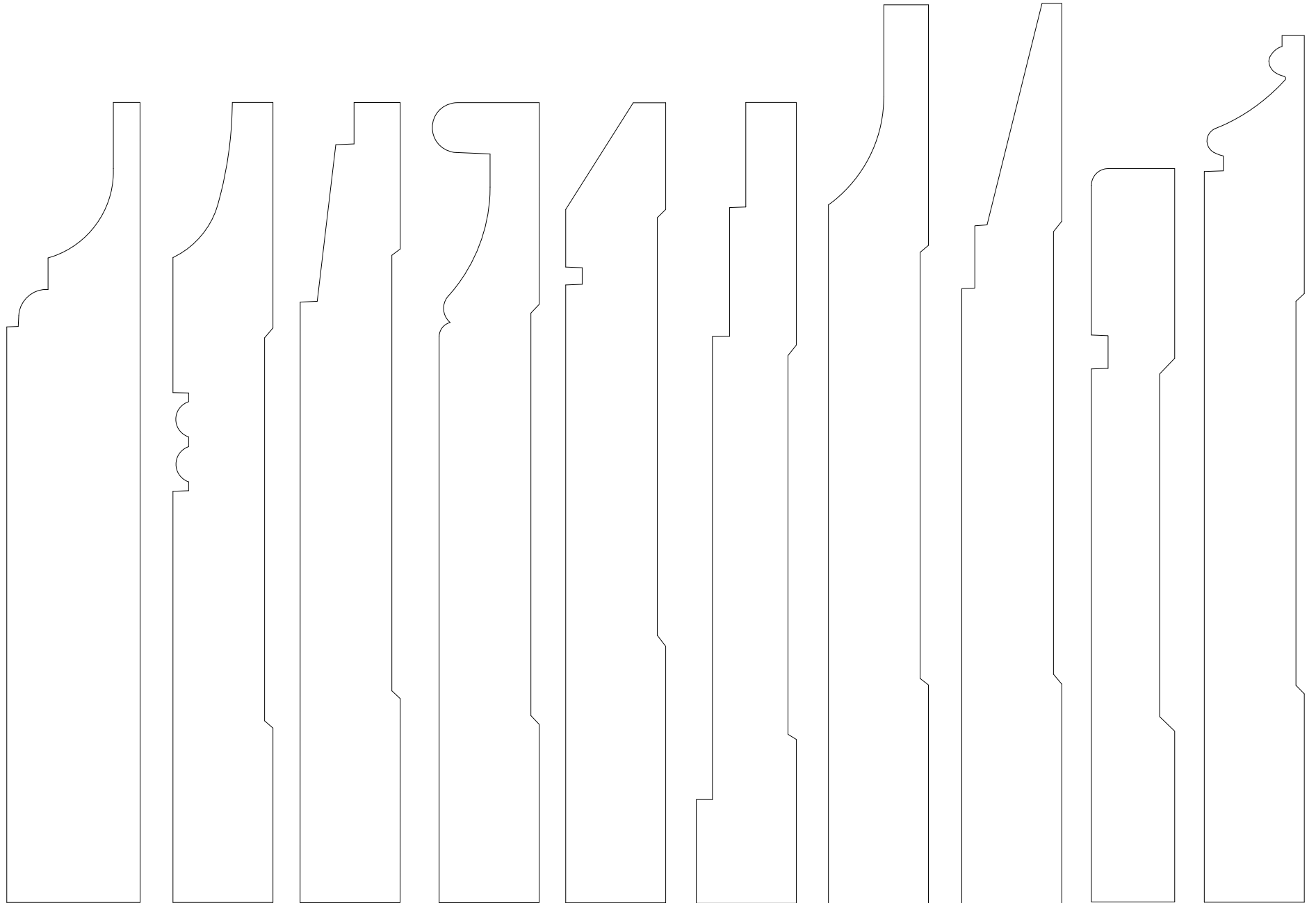

26040

26041

26042

26043

26044

26045

26046

26047

26048

26049

EST. 1879

**S T A R K**

L U M B E R C O M P A N Y

FINE WOOD MOULDING

924 W. 1st. Avenue  
 Denver, CO 80223  
 303-534-8263 Phone  
 303-534-8266 Fax

|              |          |                       |
|--------------|----------|-----------------------|
| Approved by: | MM/DD/YY |                       |
| Drawn:       |          |                       |
| File name:   |          | Scale 1:1 Sheet 2-6-5 |

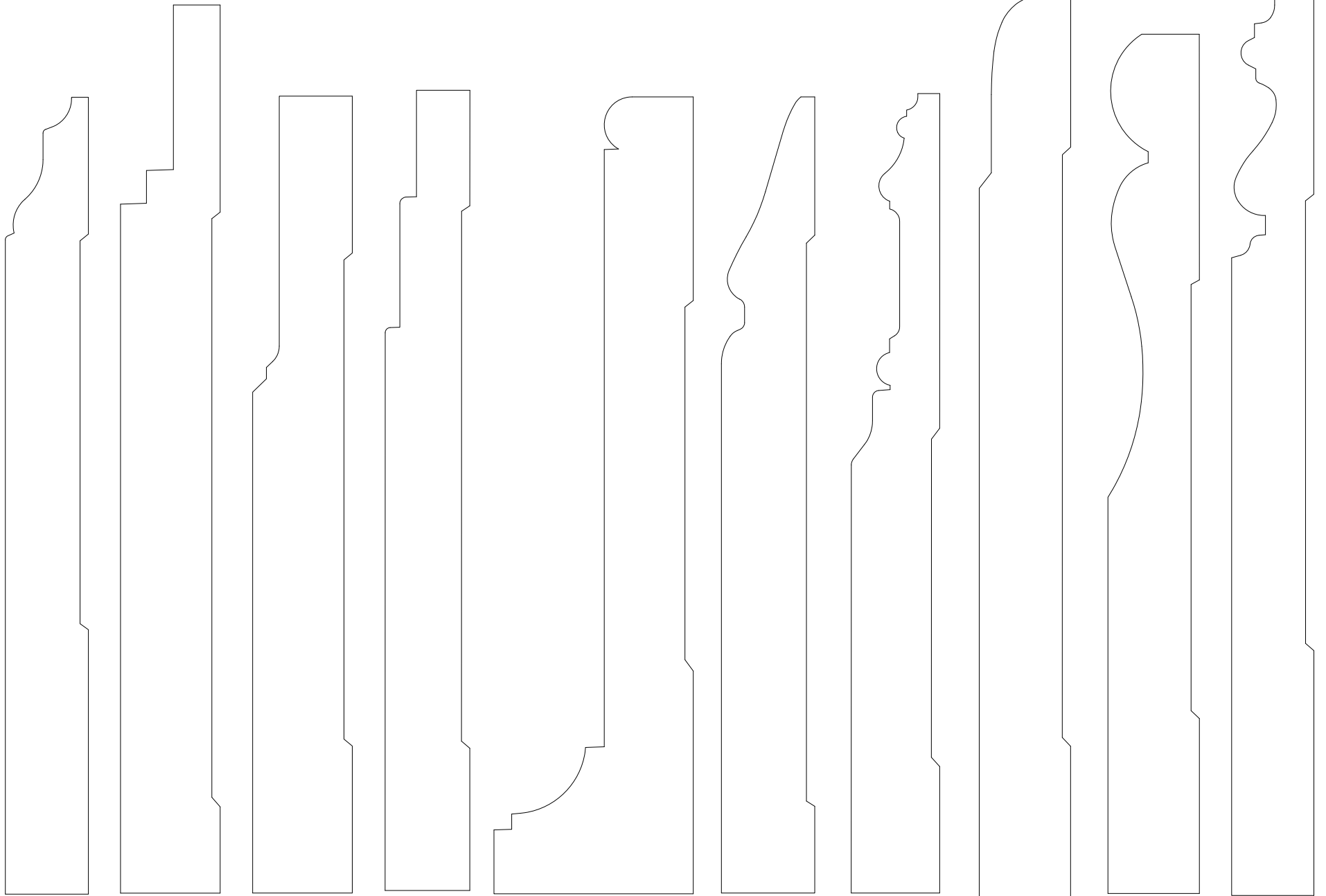

26050    26051    26052    26053    26054    26055    26056    26057    26058    26059

EST. 1879  
**S T A R K**  
 L U M B E R C O M P A N Y  
 FINE WOOD MOULDING

924 W. 1st. Avenue  
 Denver, CO 80223  
 303-534-8263 Phone  
 303-534-8266 Fax

|              |          |
|--------------|----------|
| Approved by: | MM/DD/YY |
| Drawn:       |          |
| File name:   |          |

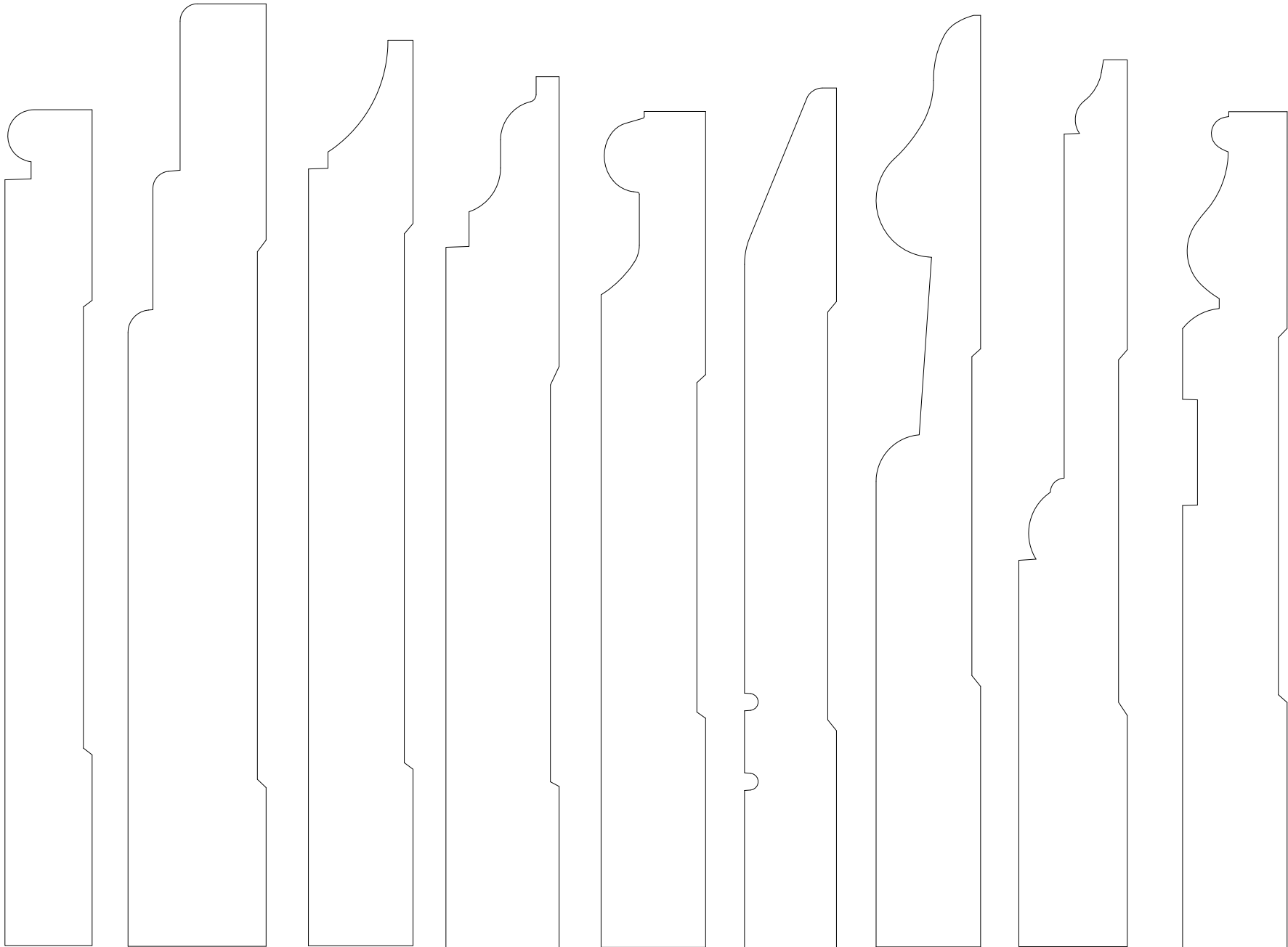

26060

26061

26062

26063

26064

26065

26066

26067

26068

EST. 1879

**S T A R K**

L U M B E R C O M P A N Y

FINE WOOD MOULDING

924 W. 1st. Avenue  
 Denver, CO 80223  
 303-534-8263 Phone  
 303-534-8266 Fax

|              |          |                       |
|--------------|----------|-----------------------|
| Approved by: | MM/DD/YY |                       |
| Drawn:       |          |                       |
| File name:   |          | Scale 1:1 Sheet 2-6-7 |



27001



27002

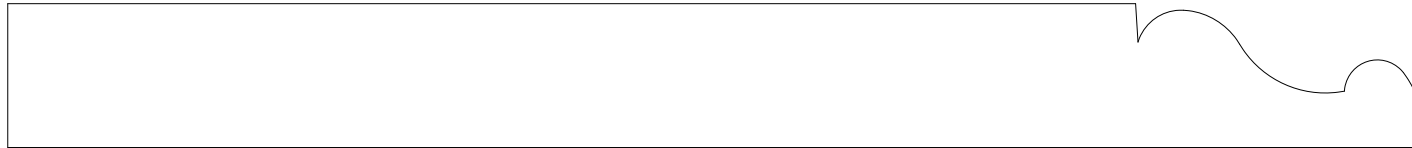

27003



27004



27005

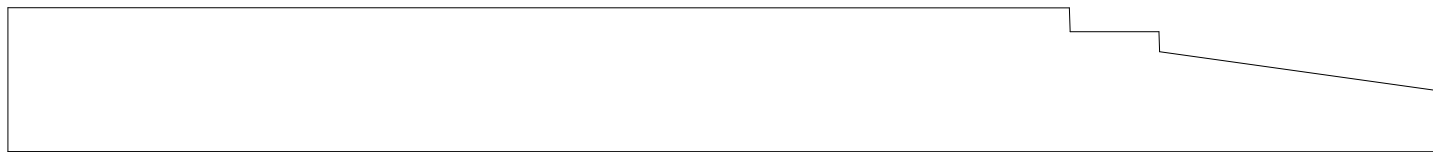

27006

|   |   |
|---|---|
| <br><b>S T A R K</b><br>L U M B E R C O M P A N Y<br>FINE WOOD MOULDING | EST. 1879<br>924 W. 1st. Avenue<br>Denver, CO 80223<br>303-534-8263 Phone<br>303-534-8266 Fax |
|   | (Empty space)   |

|              |          |
|--------------|----------|
| Approved by: | MM/DD/YY |
| Drawn:       |          |
| File name:   |          |

|           |             |
|-----------|-------------|
| Scale 1:1 | Sheet 2-7-1 |
|-----------|-------------|



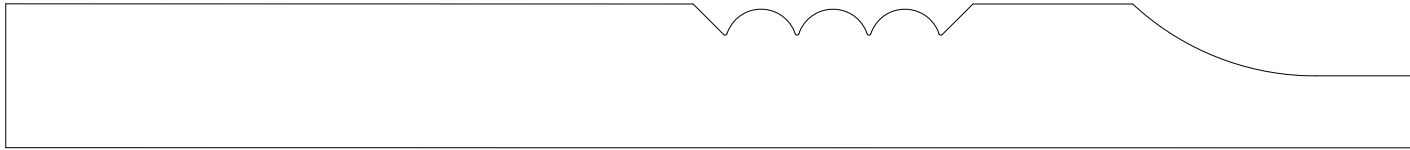

27007



27008

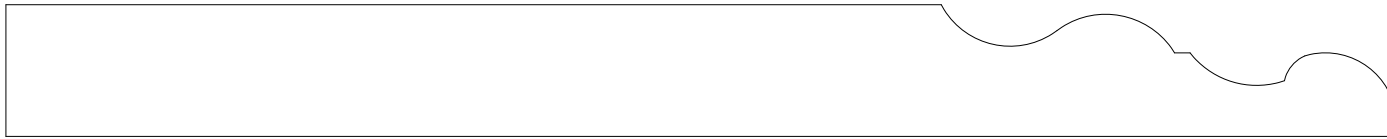

27009



27010



27011



27012

EST. 1879

**S T A R K**

L U M B E R C O M P A N Y

FINE WOOD MOULDING

924 W. 1st. Avenue  
 Denver, CO 80223  
 303-534-8263 Phone  
 303-534-8266 Fax

|              |          |             |
|--------------|----------|-------------|
| Approved by: | MM/DD/YY |             |
| Drawn:       |          |             |
| File name:   |          | Scale 1:1   |
|              |          | Sheet 2-7-2 |

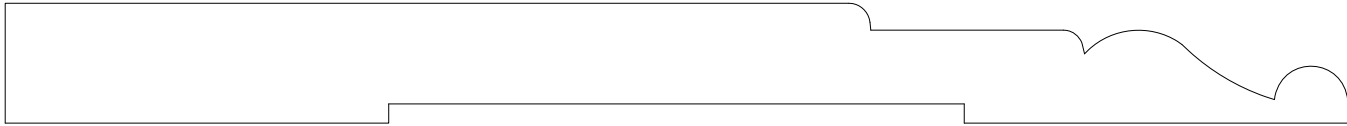

27013

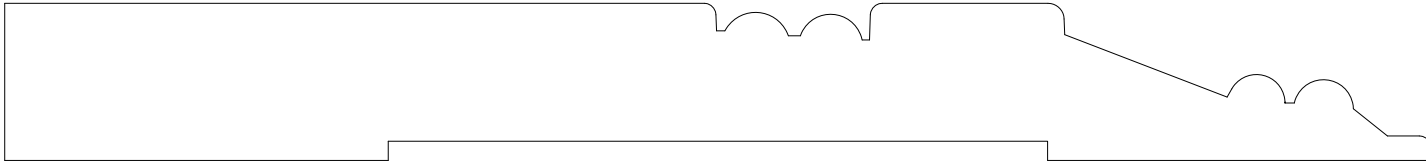

27014

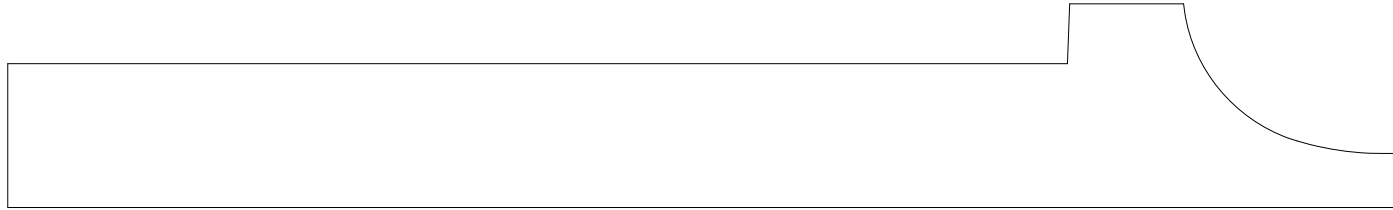

27015

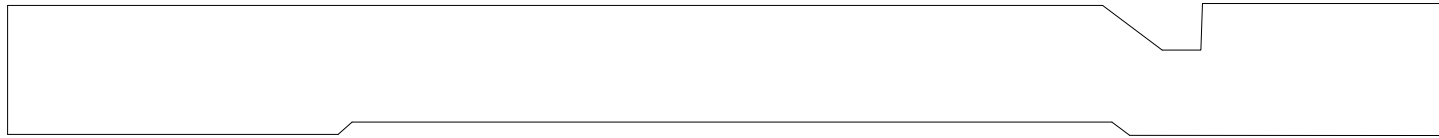

27016



27017



27018

EST. 1879

**S T A R K**

L U M B E R C O M P A N Y

FINE WOOD MOULDING

924 W. 1st. Avenue  
 Denver, CO 80223  
 303-534-8263 Phone  
 303-534-8266 Fax

|              |          |             |
|--------------|----------|-------------|
| Approved by: | MM/DD/YY |             |
| Drawn:       |          |             |
| File name:   |          | Scale 1:1   |
|              |          | Sheet 2-7-3 |

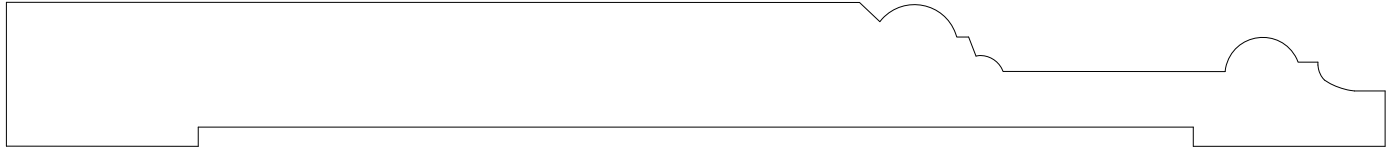

27019



27020

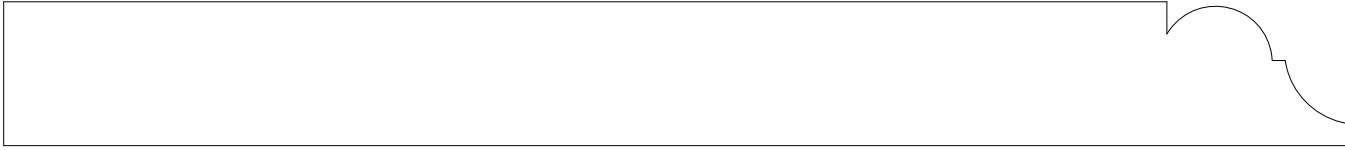

27021

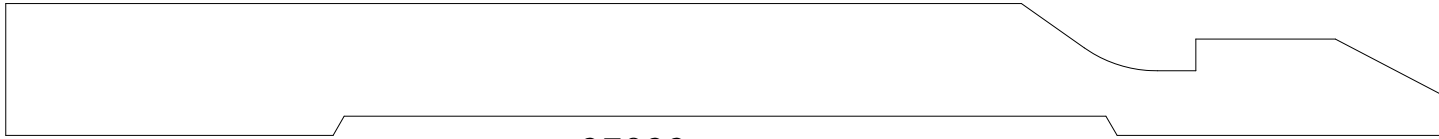

27022



27023

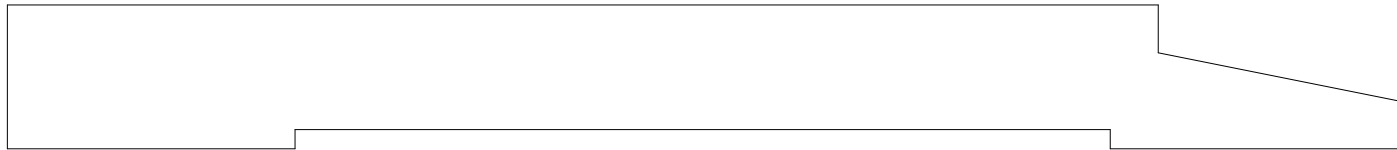

27024

EST. 1879

**S T A R K**

L U M B E R C O M P A N Y

FINE WOOD MOULDING

924 W. 1st. Avenue  
 Denver, CO 80223  
 303-534-8263 Phone  
 303-534-8266 Fax

|  |
|--|
|  |
|--|

|              |          |
|--------------|----------|
| Approved by: | MM/DD/YY |
| Drawn:       |          |
| File name:   |          |

|           |             |
|-----------|-------------|
| Scale 1:1 | Sheet 2-7-4 |
|-----------|-------------|

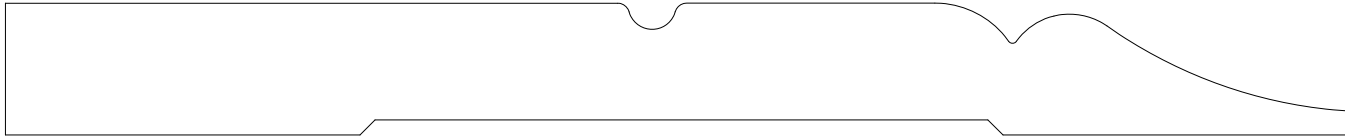

27025



27026

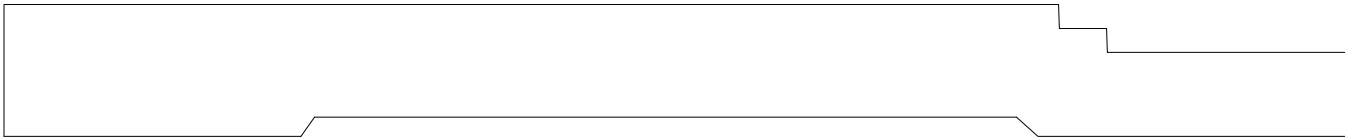

27027



27028

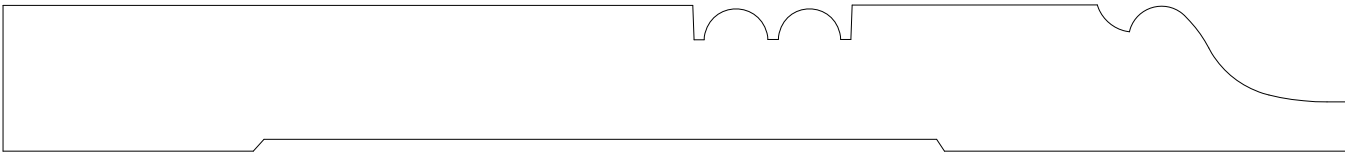

27029

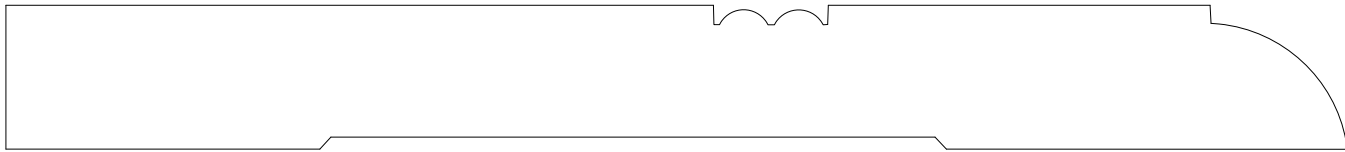

27030

EST. 1879

**S T A R K**

L U M B E R C O M P A N Y

FINE WOOD MOULDING

924 W. 1st. Avenue  
 Denver, CO 80223  
 303-534-8263 Phone  
 303-534-8266 Fax

|  |
|--|
|  |
|--|

|              |          |
|--------------|----------|
| Approved by: | MM/DD/YY |
| Drawn:       |          |
| File name:   |          |

|           |            |
|-----------|------------|
| Scale 1:1 | Sheet2-7-5 |
|-----------|------------|

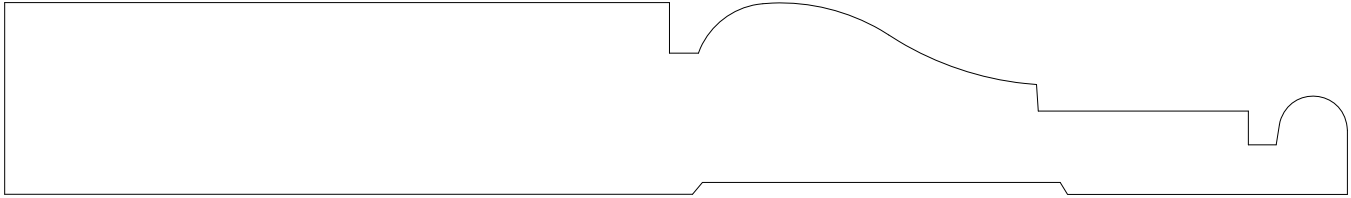

27031



27032



27033

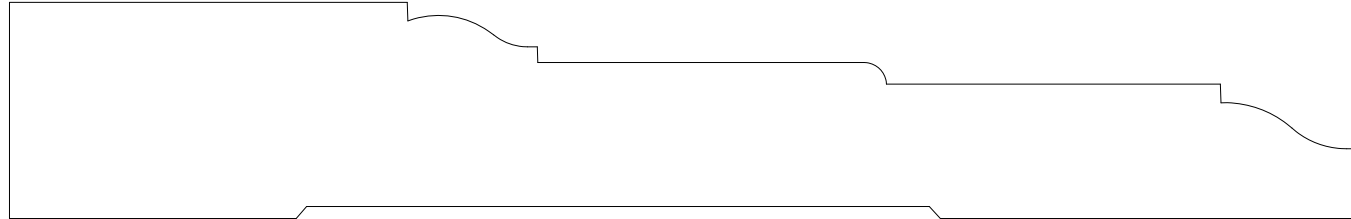

27034



27035

EST. 1879

**S T A R K**

L U M B E R C O M P A N Y

FINE WOOD MOULDING

924 W. 1st. Avenue  
 Denver, CO 80223  
 303-534-8263 Phone  
 303-534-8266 Fax

|              |          |           |             |
|--------------|----------|-----------|-------------|
| Approved by: | MM/DD/YY |           |             |
| Drawn:       |          |           |             |
| File name:   |          | Scale 1:1 | Sheet 2-7-6 |

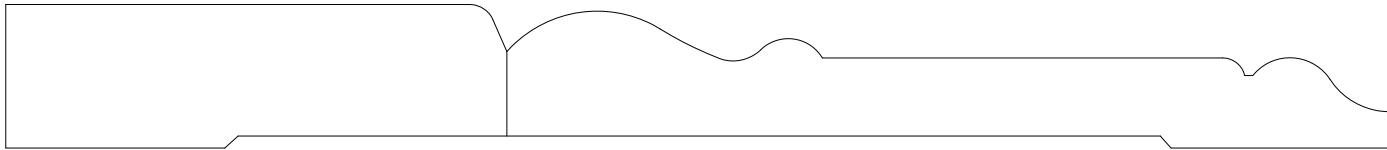

27036

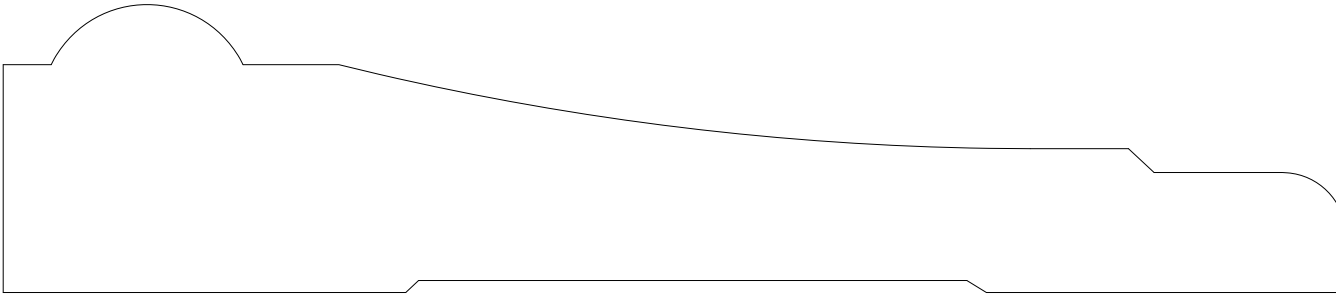

27037



27038



27039

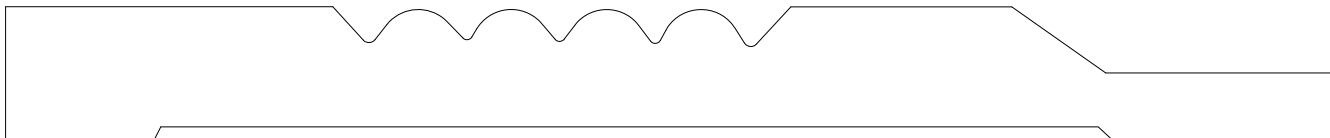

27040

EST. 1879

**S T A R K**

L U M B E R C O M P A N Y

FINE WOOD MOULDING

924 W. 1st. Avenue  
 Denver, CO 80223  
 303-534-8263 Phone  
 303-534-8266 Fax

|              |          |           |             |
|--------------|----------|-----------|-------------|
| Approved by: | MM/DD/YY |           |             |
| Drawn:       |          |           |             |
| File name:   |          | Scale 1:1 | Sheet 2-7-7 |



27041



27042



27043



27044



27045



27046

|  |   |
|--|---|
|  <p>EST. 1879<br/><b>S T A R K</b><br/>LUMBER COMPANY<br/>FINE WOOD MOULDING</p> | 924 W. 1st. Avenue<br>Denver, CO 80223<br>303-534-8263<br>Phone |
|  | 303-534-8266 Fax  |

|  |
|--|
|  |
|--|

|              |          |
|--------------|----------|
| Approved by: | MM/DD/YY |
| Drawn:       |          |
| File name:   |          |

|           |             |
|-----------|-------------|
| Scale 1:1 | Sheet 2-7-8 |
|-----------|-------------|

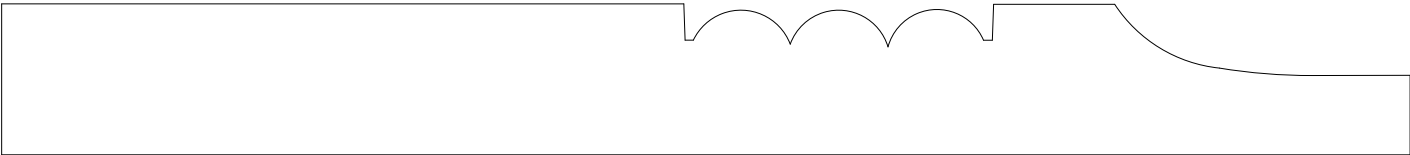

27047



27048

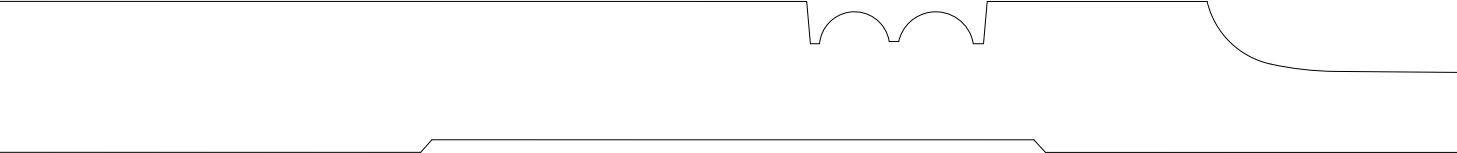

27049



27050



27051



27052

|  |   |
|--|---|
|  <p>EST. 1879<br/><b>S T A R K</b><br/>LUMBER COMPANY<br/>FINE WOOD MOULDING</p> | 924 W. 1st. Avenue<br>Denver, CO 80223<br>303-534-8263<br>Phone |
|  | 303-534-8266 Fax  |

|  |
|--|
|  |
|--|

|              |          |
|--------------|----------|
| Approved by: | MM/DD/YY |
| Drawn:       |          |
| File name:   |          |

|           |             |
|-----------|-------------|
| Scale 1:1 | Sheet 2-7-9 |
|-----------|-------------|





27053



27054

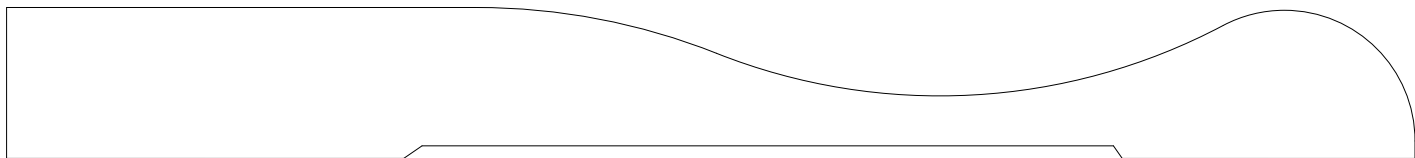

27055



27056

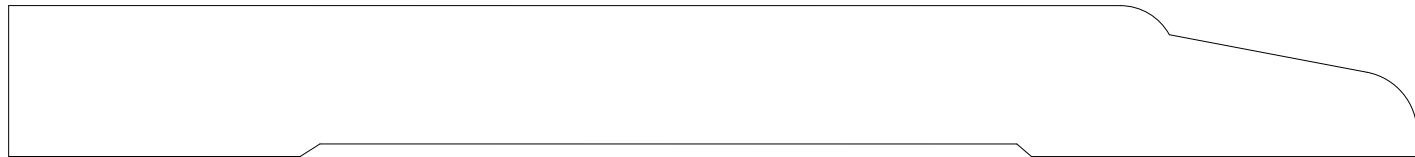

27057

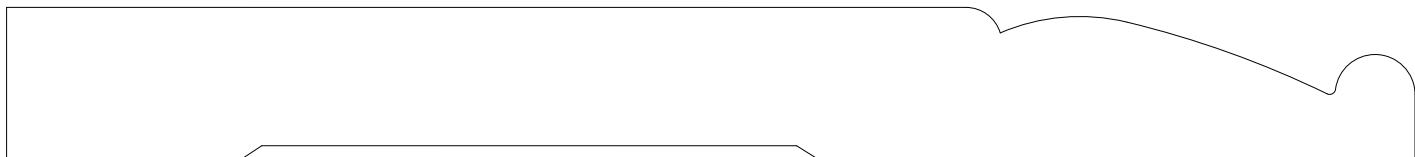

27058

|  |   |
|--|---|
|  | 924 W. 1st. Avenue<br>Denver, CO 80223<br>303-534-8263<br>Phone |
|  | 303-534-8266 Fax  |

|  |
|--|
|  |
|--|

|              |          |
|--------------|----------|
| Approved by: | MM/DD/YY |
| Drawn:       |          |
| File name:   |          |

|           |              |
|-----------|--------------|
| Scale 1:1 | Sheet 2-7-10 |
|-----------|--------------|



27059



27060



27061



27062



27063



924 W. 1st. Avenue  
Denver, CO 80223  
303-534-8263 Phone  
303-534-8266 Fax

Approved by:

MM/DD/YY

Drawn:

File name:

Scale 1:1

Sheet 2-7-11

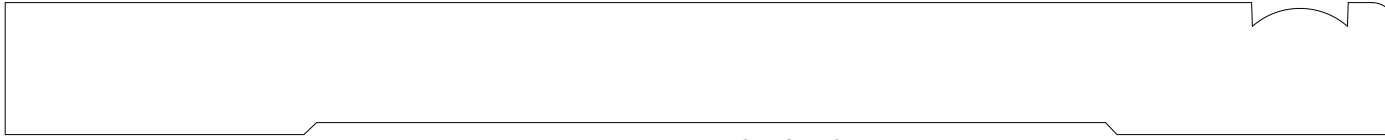

27064



27065

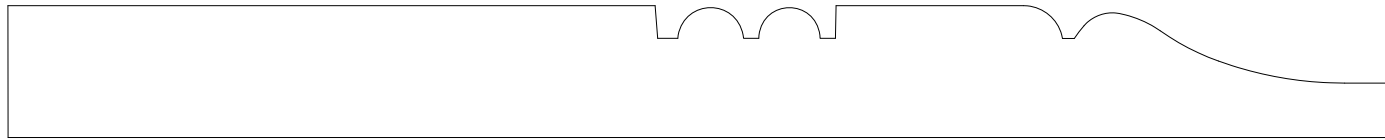

27066



27067



27068



27069

EST. 1879

**S T A R K**

L U M B E R C O M P A N Y

FINE WOOD MOULDING

924 W. 1st. Avenue  
 Denver, CO 80223  
 303-534-8263 Phone  
 303-534-8266 Fax

|              |          |           |              |
|--------------|----------|-----------|--------------|
| Approved by: | MM/DD/YY |           |              |
| Drawn:       |          |           |              |
| File name:   |          | Scale 1:1 | Sheet 2-7-12 |

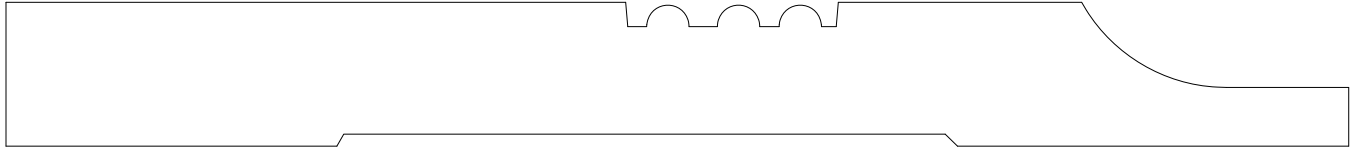

27070

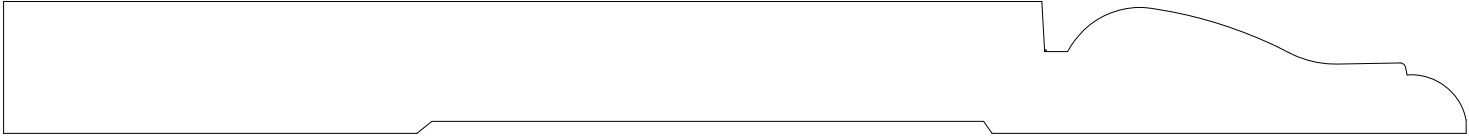

27071



27072

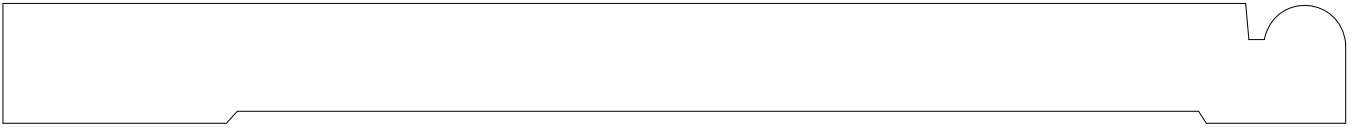

27073

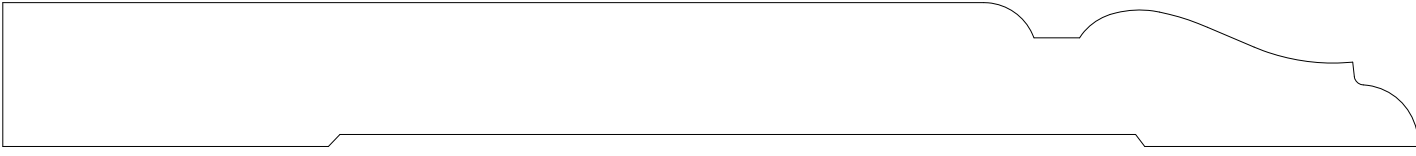

27074

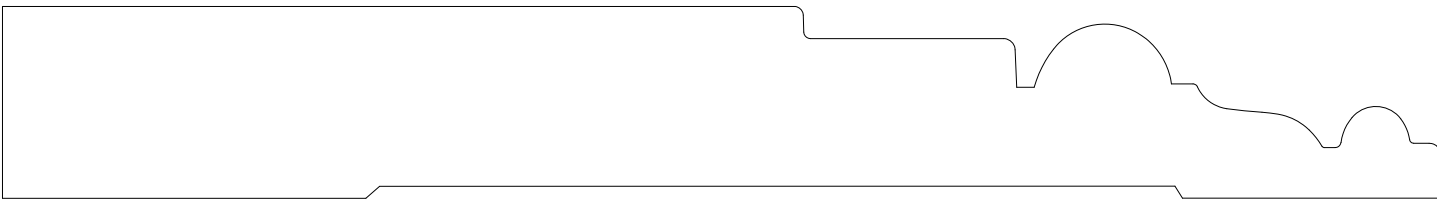

27075



924 W. 1st. Avenue  
Denver, CO 80223  
303-534-8263 Phone  
303-534-8266 Fax



|              |          |
|--------------|----------|
| Approved by: | MM/DD/YY |
| Drawn:       |          |
| File name:   |          |

|           |              |
|-----------|--------------|
| Scale 1:1 | Sheet 2-7-13 |
|-----------|--------------|

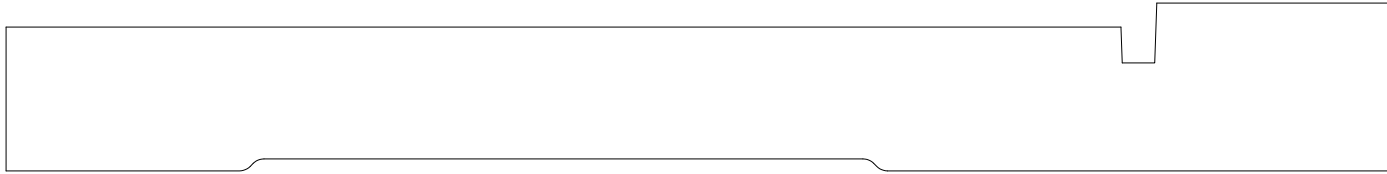

27076

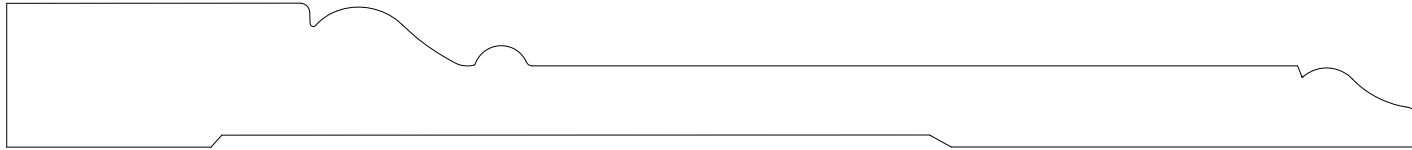

27077

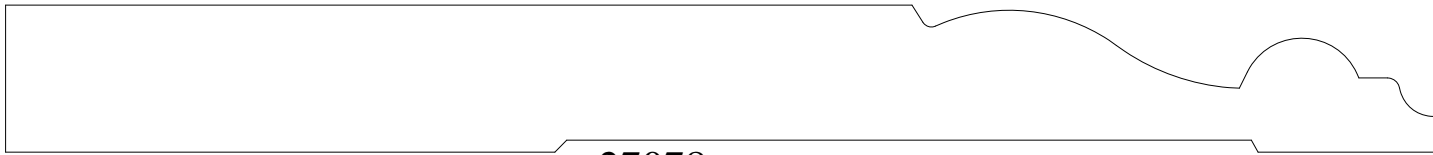

27078

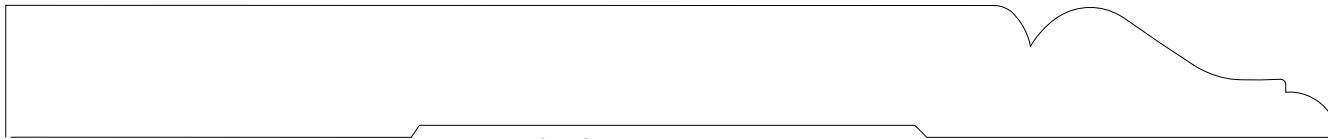

27079

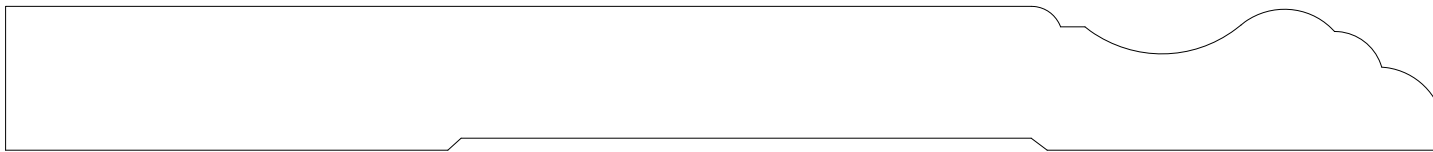

27080

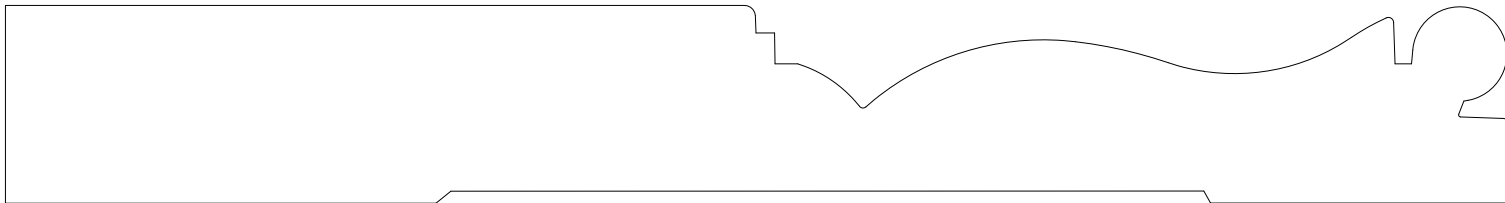

27081

EST. 1879

**S T A R K**

L U M B E R C O M P A N Y

FINE WOOD MOULDING

924 W. 1st. Avenue  
 Denver, CO 80223  
 303-534-8263 Phone  
 303-534-8266 Fax

|              |          |           |              |
|--------------|----------|-----------|--------------|
| Approved by: | MM/DD/YY |           |              |
| Drawn:       |          |           |              |
| File name:   |          | Scale 1:1 | Sheet 2-7-14 |



27082



27083



27084

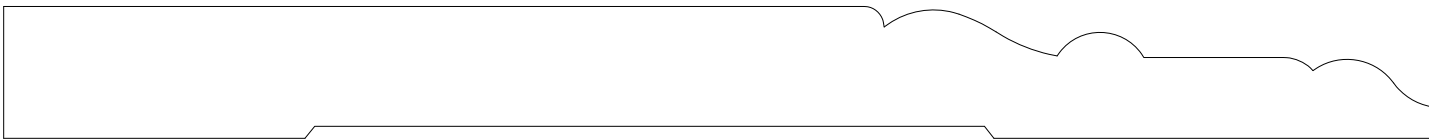

27085

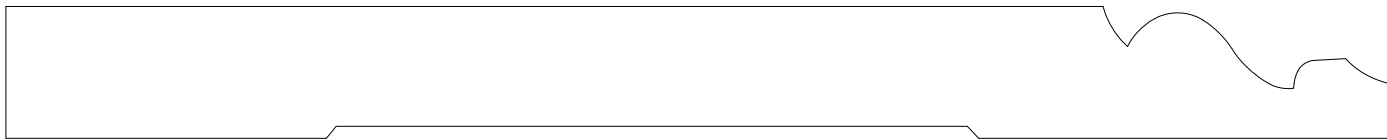

27086

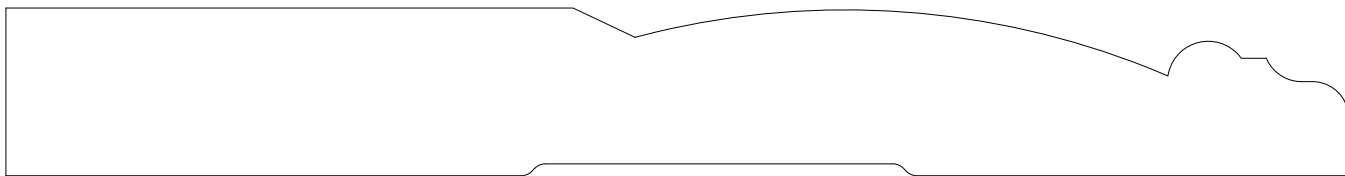

27087

EST. 1879

**S T A R K**

L U M B E R C O M P A N Y

FINE WOOD MOULDING

924 W. 1st. Avenue  
 Denver, CO 80223  
 303-534-8263 Phone  
 303-534-8266 Fax

|              |          |           |              |
|--------------|----------|-----------|--------------|
| Approved by: | MM/DD/YY |           |              |
| Drawn:       |          |           |              |
| File name:   |          | Scale 1:1 | Sheet 2-7-15 |



27088

EST. 1879  
**S T A R K**  
L U M B E R C O M P A N Y  
FINE WOOD MOULDING

924 W. 1st. Avenue  
Denver, CO 80223  
303-534-8263 Phone  
303-534-8266 Fax

|              |          |  |           |              |
|--------------|----------|--|-----------|--------------|
| Approved by: | MM/DD/YY |  | Scale 1:1 | Sheet 2-7-16 |
| Drawn:       |          |  |           |              |
| File name:   |          |  |           |              |

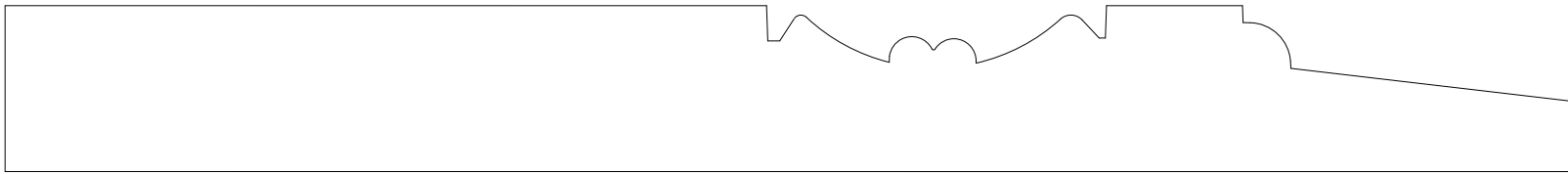

28001



28002



28003

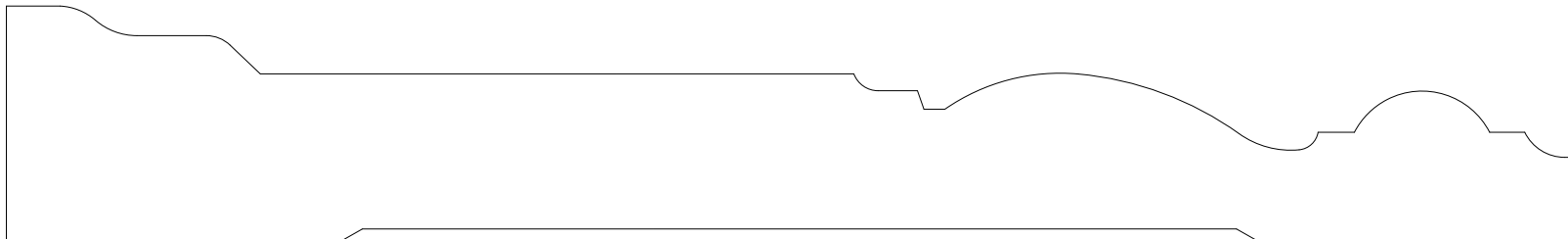

28004

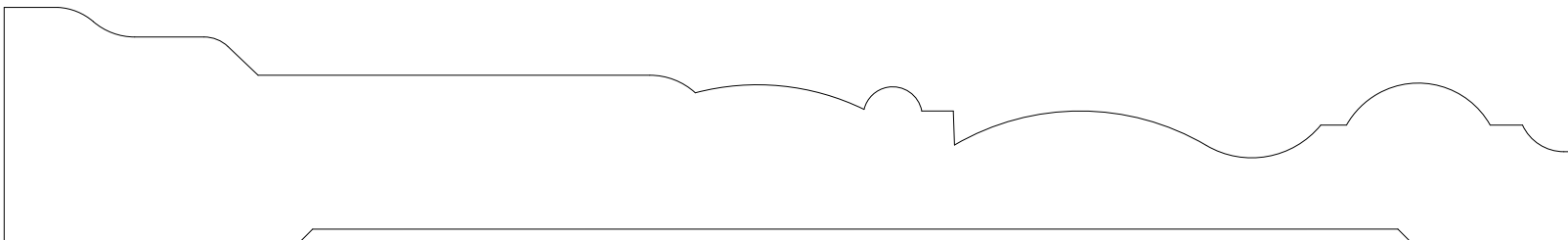

28005

|  |   |
|--|---|
|  | 924 W. 1st. Avenue<br>Denver, CO 80223<br>303-534-8263<br>Phone |
|  | 303-534-8266 Fax  |

|  |
|--|
|  |
|--|

|              |          |
|--------------|----------|
| Approved by: | MM/DD/YY |
| Drawn:       |          |
| File name:   |          |

|           |             |
|-----------|-------------|
| Scale 1:1 | Sheet 2-8-1 |
|-----------|-------------|





28006



28007



28008



28009



28010



28011



924 W. 1st. Avenue  
Denver, CO 80223  
303-534-8263  
Phone

303-534-8266 Fax

Approved by:

MM/DD/YY

Drawn:

File name:

Scale 1:1

Sheet 2-8-2



28012

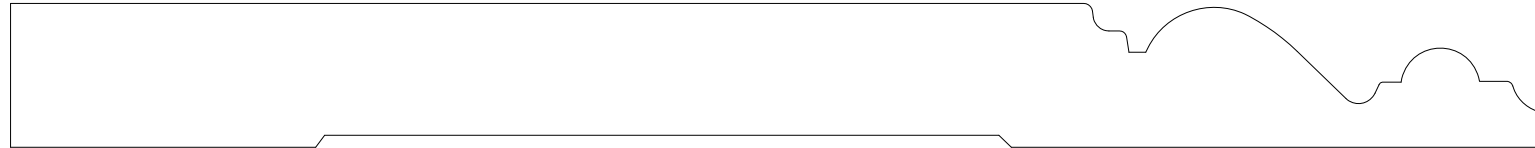

28013



28014



28015

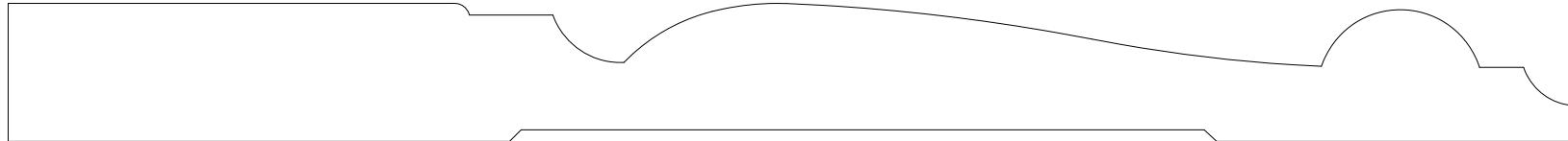

28016

EST. 1879

**S T A R K**

L U M B E R C O M P A N Y

FINE WOOD MOULDING

924 W. 1st. Avenue  
 Denver, CO 80223  
 303-534-8263 Phone  
 303-534-8266 Fax

|              |          |           |             |
|--------------|----------|-----------|-------------|
| Approved by: | MM/DD/YY |           |             |
| Drawn:       |          |           |             |
| File name:   |          | Scale 1:1 | Sheet 2-8-3 |



28017



28018

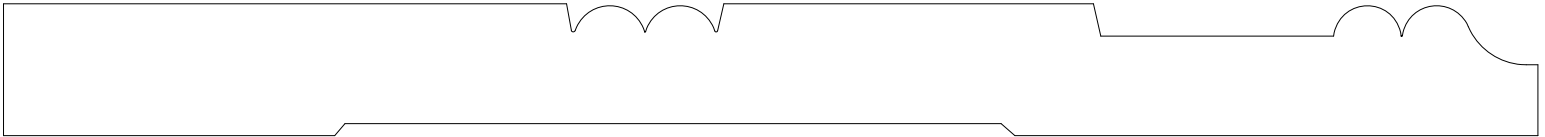

28019



28028



28046

EST. 1879

**S T A R K**

L U M B E R C O M P A N Y

FINE WOOD MOULDING

924 W. 1st. Avenue  
 Denver, CO 80223  
 303-534-8263 Phone  
 303-534-8266 Fax

|              |          |                       |
|--------------|----------|-----------------------|
| Approved by: | MM/DD/YY |                       |
| Drawn:       |          |                       |
| File name:   |          | Scale 1:1 Sheet 2-8-4 |



29001



29002

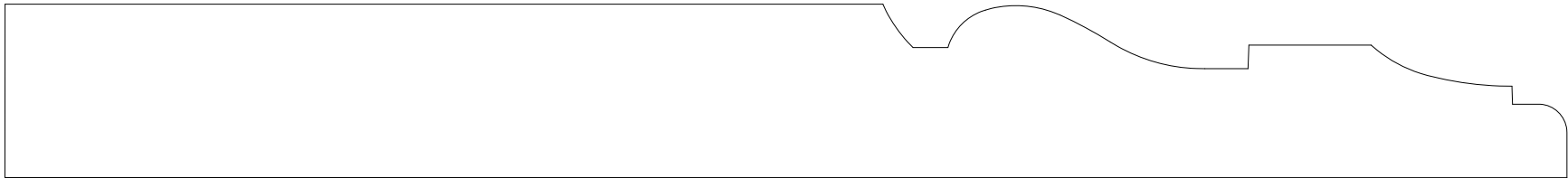

29003



29004

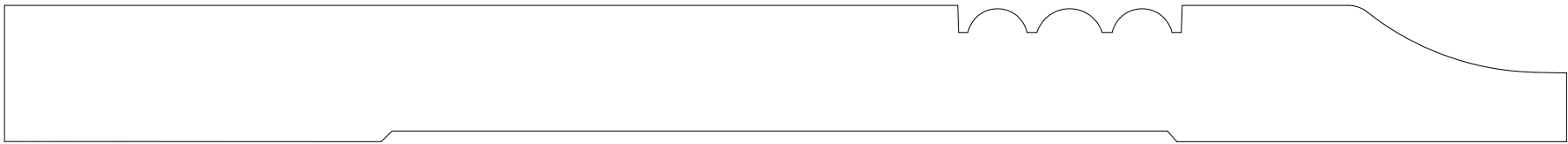

29005

EST. 1879

**S T A R K**

L U M B E R C O M P A N Y

FINE WOOD MOULDING

924 W. 1st. Avenue  
 Denver, CO 80223  
 303-534-8263 Phone  
 303-534-8266 Fax

|              |          |             |
|--------------|----------|-------------|
| Approved by: | MM/DD/YY |             |
| Drawn:       |          |             |
| File name:   |          | Scale 1:1   |
|              |          | Sheet 2-9-1 |



29006

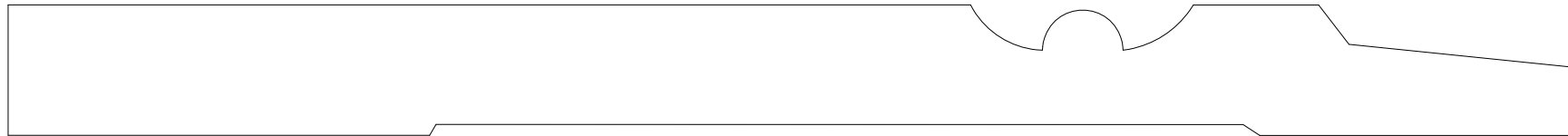

29007



29008

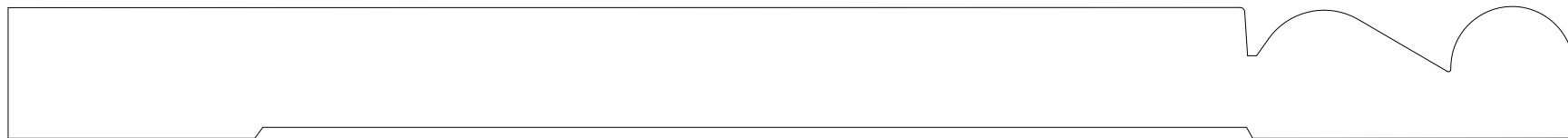

29009



29010



29011

EST. 1879

**S T A R K**

L U M B E R C O M P A N Y

FINE WOOD MOULDING

924 W. 1st. Avenue  
 Denver, CO 80223  
 303-534-8263 Phone  
 303-534-8266 Fax

|              |          |           |             |
|--------------|----------|-----------|-------------|
| Approved by: | MM/DD/YY |           |             |
| Drawn:       |          |           |             |
| File name:   |          | Scale 1:1 | Sheet 2-9-2 |

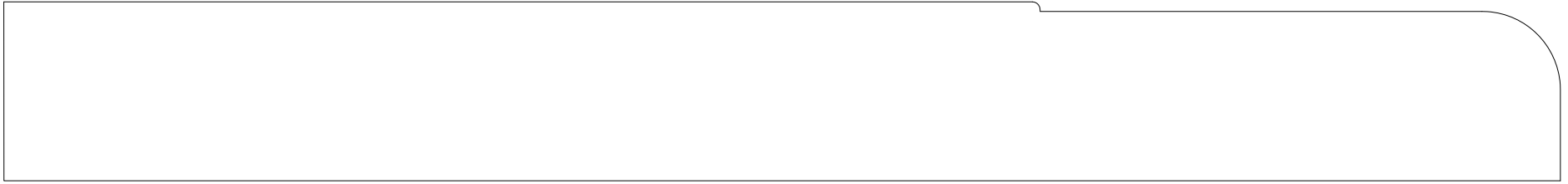

29012



29036

|  |  |
|--|--|
|  | 924 W. 1st. Avenue<br>Denver, CO 80223<br>303-534-8263 Phone<br>303-534-8266 Fax |
|  |  |

|              |          |           |             |
|--------------|----------|-----------|-------------|
| Approved by: | MM/DD/YY |           |             |
| Drawn:       |          |           |             |
| File name:   |          | Scale 1:1 | Sheet 2-9-3 |

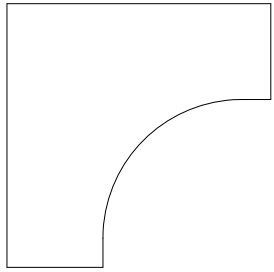

31001

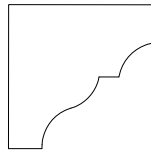

31005

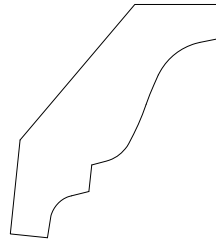

31009

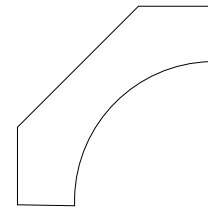

31013

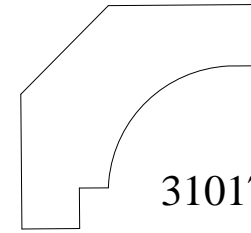

31017

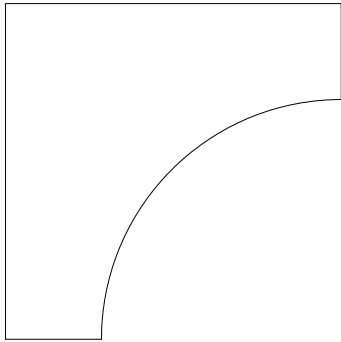

31002

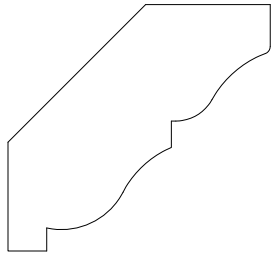

31006

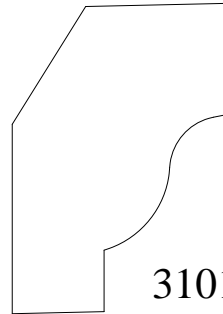

31010

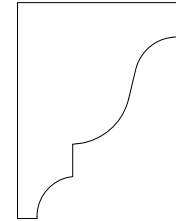

31014

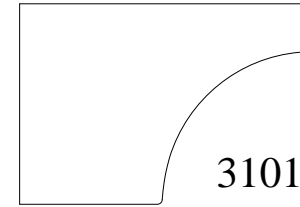

31018

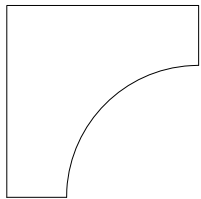

31003

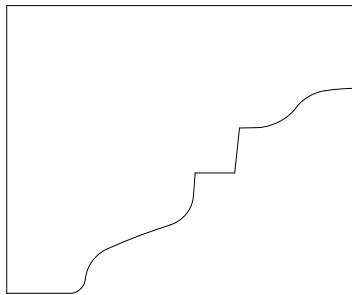

31007

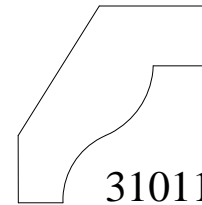

31011

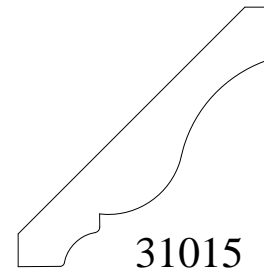

31015

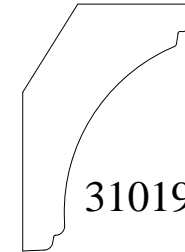

31019

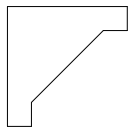

31004

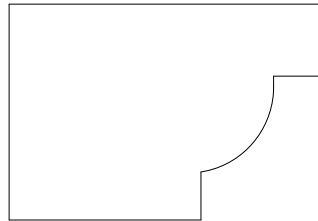

31008

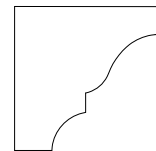

31012

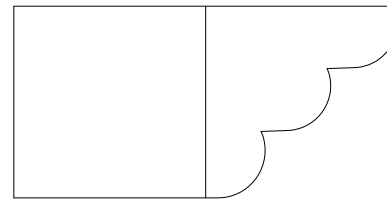

31016

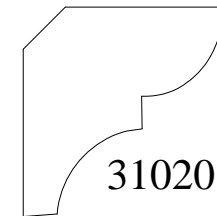

31020

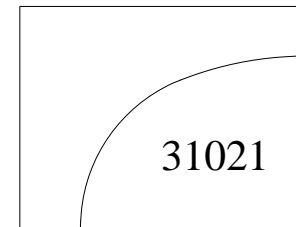

31021

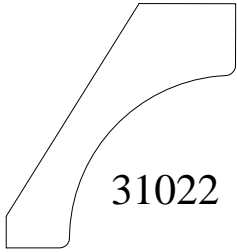

31022

EST. 1879  
**S T A R K**  
L U M B E R C O M P A N Y  
FINE WOOD MOULDING

924 W. 1st. Avenue  
Denver, CO 80223  
303-534-8263 Phone  
303-534-8266 Fax

|              |          |           |             |
|--------------|----------|-----------|-------------|
| Approved by: | MM/DD/YY |           |             |
| Drawn:       |          |           |             |
| File name:   |          | Scale 1:1 | Sheet 3-1-2 |



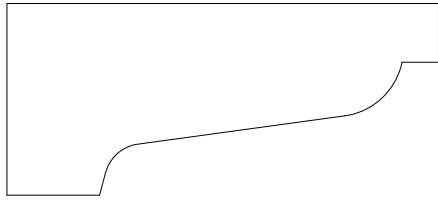

32001

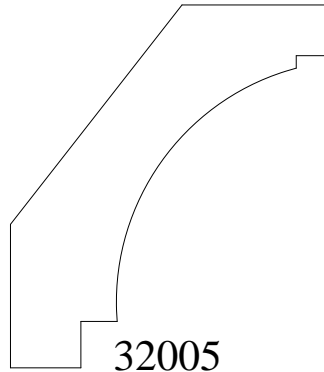

32005

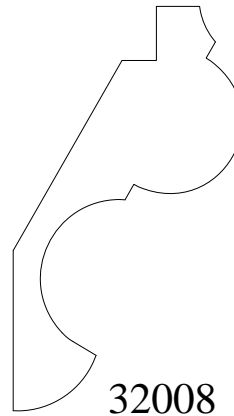

32008

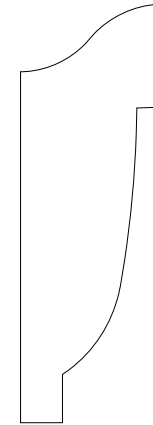

32011

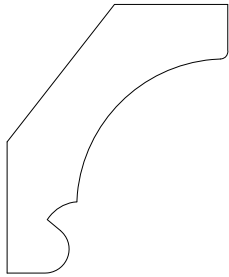

32002

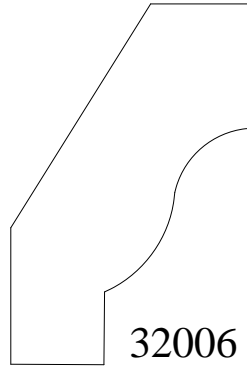

32006

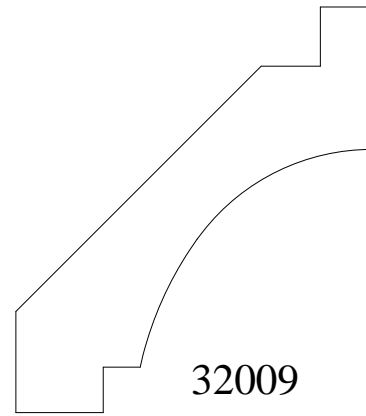

32009

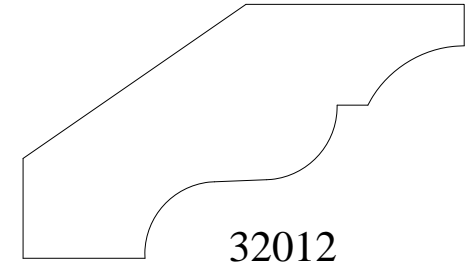

32012

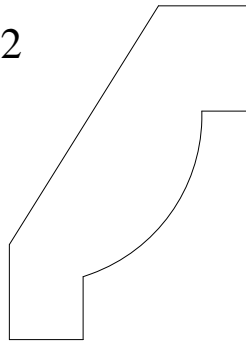

32003

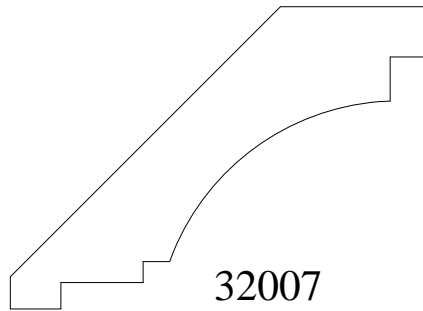

32007

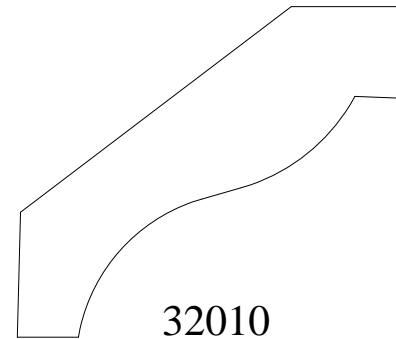

32010

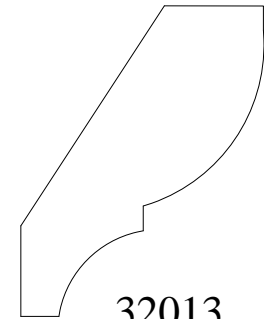

32013

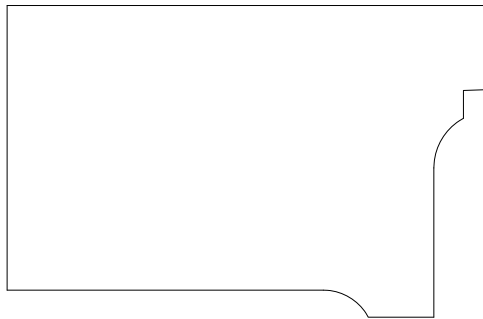

32004

EST. 1879

**S T A R K**

L U M B E R C O M P A N Y

FINE WOOD MOULDING

924 W. 1st. Avenue  
 Denver, CO 80223  
 303-534-8263 Phone  
 303-534-8266 Fax

|              |          |             |
|--------------|----------|-------------|
| Approved by: | MM/DD/YY |             |
| Drawn:       |          |             |
| File name:   |          | Scale 1:1   |
|              |          | Sheet 3-2-1 |

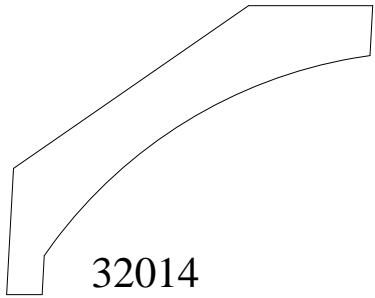

32014

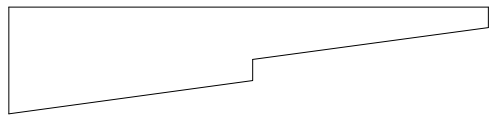

32017

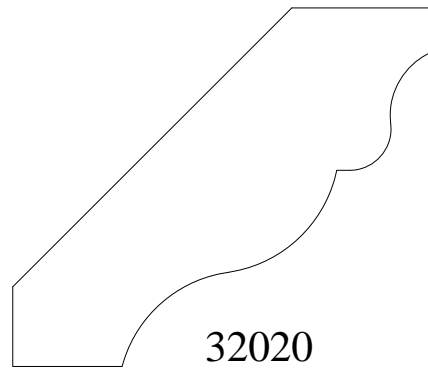

32020

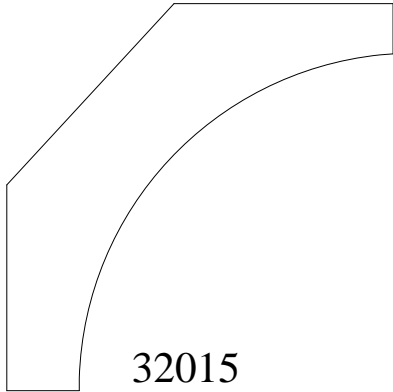

32015

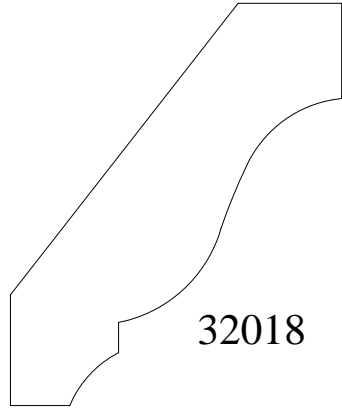

32018

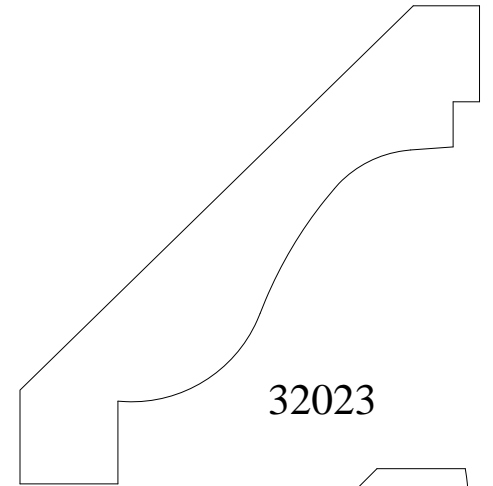

32023

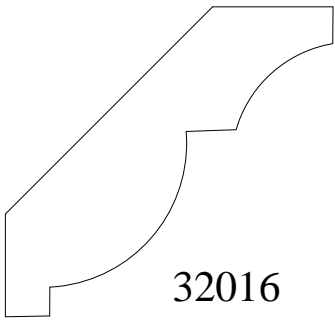

32016

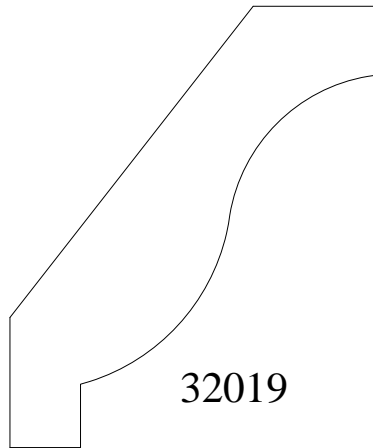

32019

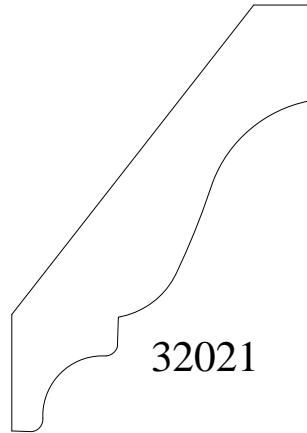

32021

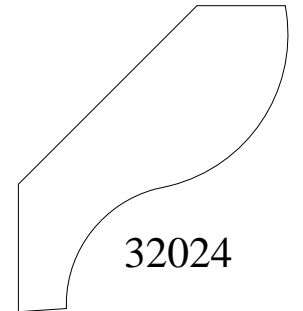

32024

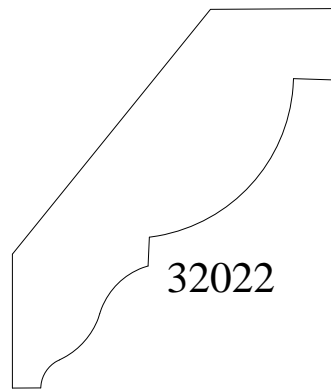

32022

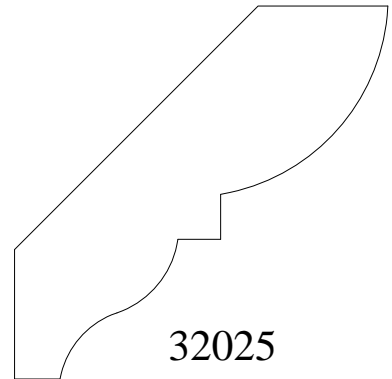

32025

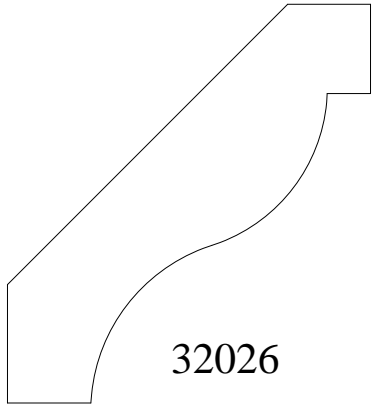

32026

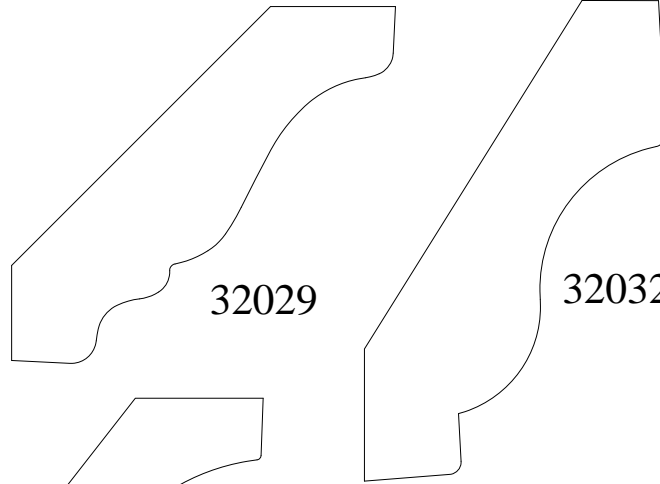

32029

32032

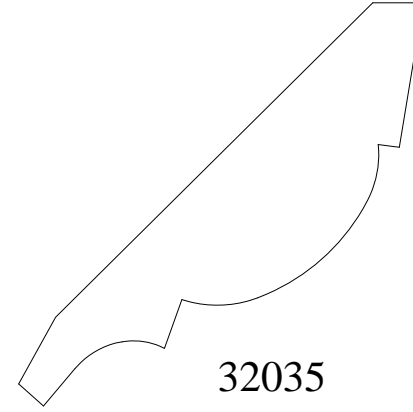

32035

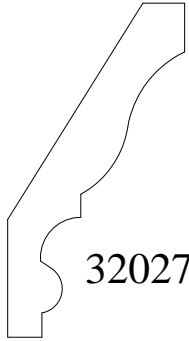

32027

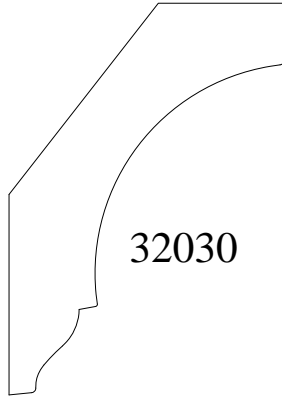

32030

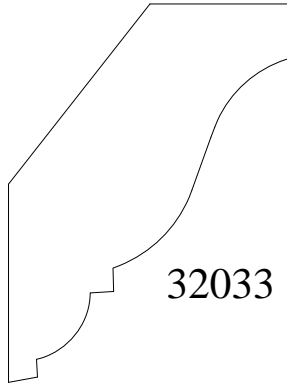

32033

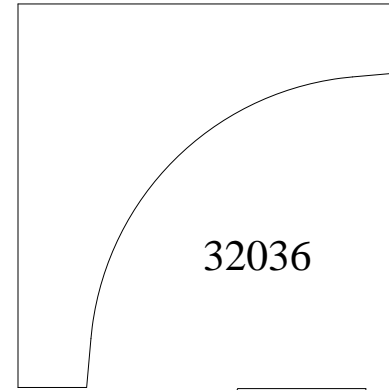

32036

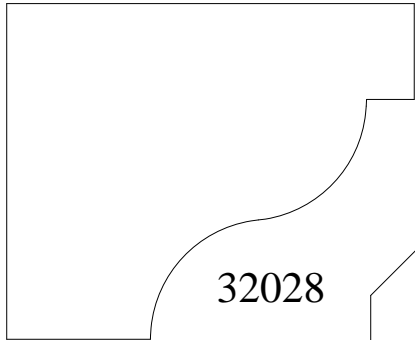

32028

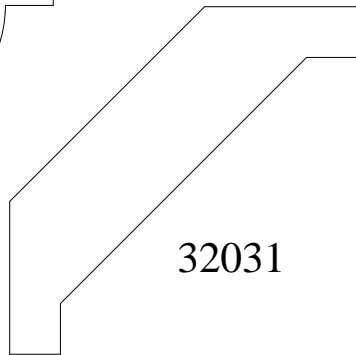

32031

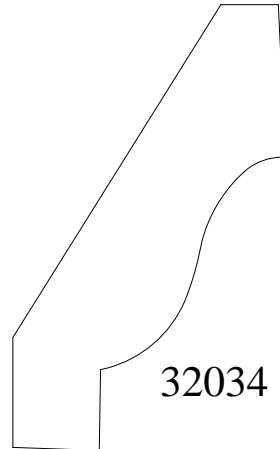

32034

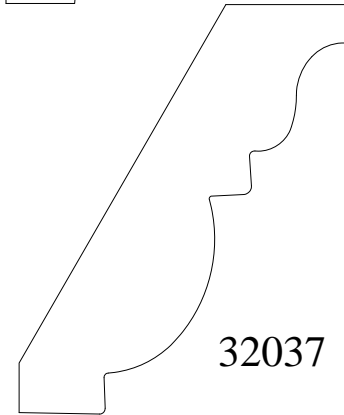

32037

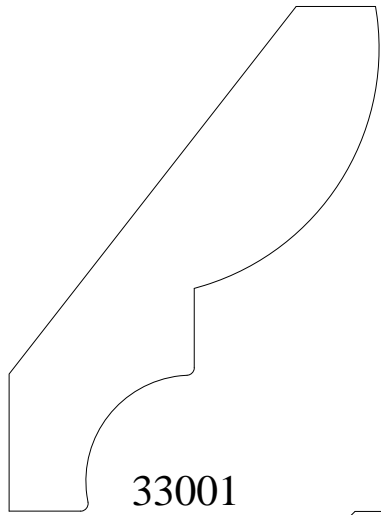

33001

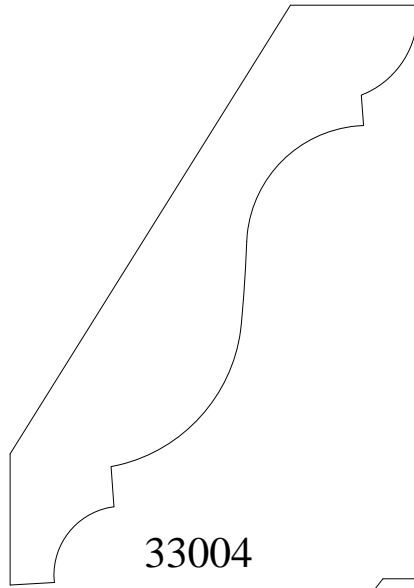

33004

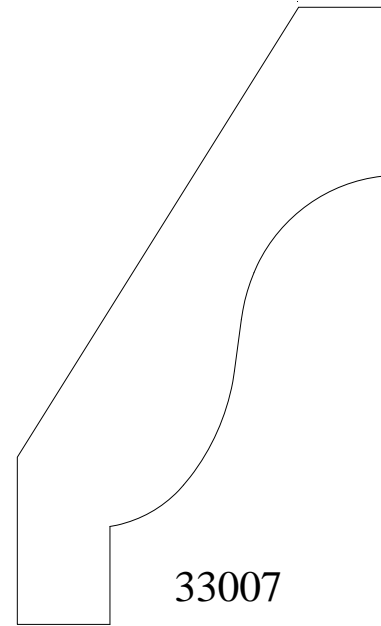

33007

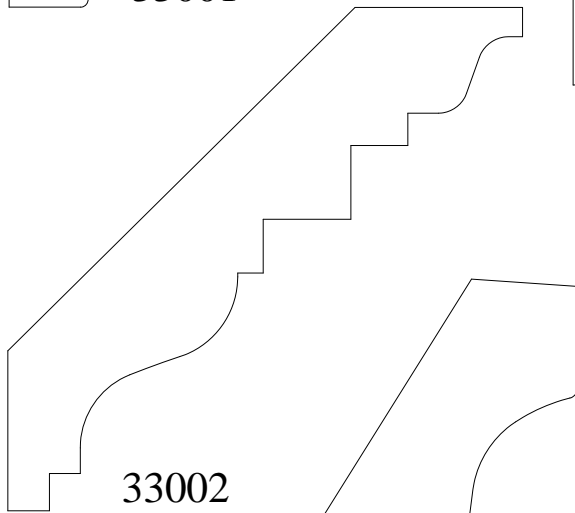

33002

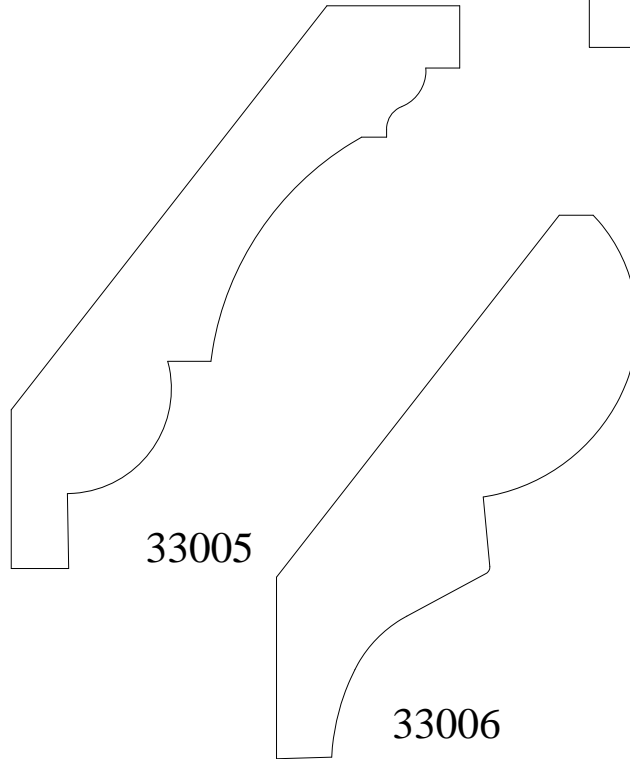

33005

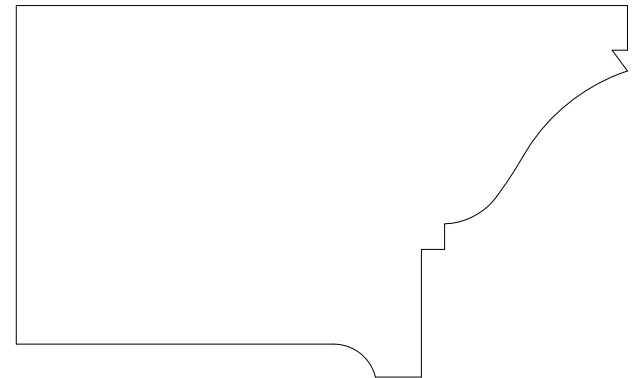

33008

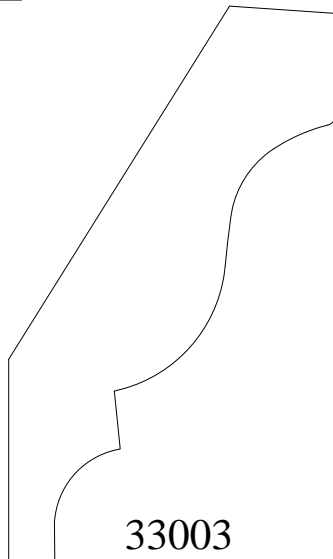

33003

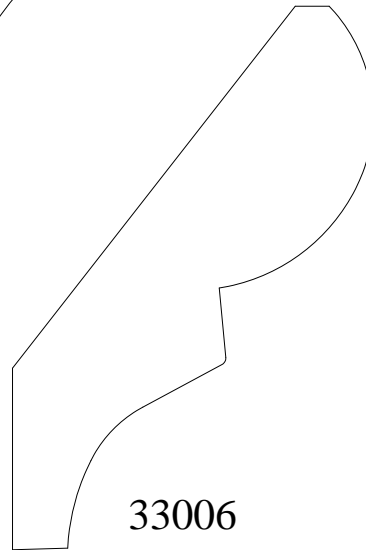

33006

EST. 1879

**S T A R K**

L U M B E R C O M P A N Y

FINE WOOD MOULDING

924 W. 1st. Avenue  
 Denver, CO 80223  
 303-534-8263 Phone  
 303-534-8266 Fax

|              |          |             |
|--------------|----------|-------------|
| Approved by: | MM/DD/YY |             |
| Drawn:       |          |             |
| File name:   |          | Scale 1:1   |
|              |          | Sheet 3-3-1 |

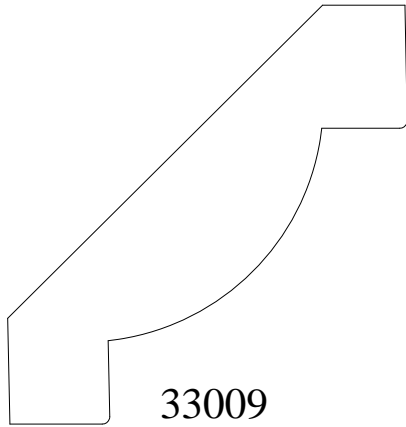

33009

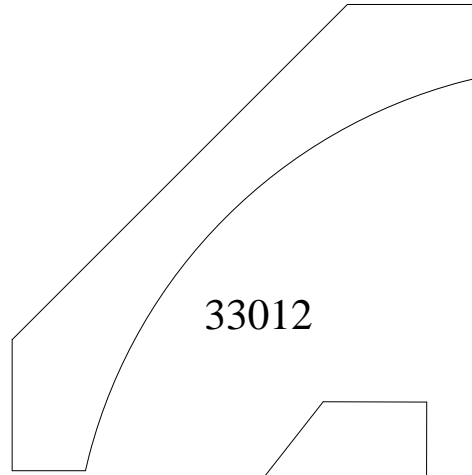

33012

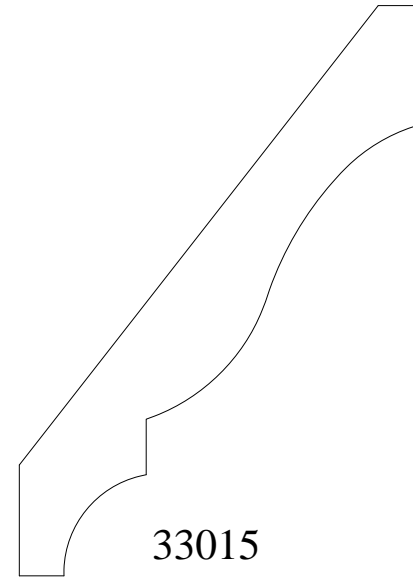

33015



33010

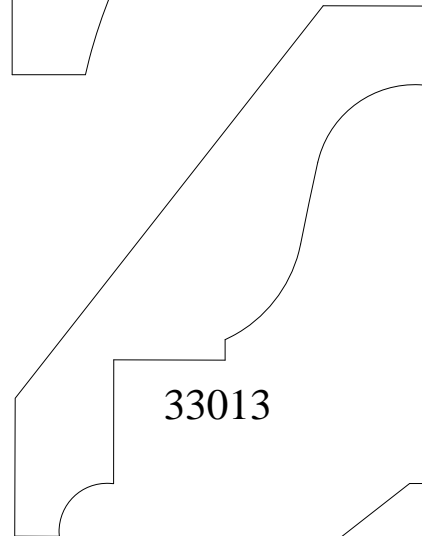

33013

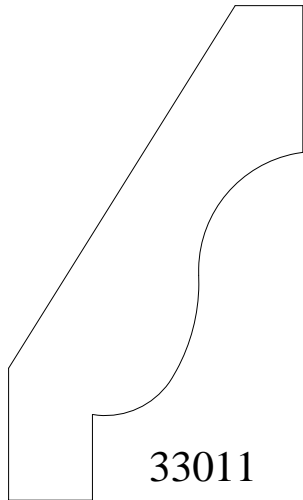

33011

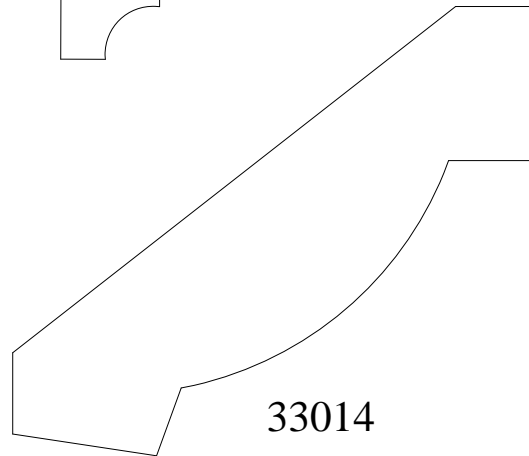

33014

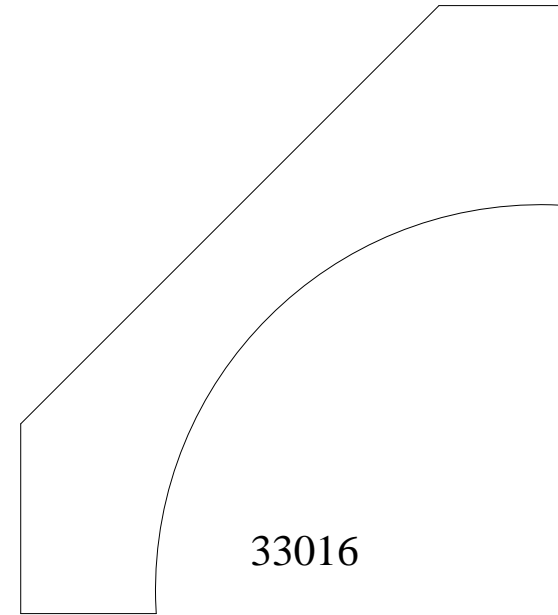

33016

EST. 1879  
**S T A R K**  
L U M B E R C O M P A N Y  
FINE WOOD MOULDING

924 W. 1st. Avenue  
Denver, CO 80223  
303-534-8263 Phone  
303-534-8266 Fax

|              |          |             |
|--------------|----------|-------------|
| Approved by: | MM/DD/YY |             |
| Drawn:       |          |             |
| File name:   |          | Scale 1:1   |
|              |          | Sheet 3-3-2 |

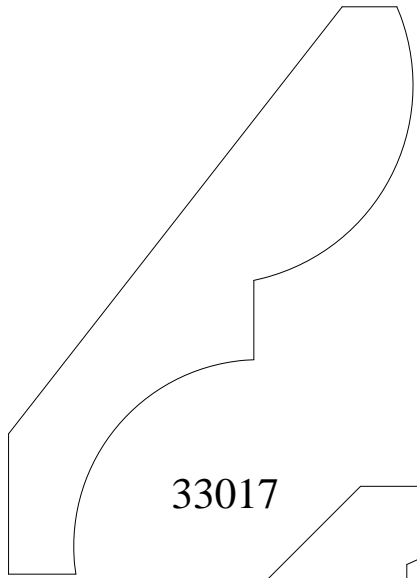

33017

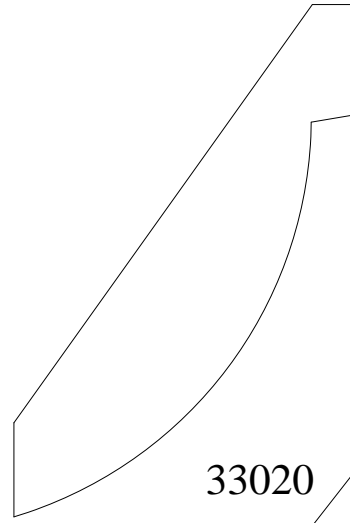

33020

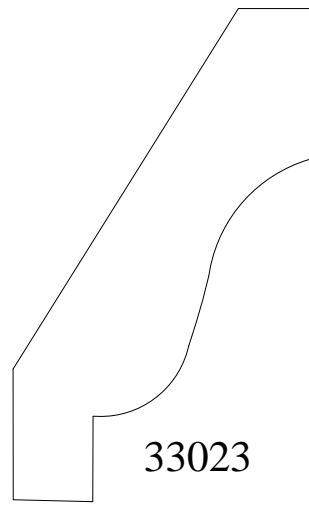

33023

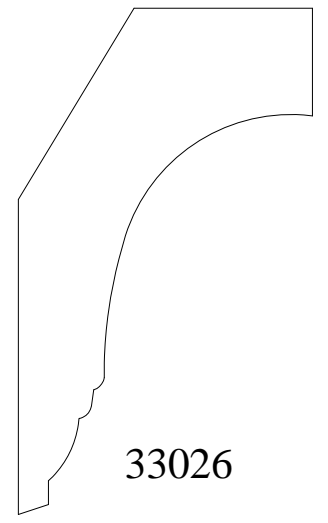

33026

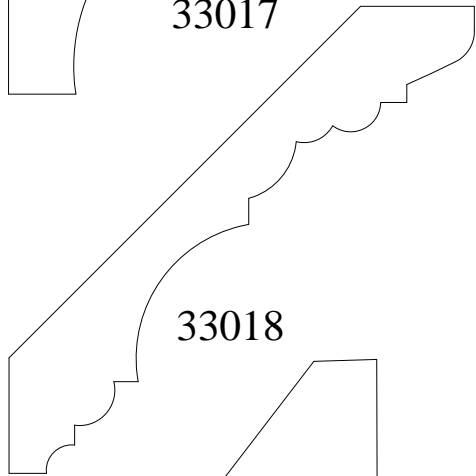

33018

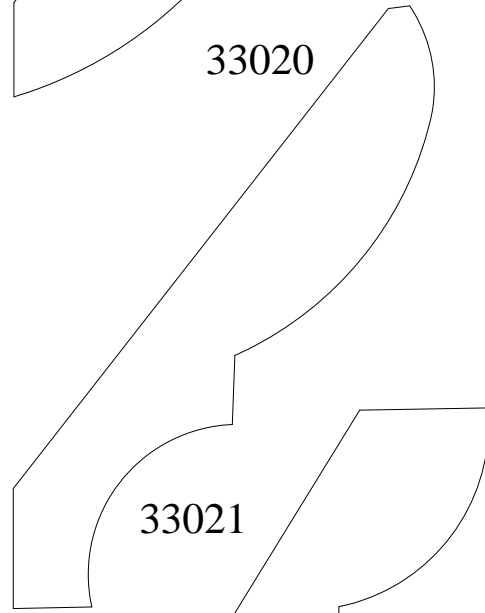

33021

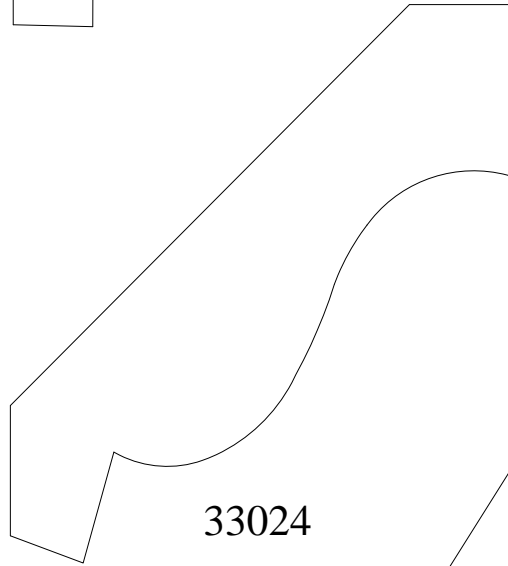

33024

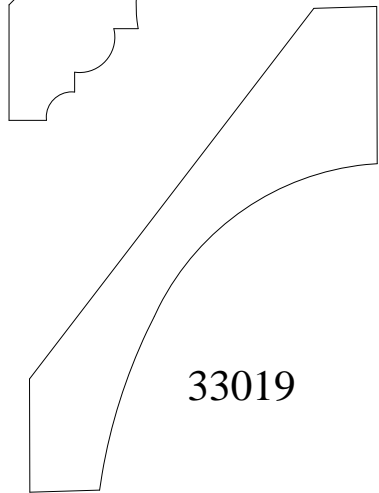

33019

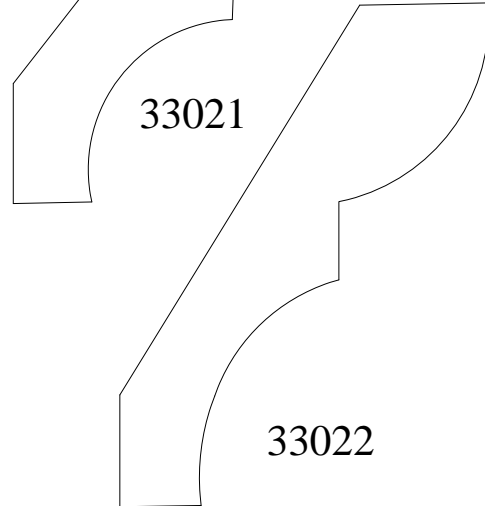

33022

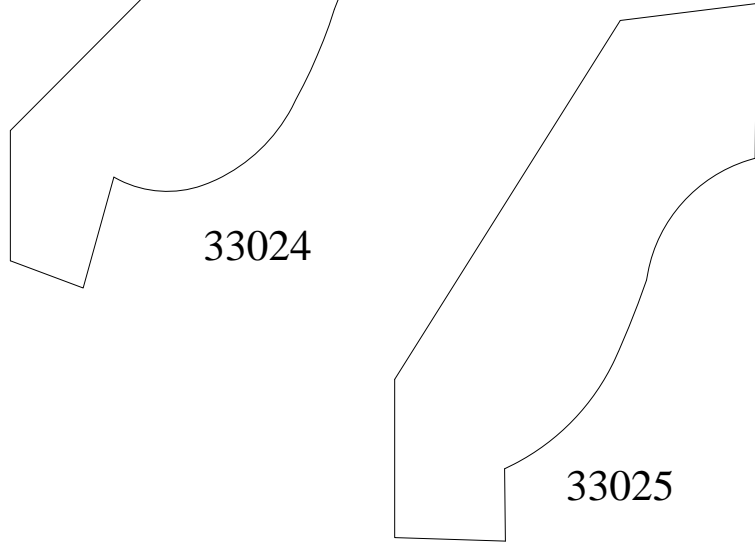

33025

EST. 1879

**S T A R K**

L U M B E R C O M P A N Y

FINE WOOD MOULDING

924 W. 1st. Avenue  
 Denver, CO 80223  
 303-534-8263 Phone  
 303-534-8266 Fax

|              |          |             |
|--------------|----------|-------------|
| Approved by: | MM/DD/YY |             |
| Drawn:       |          |             |
| File name:   |          | Scale 1:1   |
|              |          | Sheet 3-3-3 |

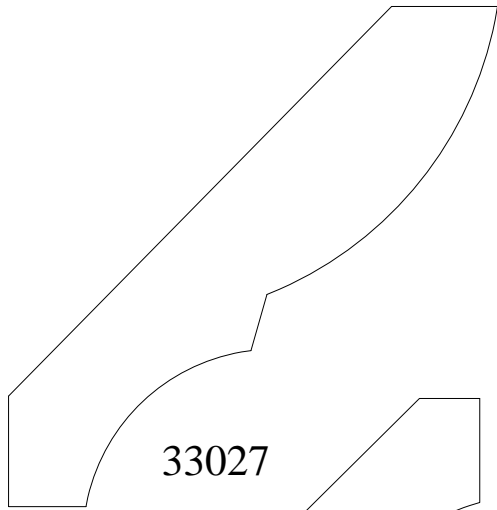

33027

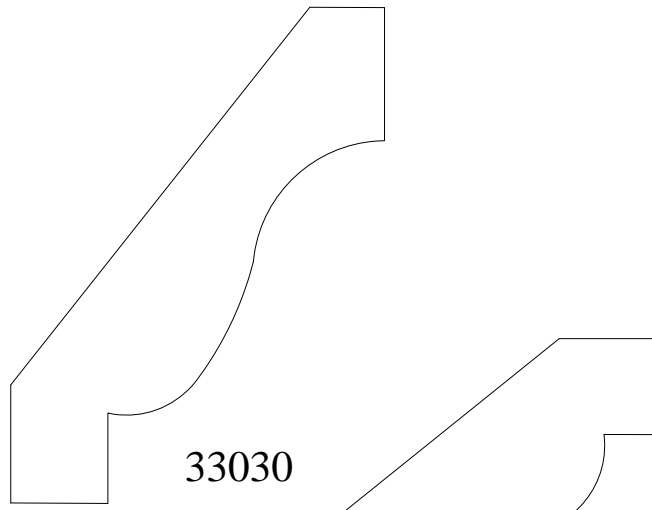

33030

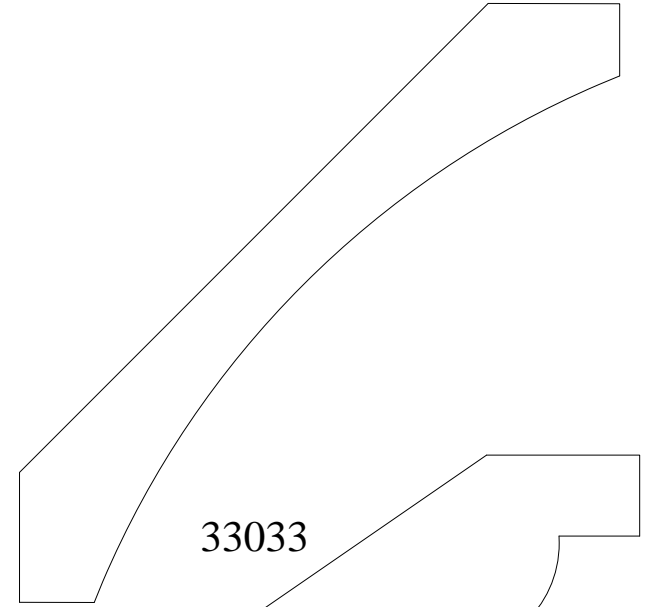

33033

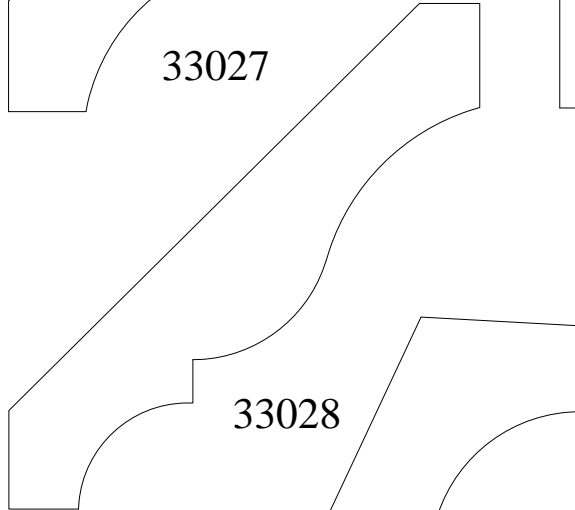

33028

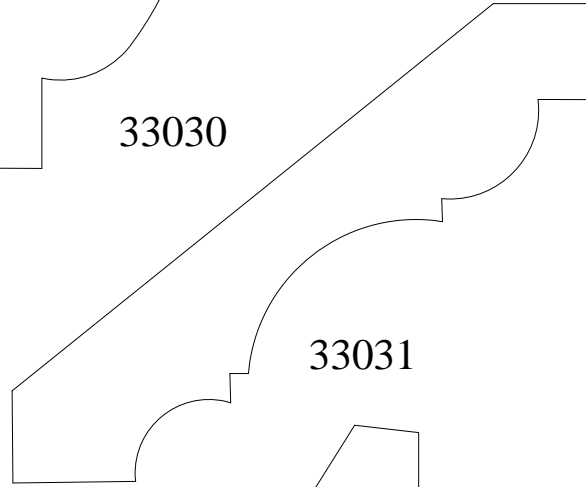

33031

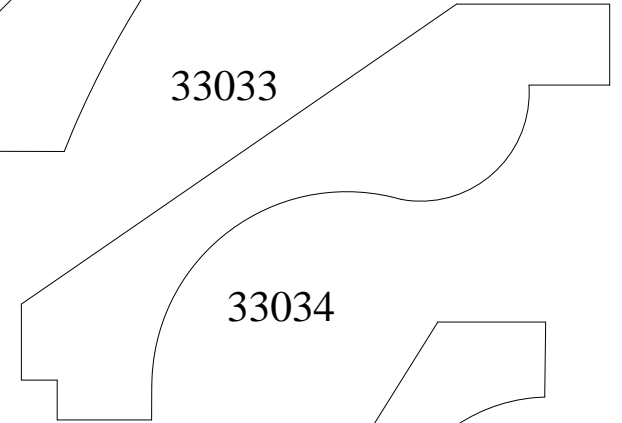

33034

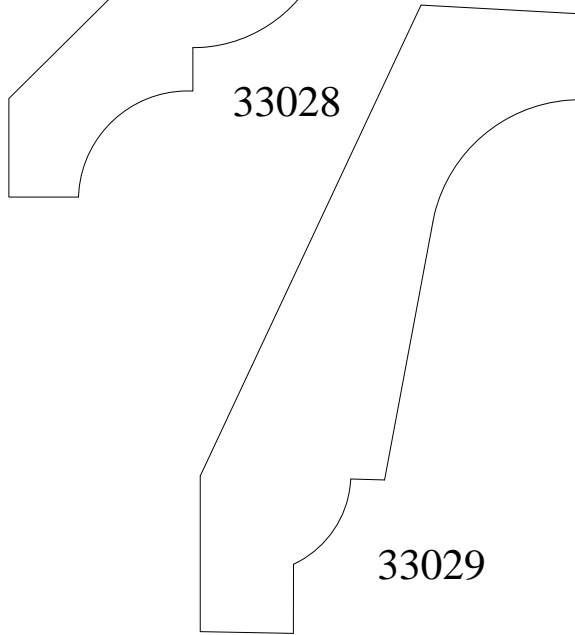

33029

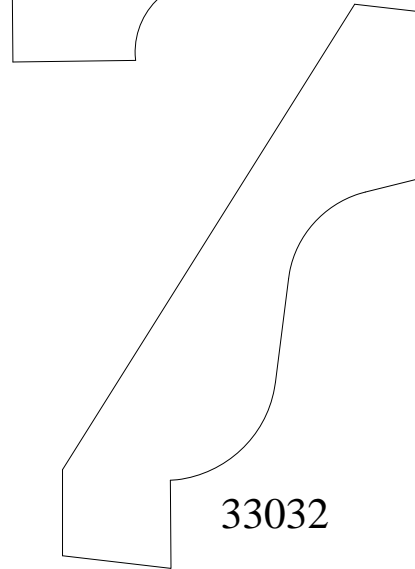

33032

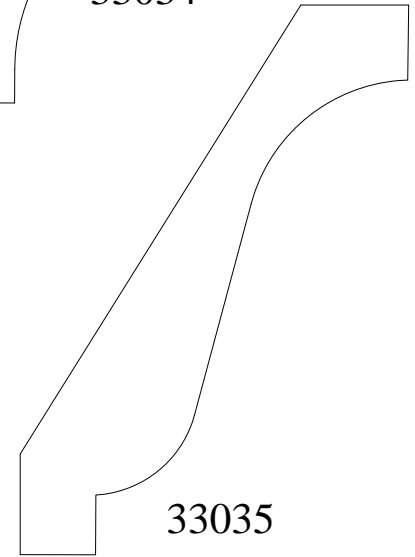

33035

EST. 1879  
**S T A R K**  
L U M B E R C O M P A N Y  
FINE WOOD MOULDING

924 W. 1st. Avenue  
Denver, CO 80223  
303-534-8263 Phone  
303-534-8266 Fax

|              |          |  |           |             |
|--------------|----------|--|-----------|-------------|
| Approved by: | MM/DD/YY |  | Scale 1:1 | Sheet 3-3-4 |
| Drawn:       |          |  |           |             |
| File name:   |          |  |           |             |

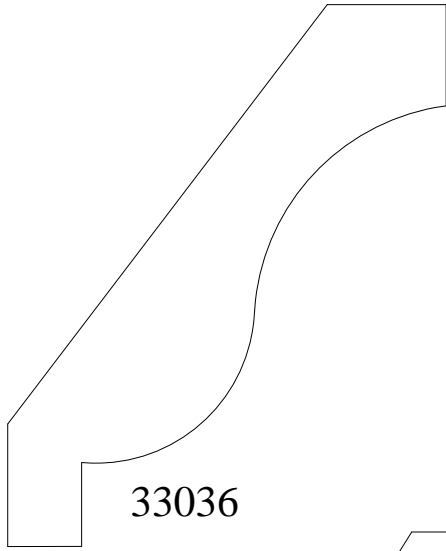

33036

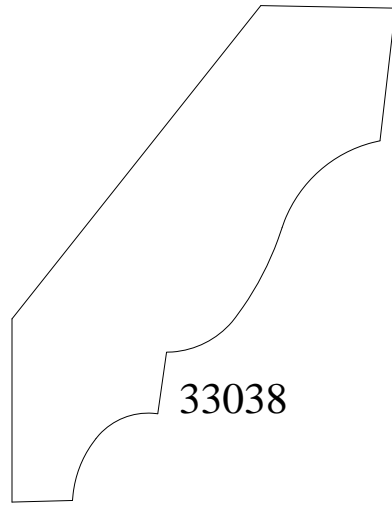

33038

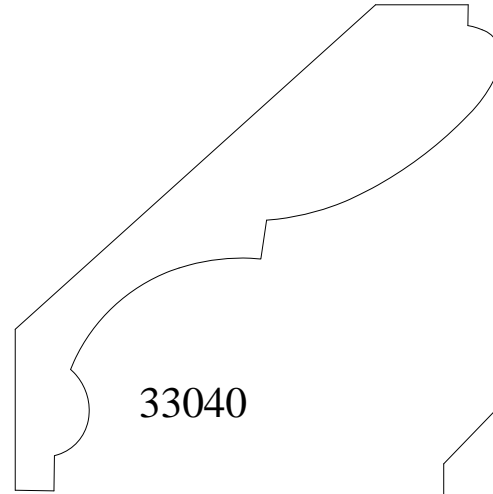

33040

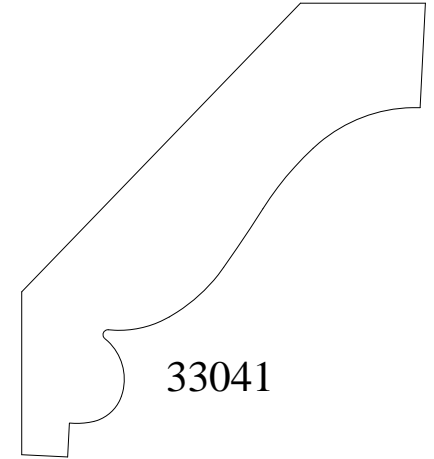

33041

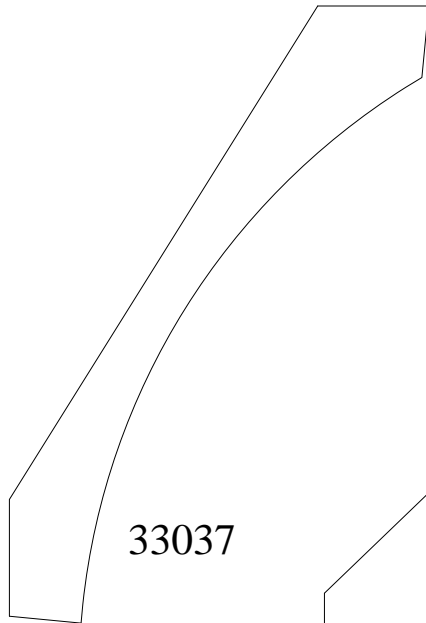

33037

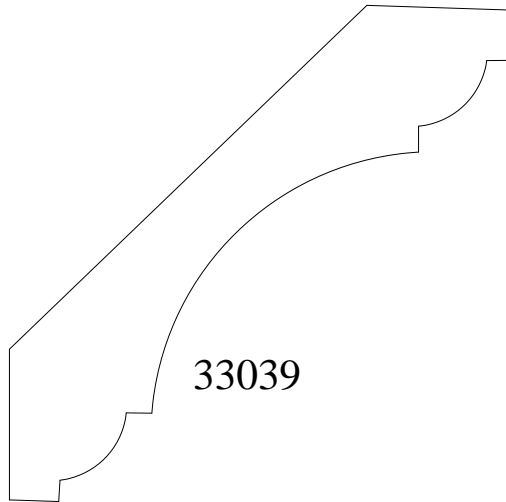

33039

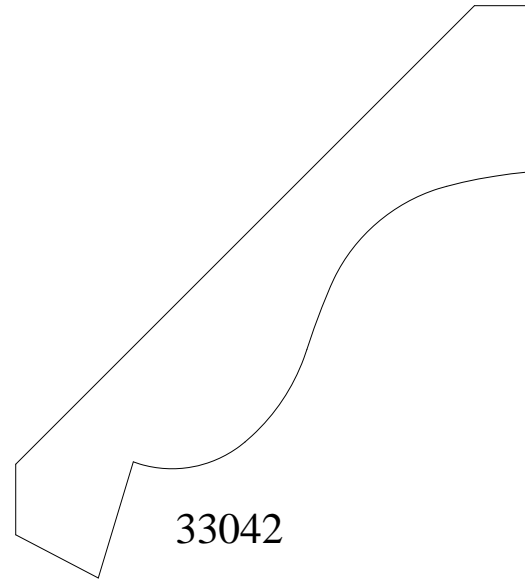

33042

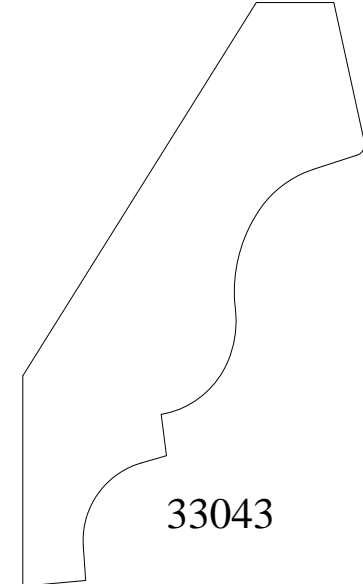

33043

EST. 1879  
**S T A R K**  
L U M B E R C O M P A N Y  
FINE WOOD MOULDING

924 W. 1st. Avenue  
Denver, CO 80223  
303-534-8263 Phone  
303-534-8266 Fax

|              |          |                       |
|--------------|----------|-----------------------|
| Approved by: | MM/DD/YY |                       |
| Drawn:       |          |                       |
| File name:   |          | Scale 1:1 Sheet 3-3-5 |



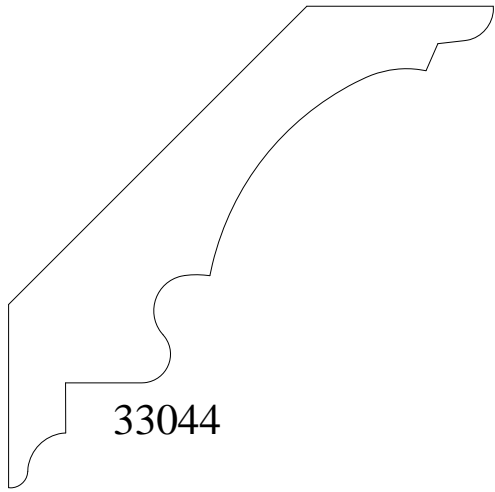

33044

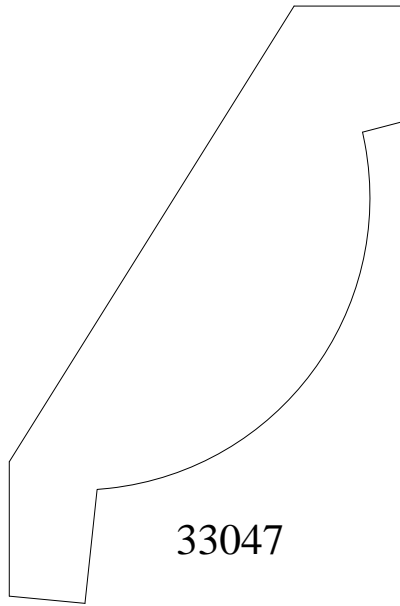

33047

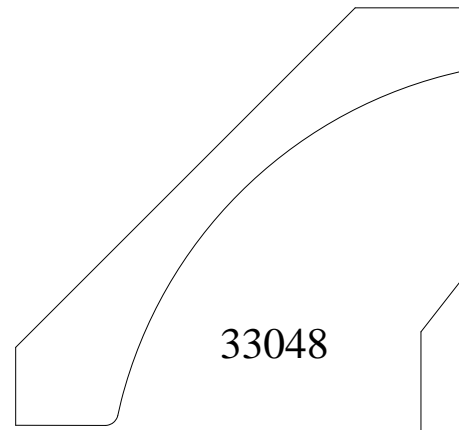

33048



33051

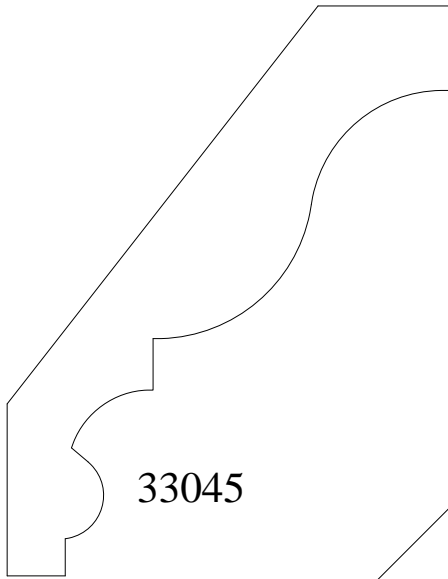

33045

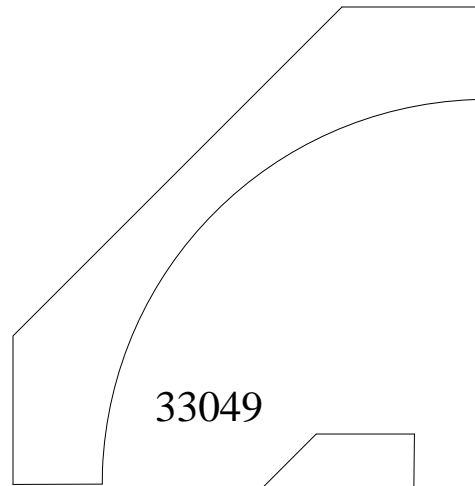

33049

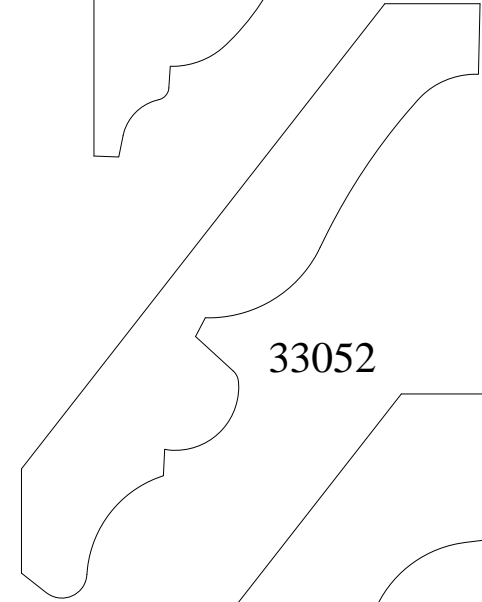

33052

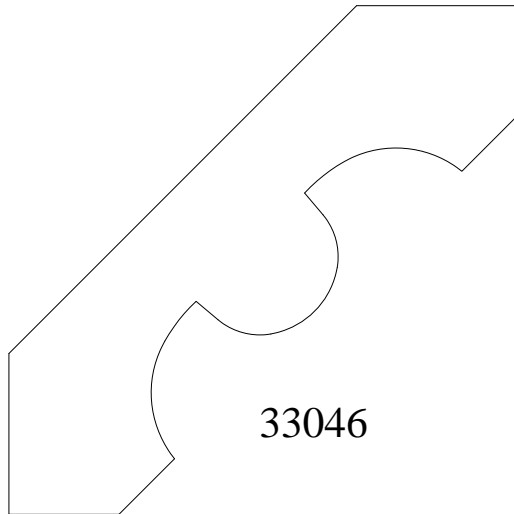

33046

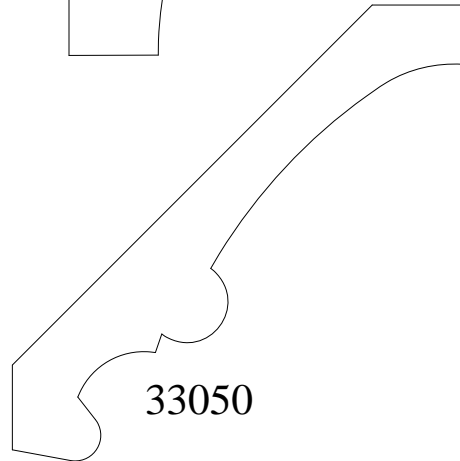

33050

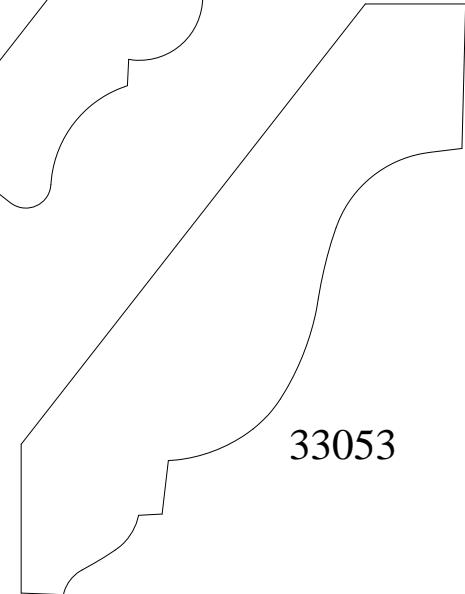

33053

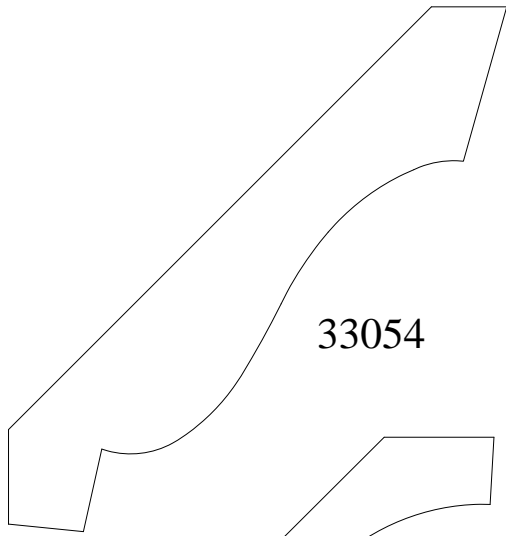

33054



33057

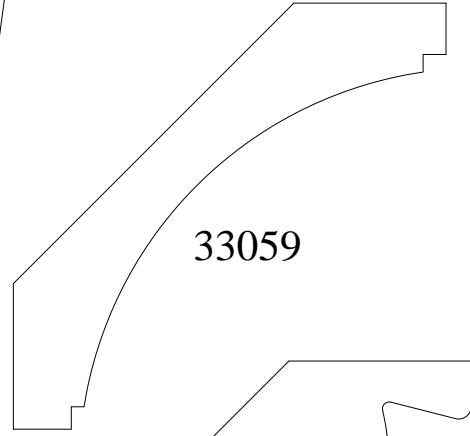

33059

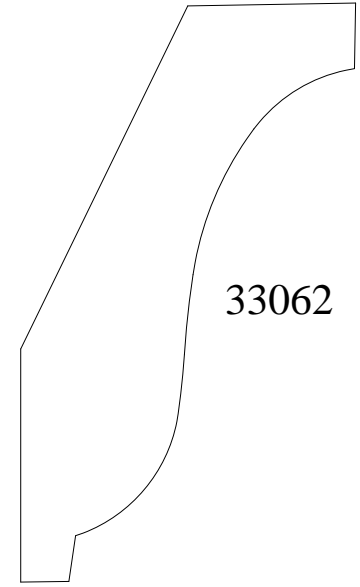

33062

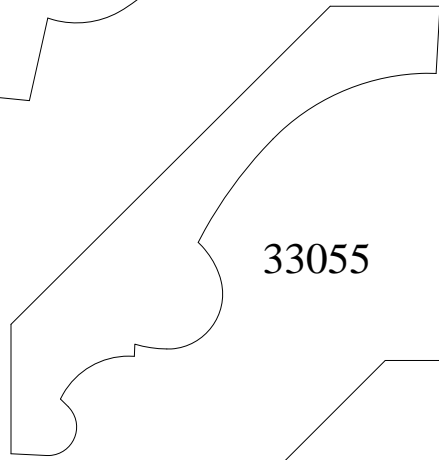

33055

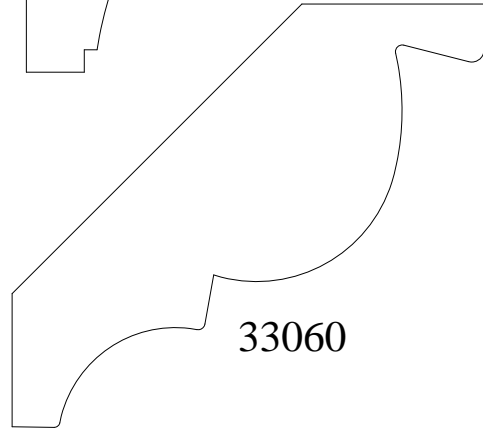

33060

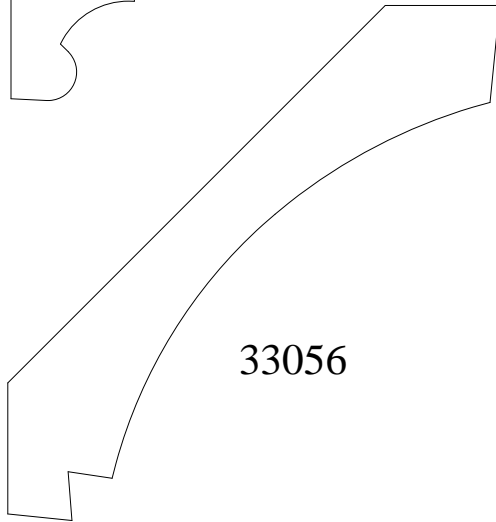

33056

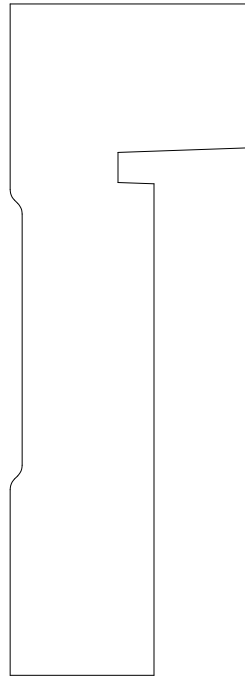

33058

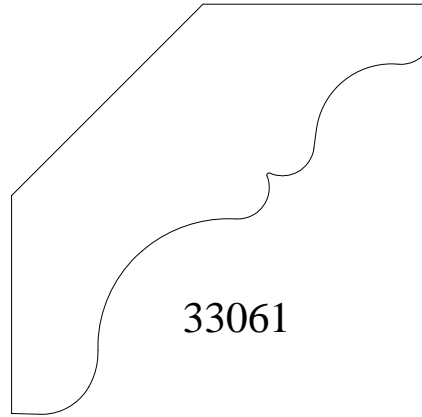

33061

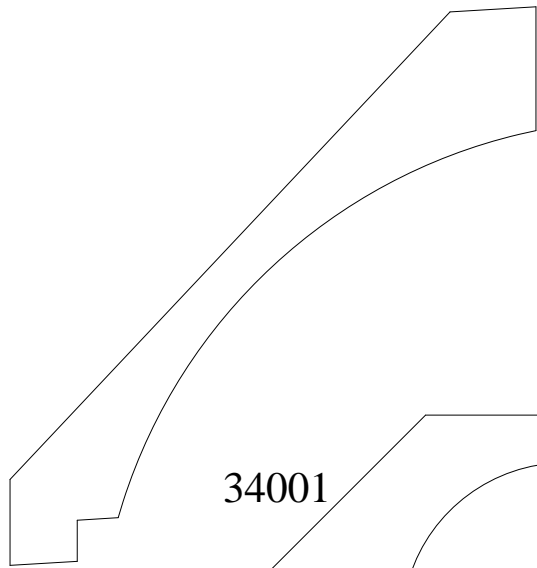

34001

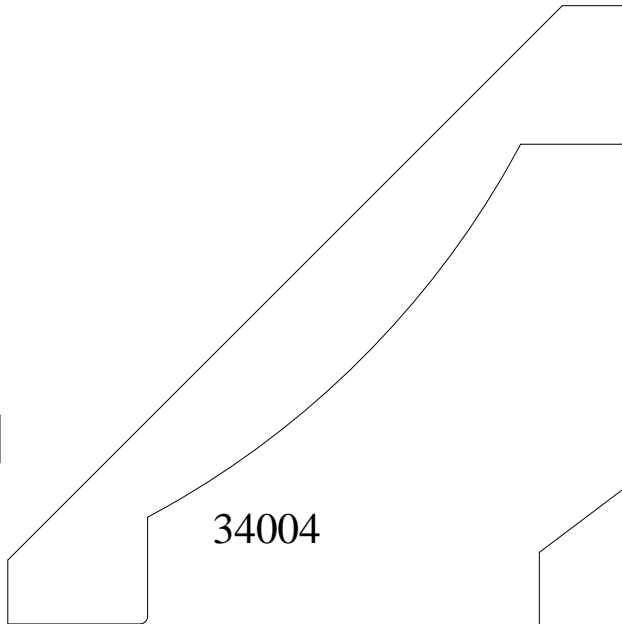

34004

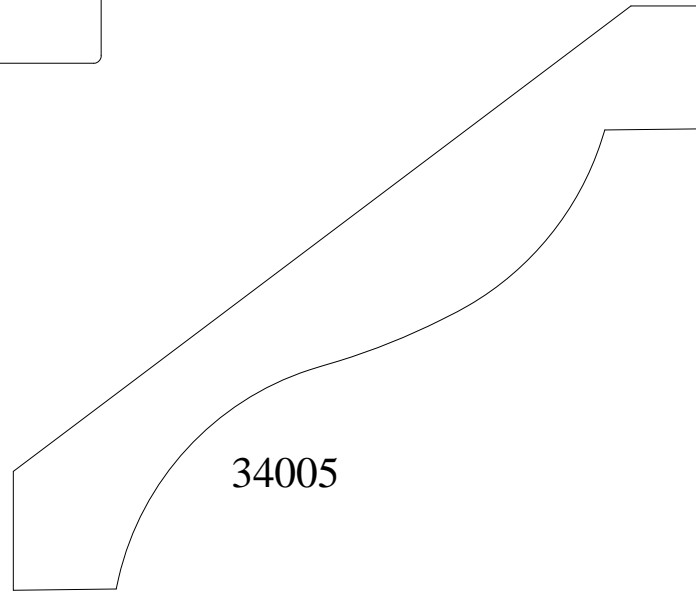

34005

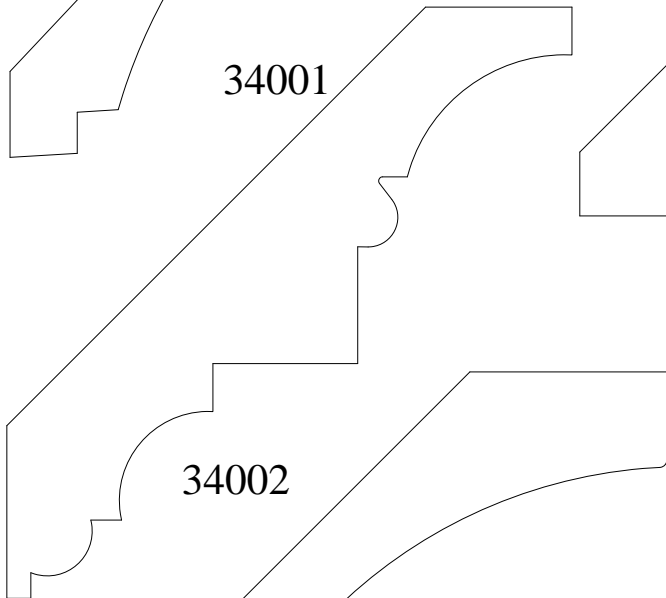

34002

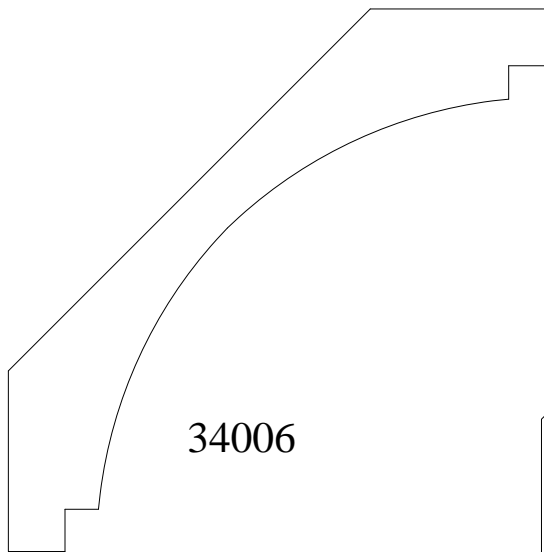

34006



34007

EST. 1879

**S T A R K**

L U M B E R C O M P A N Y

FINE WOOD MOULDING

924 W. 1st. Avenue  
 Denver, CO 80223  
 303-534-8263 Phone  
 303-534-8266 Fax

|              |          |             |
|--------------|----------|-------------|
| Approved by: | MM/DD/YY |             |
| Drawn:       |          |             |
| File name:   |          | Scale 1:1   |
|              |          | Sheet 3-4-1 |



34008

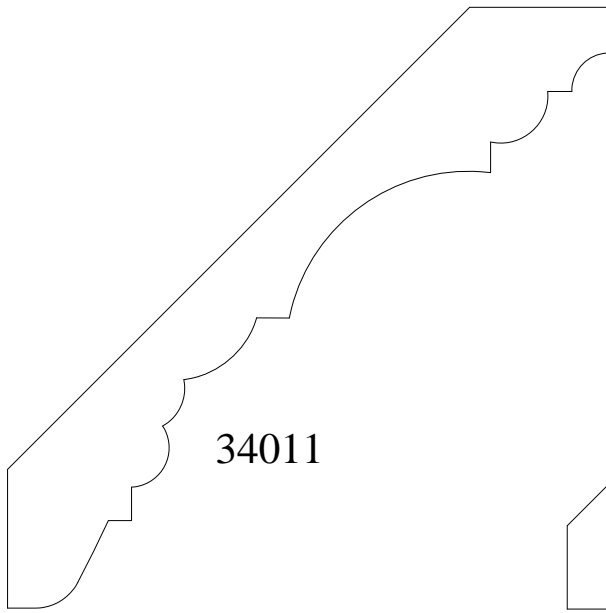

34011

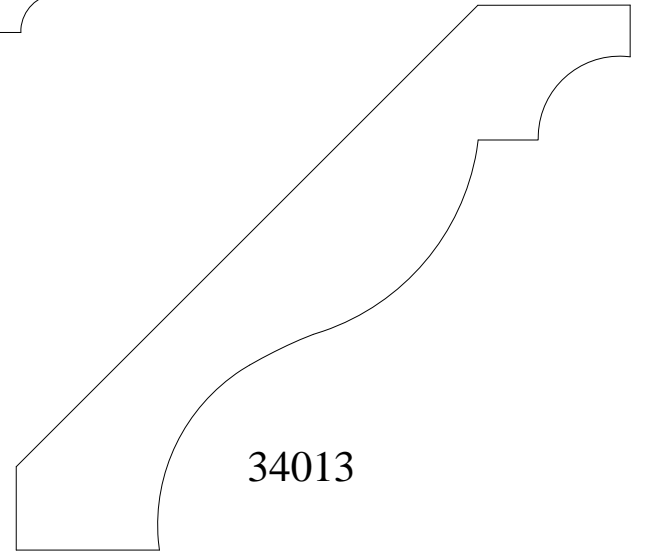

34013

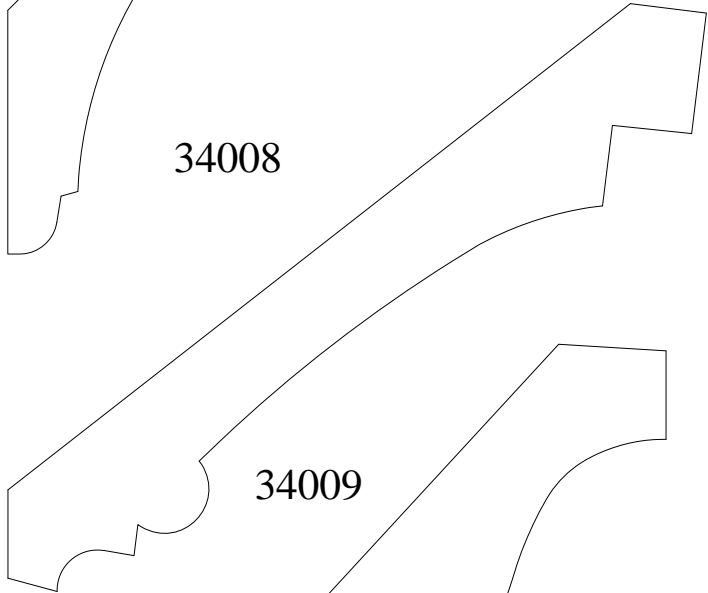

34009



34010

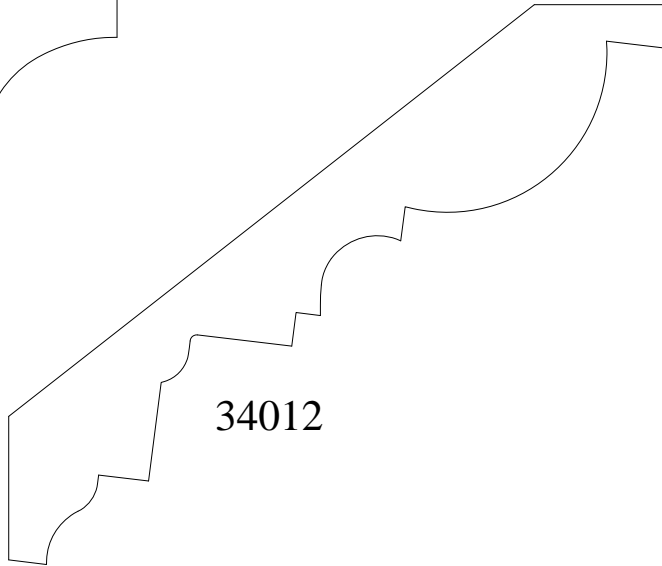

34012

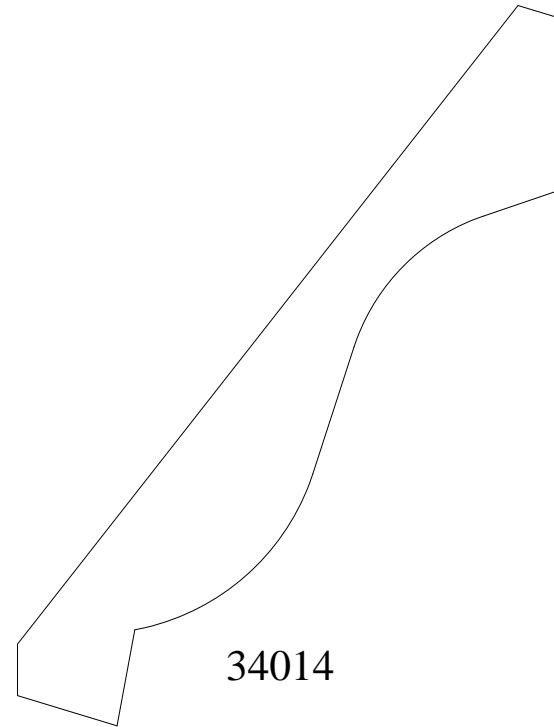

34014



924 W. 1st. Avenue  
Denver, CO 80223  
303-534-8263 Phone  
303-534-8266 Fax

|              |          |             |
|--------------|----------|-------------|
| Approved by: | MM/DD/YY |             |
| Drawn:       |          |             |
| File name:   |          | Scale 1:1   |
|              |          | Sheet 3-4-2 |

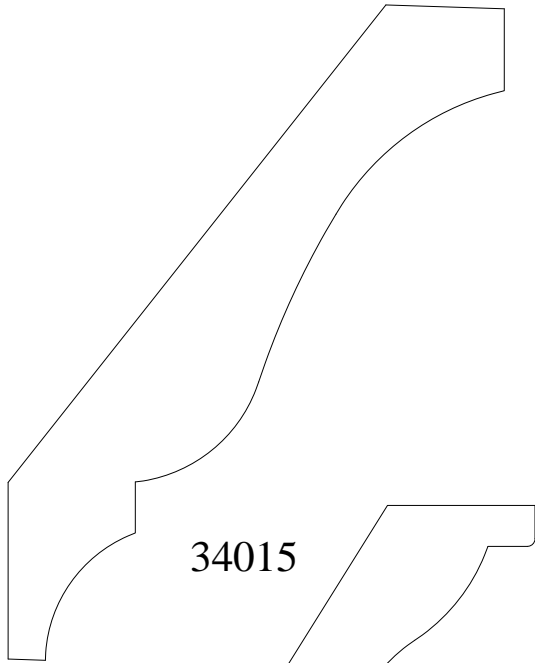

34015

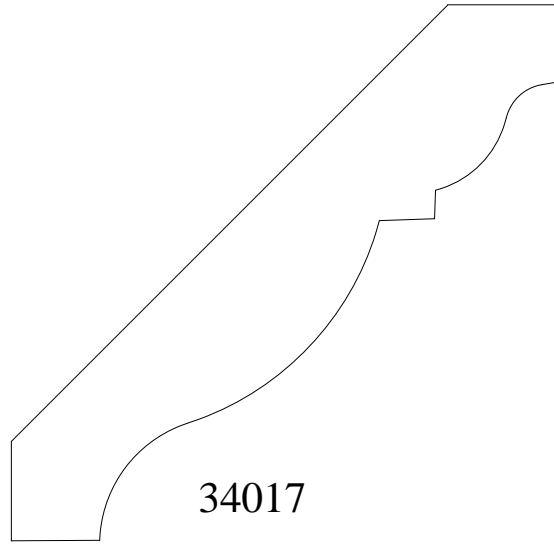

34017

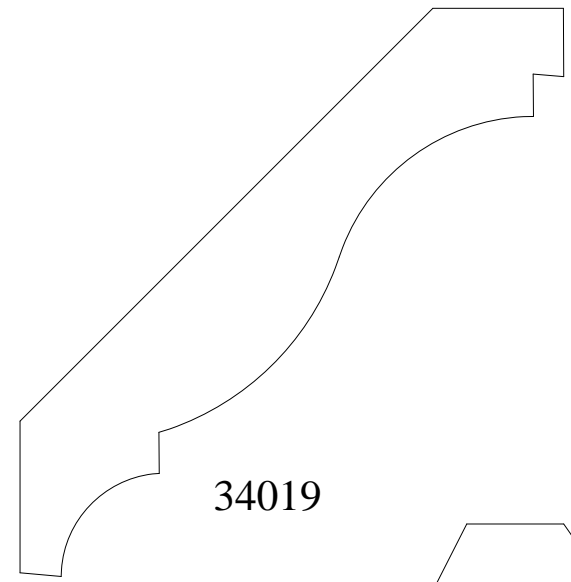

34019

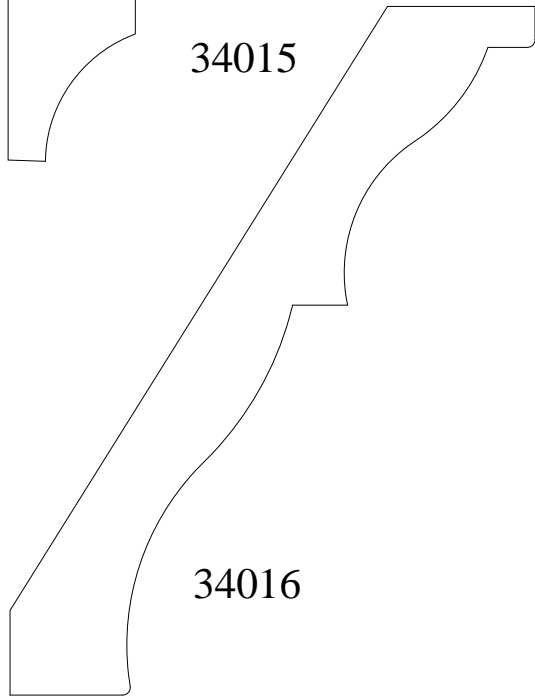

34016

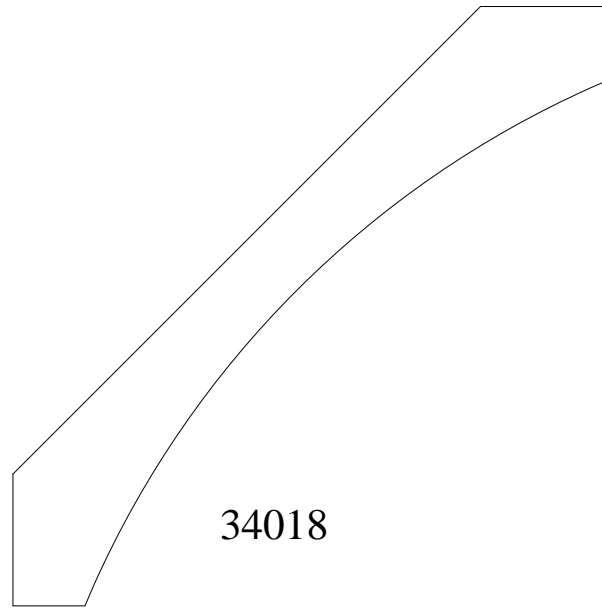

34018

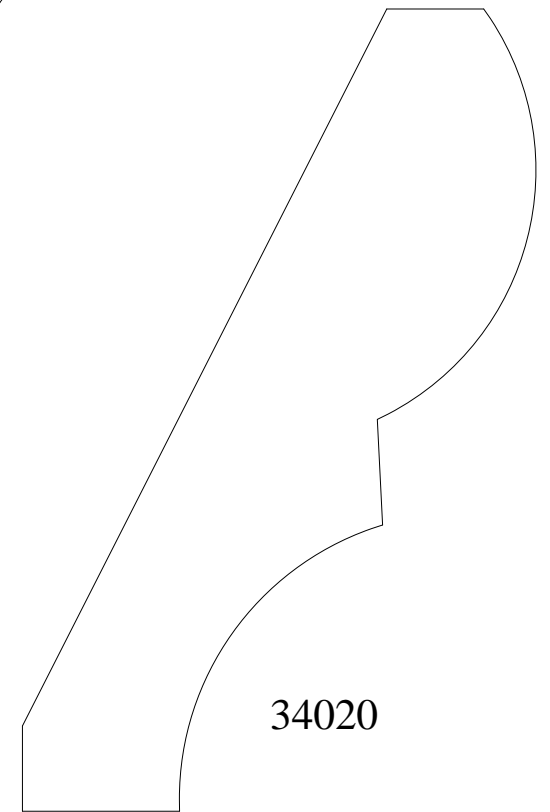

34020

EST. 1879  
**S T A R K**  
L U M B E R C O M P A N Y  
FINE WOOD MOULDING

924 W. 1st. Avenue  
Denver, CO 80223  
303-534-8263 Phone  
303-534-8266 Fax

|              |          |           |             |
|--------------|----------|-----------|-------------|
| Approved by: | MM/DD/YY | Scale 1:1 | Sheet 3-4-3 |
| Drawn:       |          |           |             |
| File name:   |          |           |             |

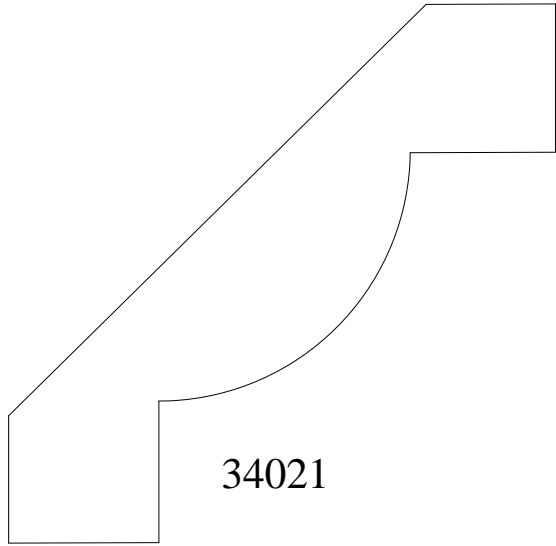

34021

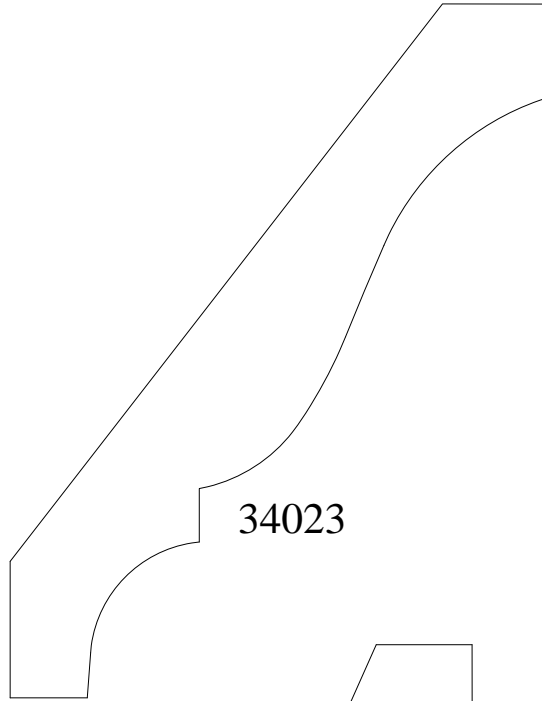

34023

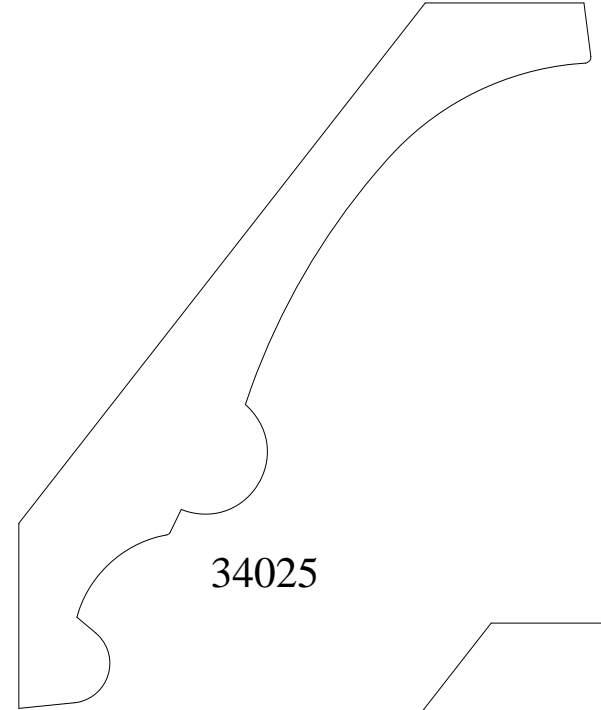

34025

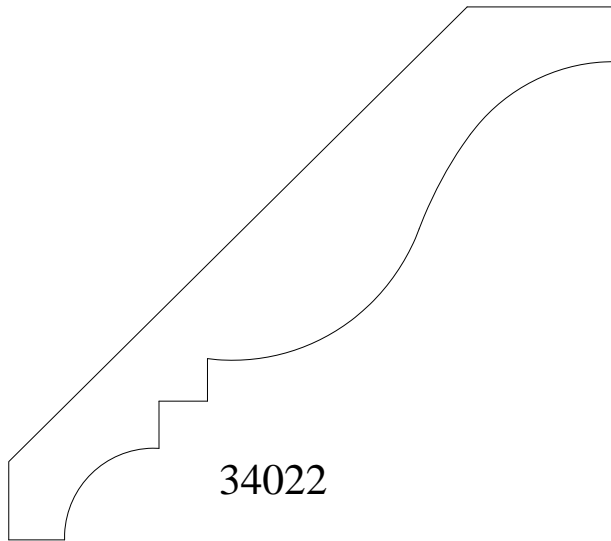

34022

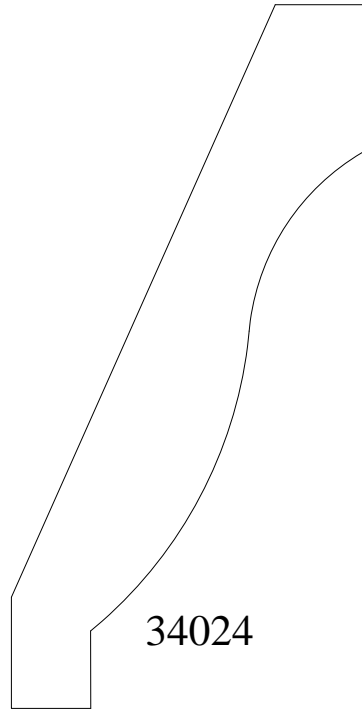

34024

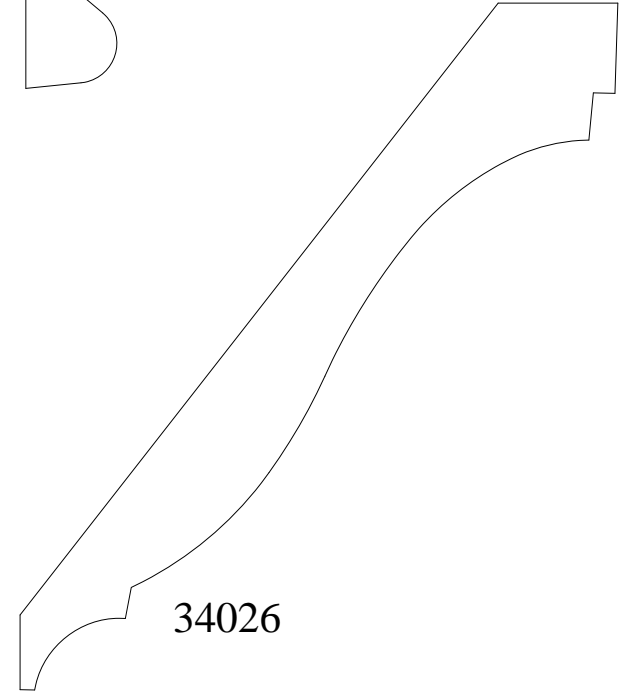

34026

EST. 1879

**S T A R K**

L U M B E R C O M P A N Y

FINE WOOD MOULDING

924 W. 1st. Avenue  
 Denver, CO 80223  
 303-534-8263 Phone  
 303-534-8266 Fax

|              |          |                       |
|--------------|----------|-----------------------|
| Approved by: | MM/DD/YY |                       |
| Drawn:       |          |                       |
| File name:   |          | Scale 1:1 Sheet 3-4-4 |

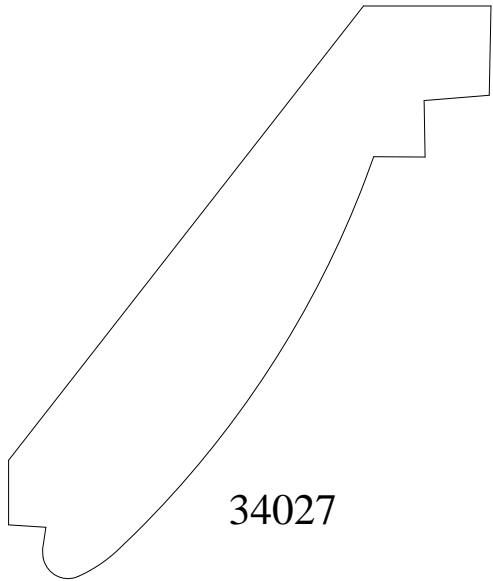

34027

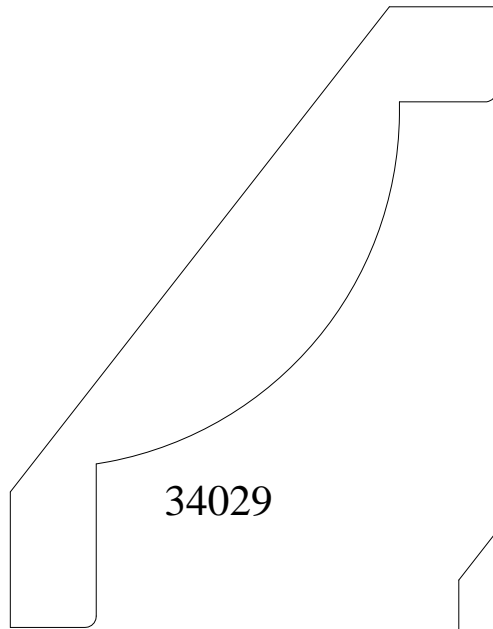

34029

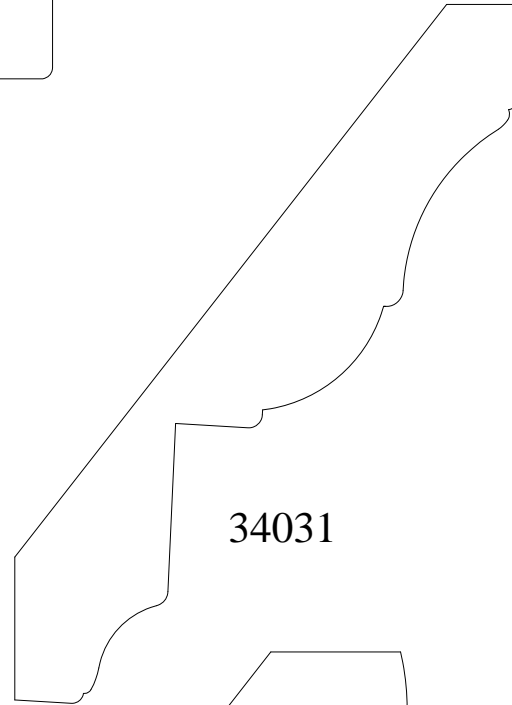

34031

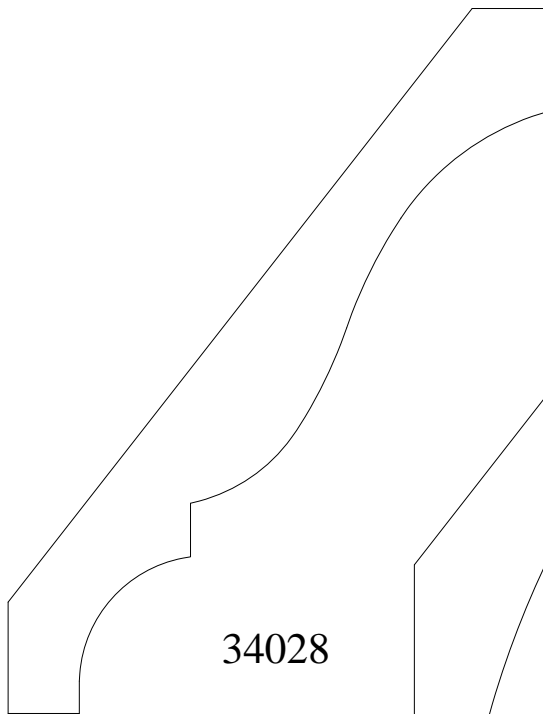

34028

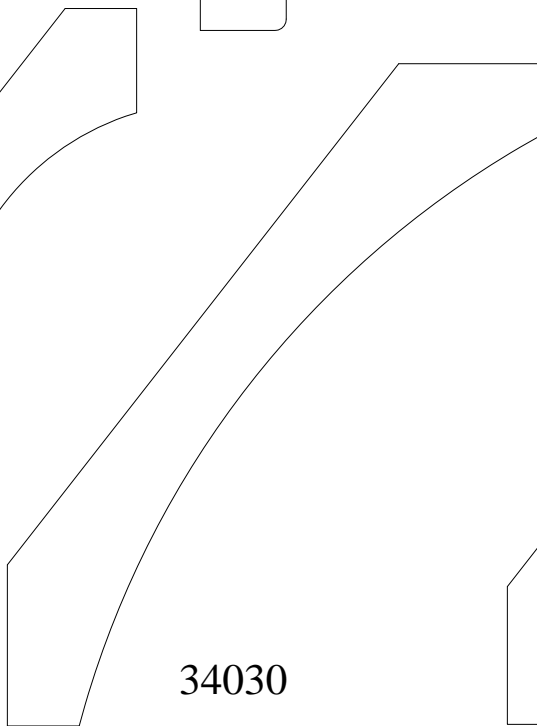

34030

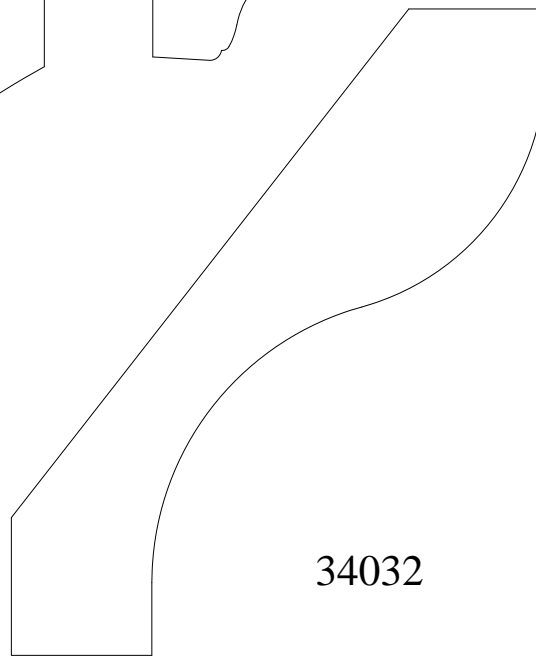

34032

EST. 1879  
**S T A R K**  
L U M B E R C O M P A N Y  
FINE WOOD MOULDING

924 W. 1st. Avenue  
Denver, CO 80223  
303-534-8263 Phone  
303-534-8266 Fax

|              |          |             |
|--------------|----------|-------------|
| Approved by: | MM/DD/YY |             |
| Drawn:       |          |             |
| File name:   |          | Scale 1:1   |
|              |          | Sheet 3-4-5 |

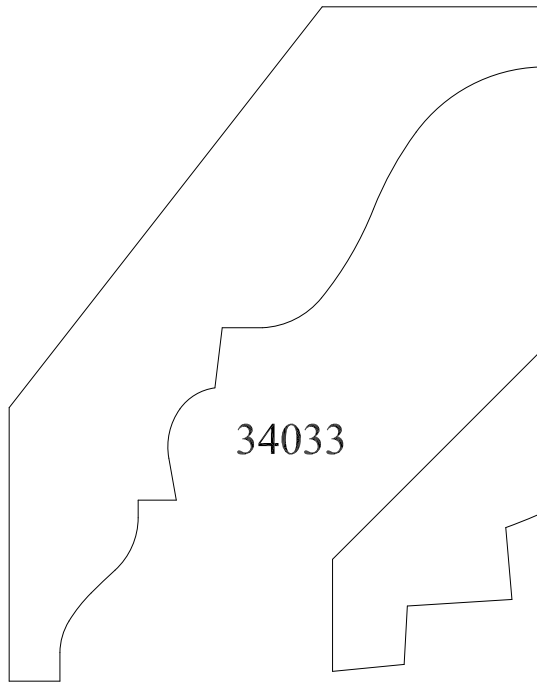

34033

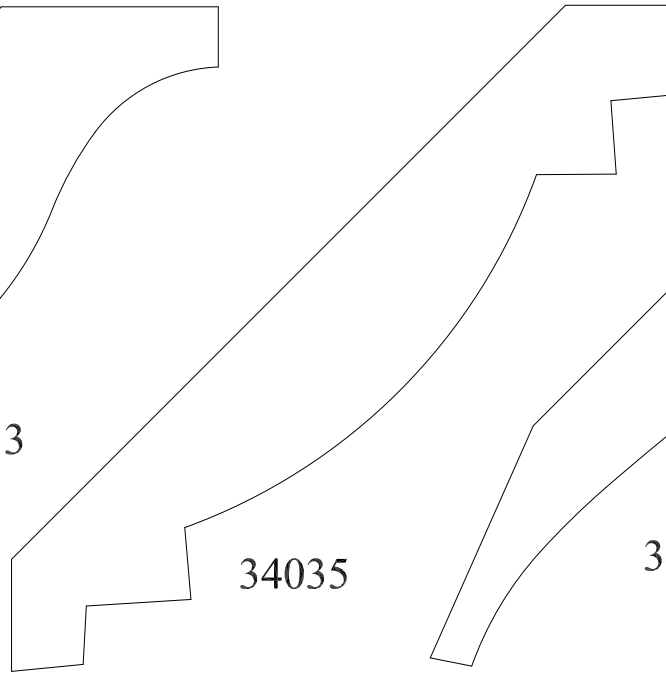

34035



34037

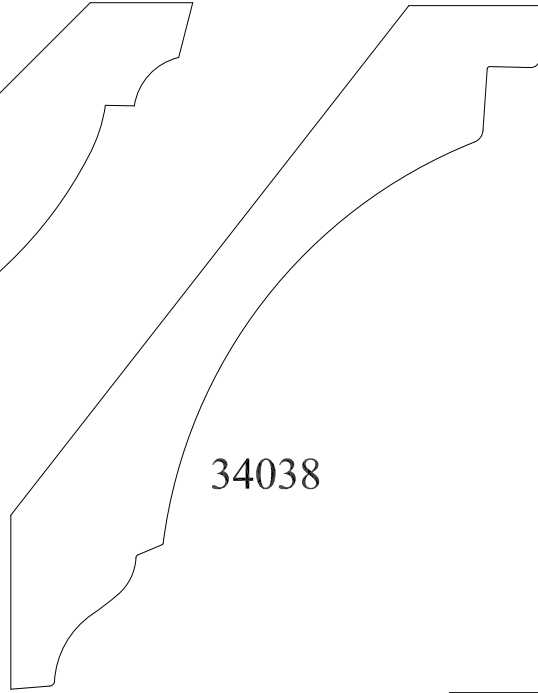

34038

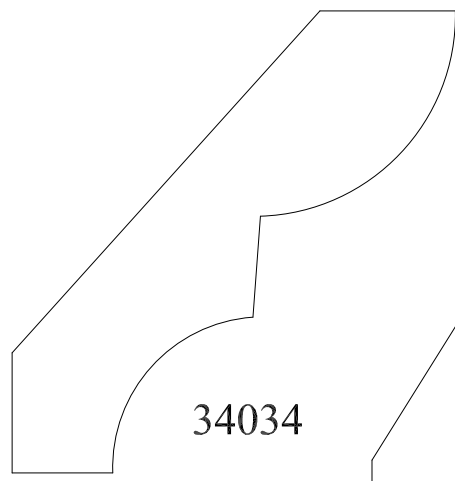

34034

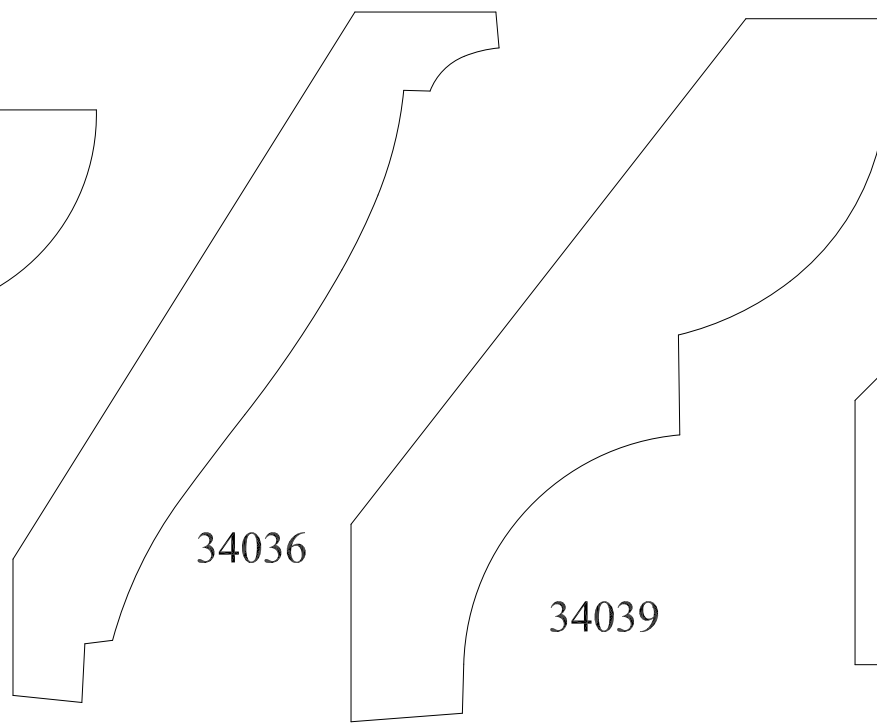

34036

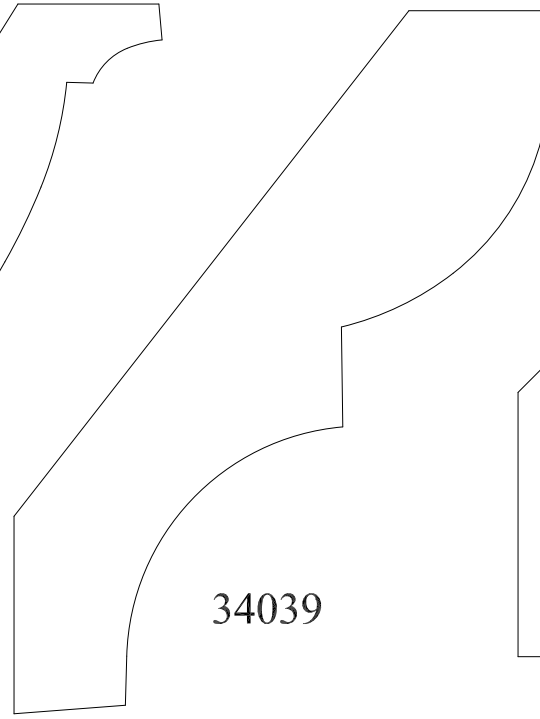

34039

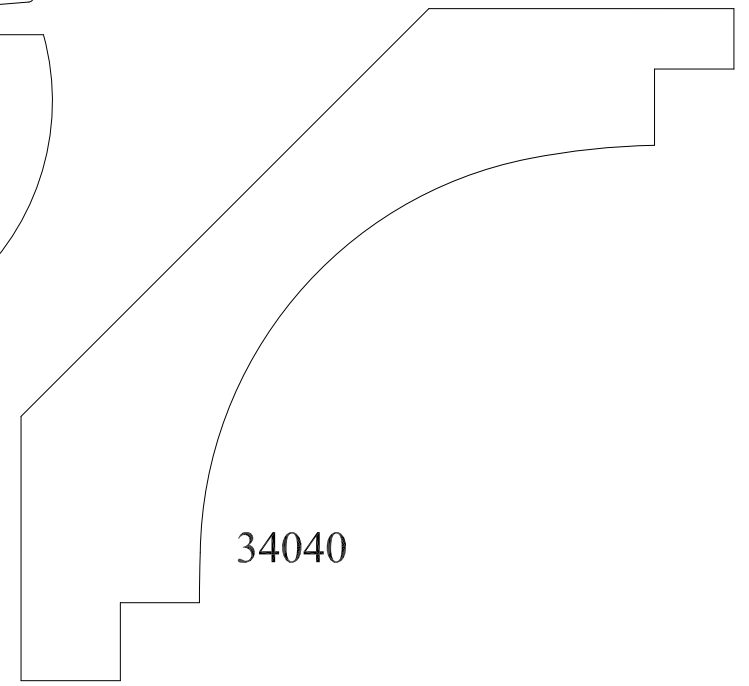

34040

|  |   |
|--|---|
|  <p>EST. 1879<br/>S T A R K<br/>L U M B E R C O M P A N Y<br/>FINE WOOD MOULDING</p> | <p>924 W. 1st. Avenue<br/>Denver, CO 80223<br/>303-534-8263<br/>Phone</p> |
|  | <p>303-534-8266 Fax</p>   |

|  |
|--|
|  |
|--|

|              |          |
|--------------|----------|
| Approved by: | MM/DD/YY |
| Drawn:       |          |
| File name:   |          |

|           |             |
|-----------|-------------|
| Scale 1:1 | Sheet 3-4-6 |
|-----------|-------------|



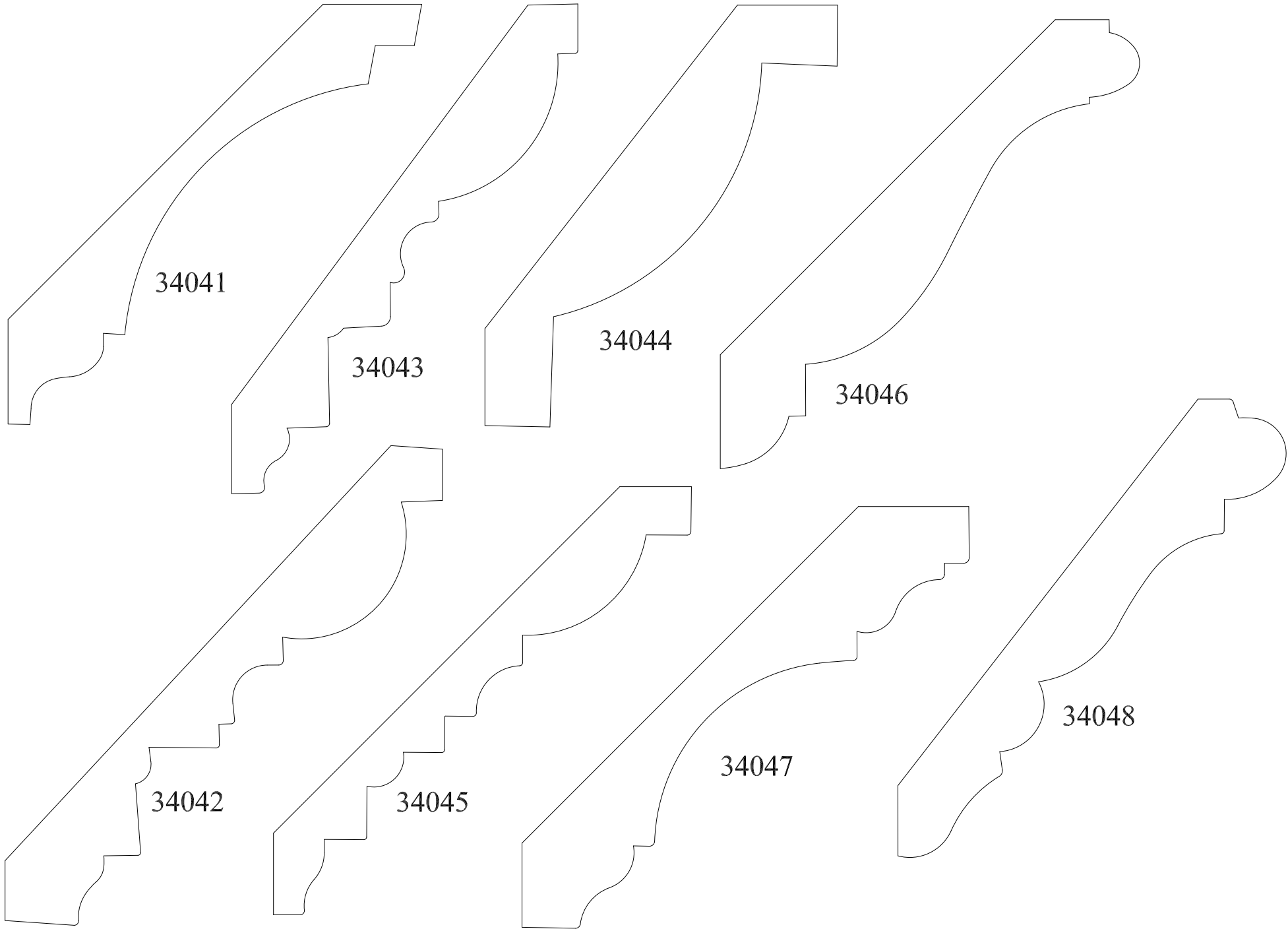

34041

34043

34044

34046

34042

34045

34047

34048

EST. 1879

**S T A R K**  
L U M B E R C O M P A N Y  
FINE WOOD MOULDING

924 W. 1st. Avenue  
Denver, CO 80223  
303-534-8263  
Phone  
303-534-8266 Fax

|  |
|--|
|  |
|  |
|  |

|              |          |
|--------------|----------|
| Approved by: | MM/DD/YY |
| Drawn:       |          |
| File name:   |          |

|           |             |
|-----------|-------------|
| Scale 1:1 | Sheet 3-4-7 |
|-----------|-------------|

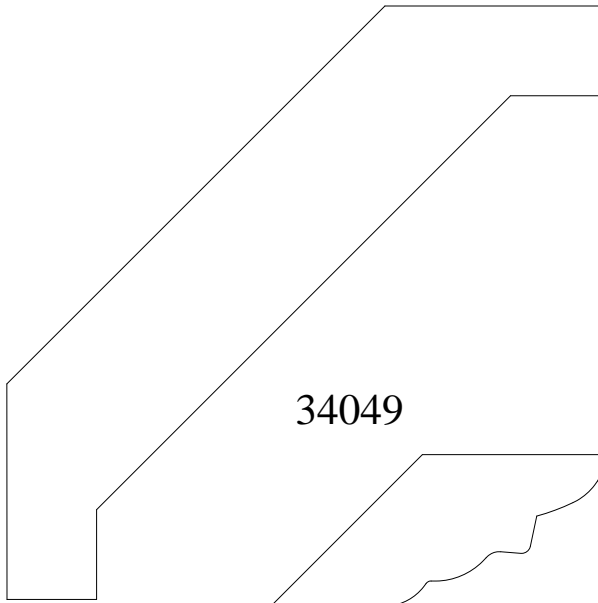

34049

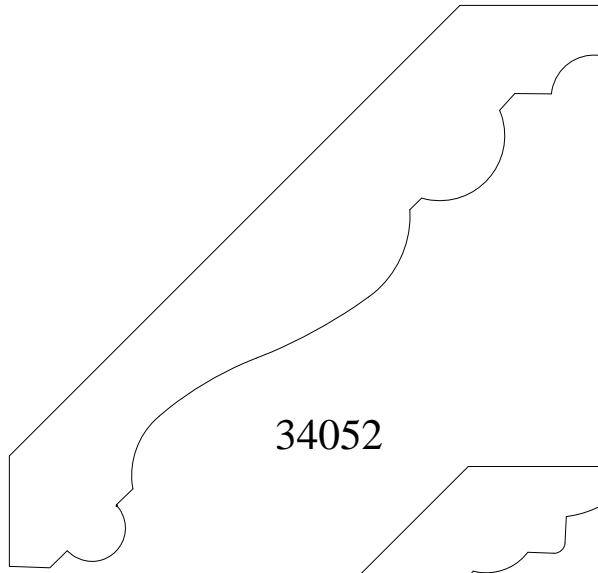

34052

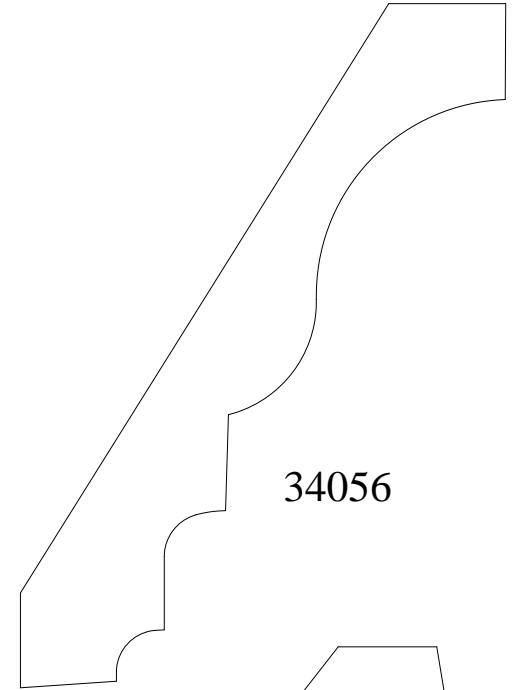

34056

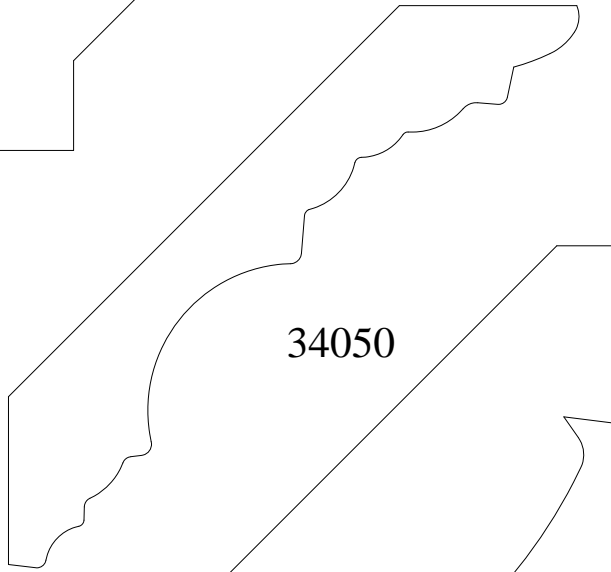

34050



34053

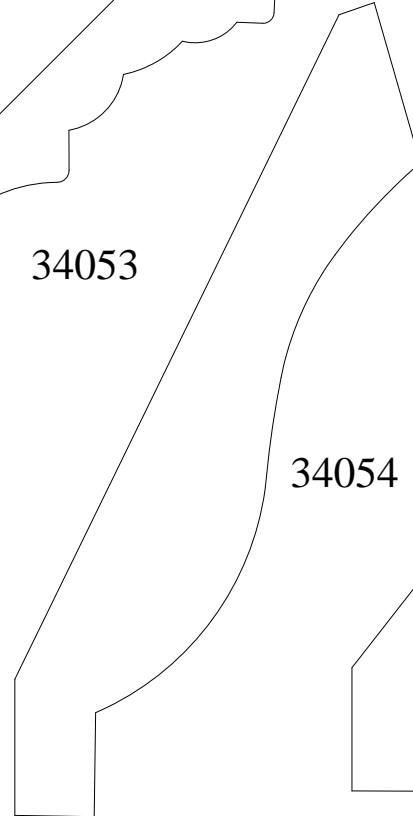

34054

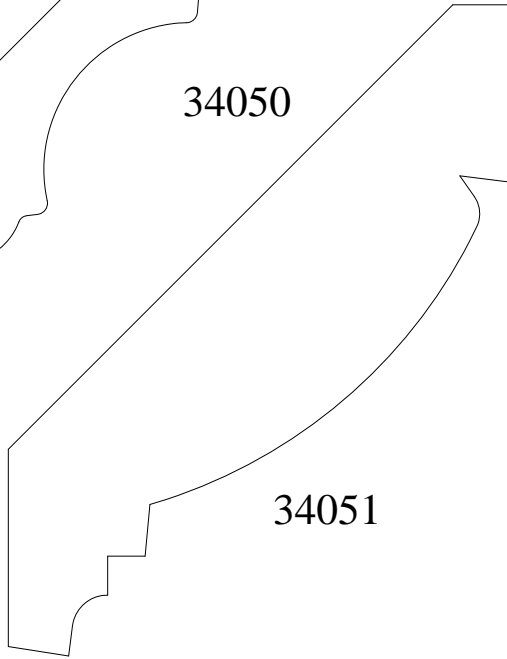

34051



34055

EST. 1879

**S T A R K**

L U M B E R C O M P A N Y

FINE WOOD MOULDING

924 W. 1st. Avenue  
 Denver, CO 80223  
 303-534-8263 Phone  
 303-534-8266 Fax

|              |          |                       |
|--------------|----------|-----------------------|
| Approved by: | MM/DD/YY |                       |
| Drawn:       |          |                       |
| File name:   |          | Scale 1:1 Sheet 3-4-8 |

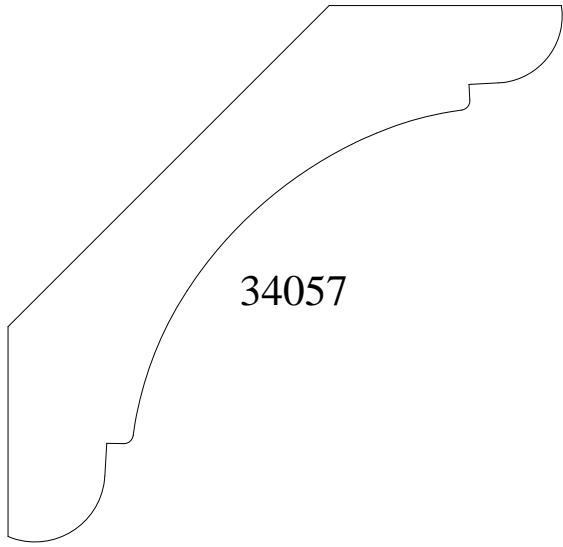

34057

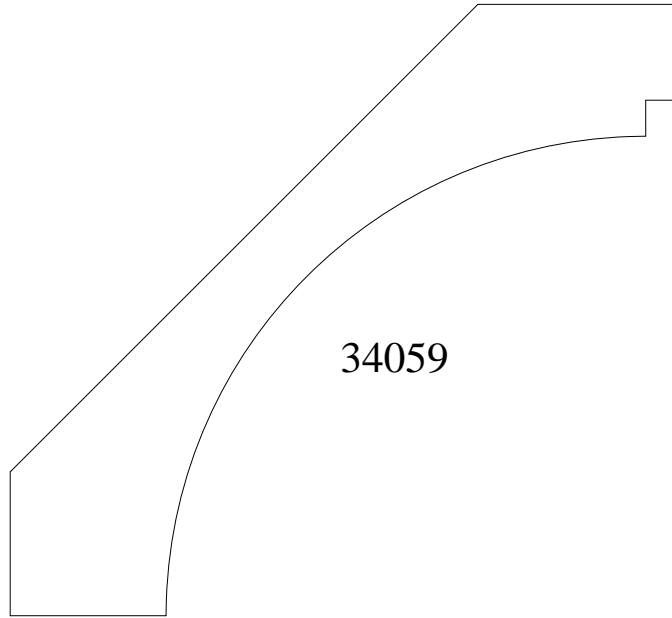

34059

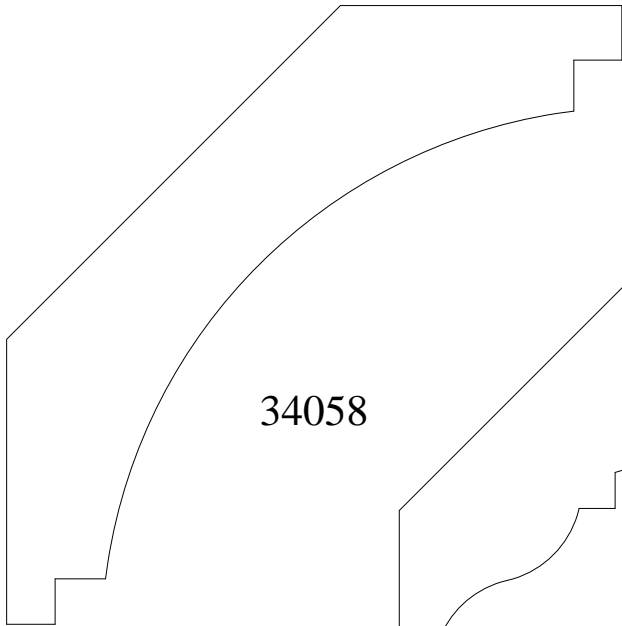

34058

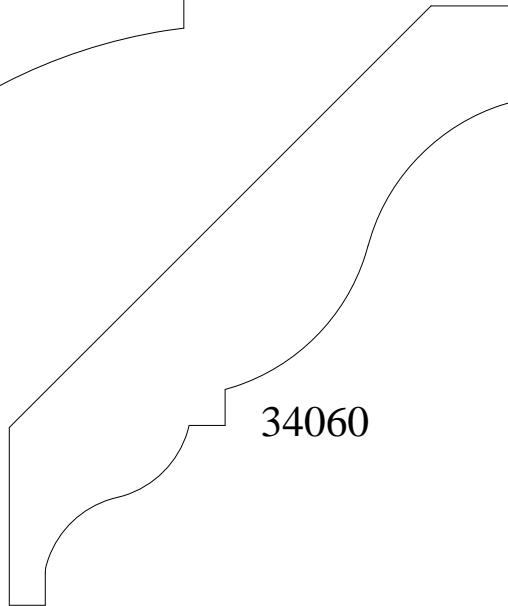

34060

EST. 1879  
**S T A R K**  
L U M B E R C O M P A N Y  
FINE WOOD MOULDING

924 W. 1st. Avenue  
Denver, CO 80223  
303-534-8263 Phone  
303-534-8266 Fax

|              |          |                       |
|--------------|----------|-----------------------|
| Approved by: | MM/DD/YY |                       |
| Drawn:       |          |                       |
| File name:   |          | Scale 1:1 Sheet 3-4-9 |



35001

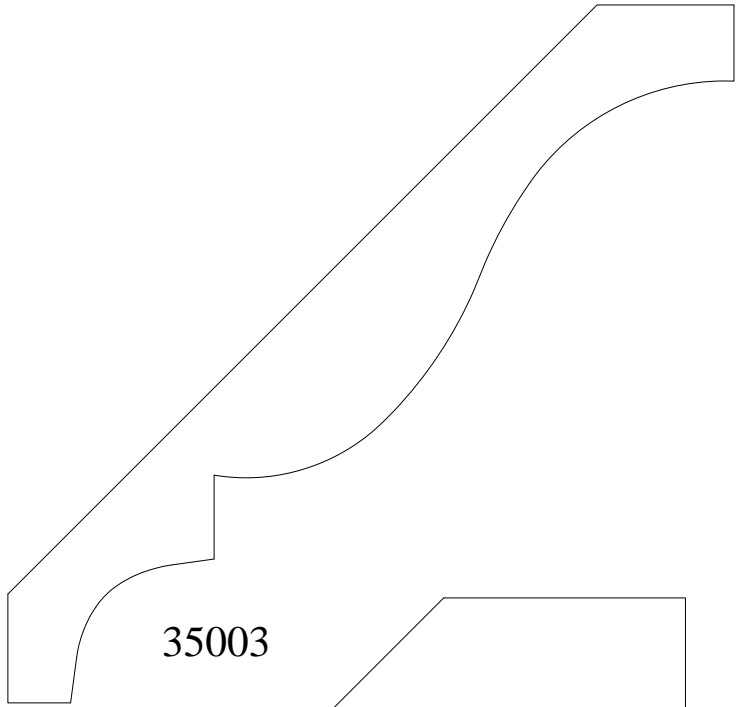

35003

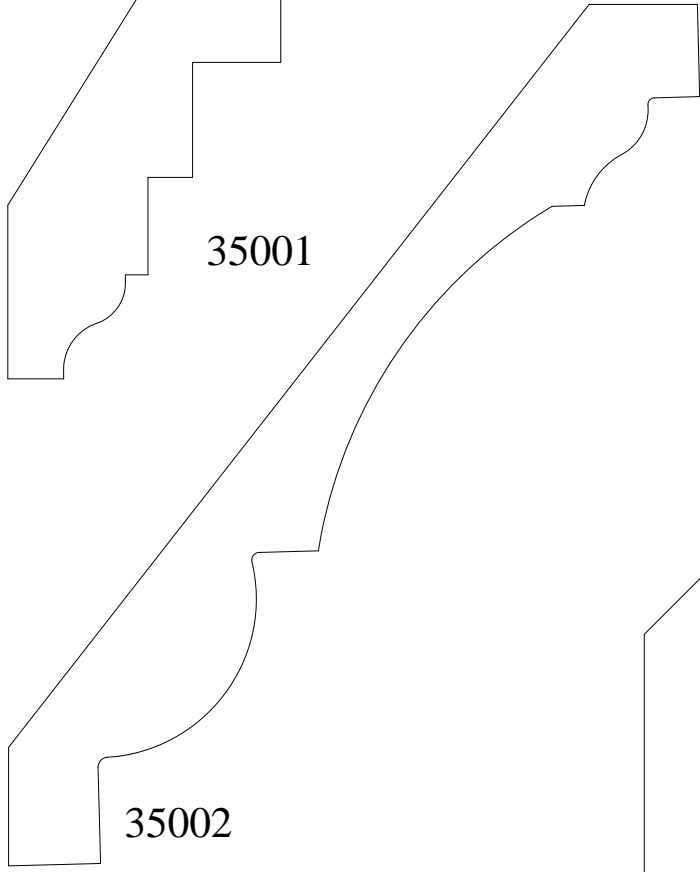

35002

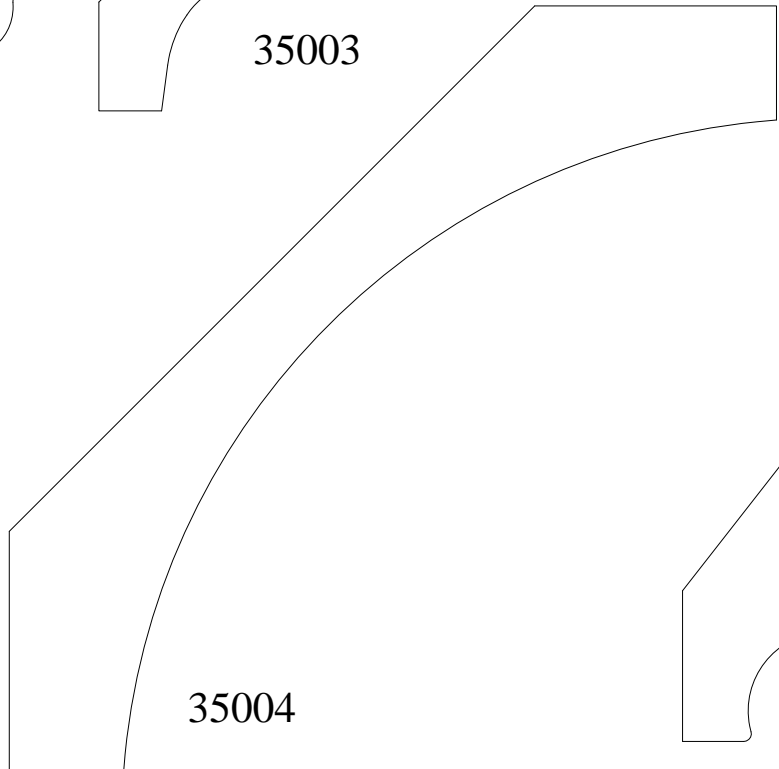

35004

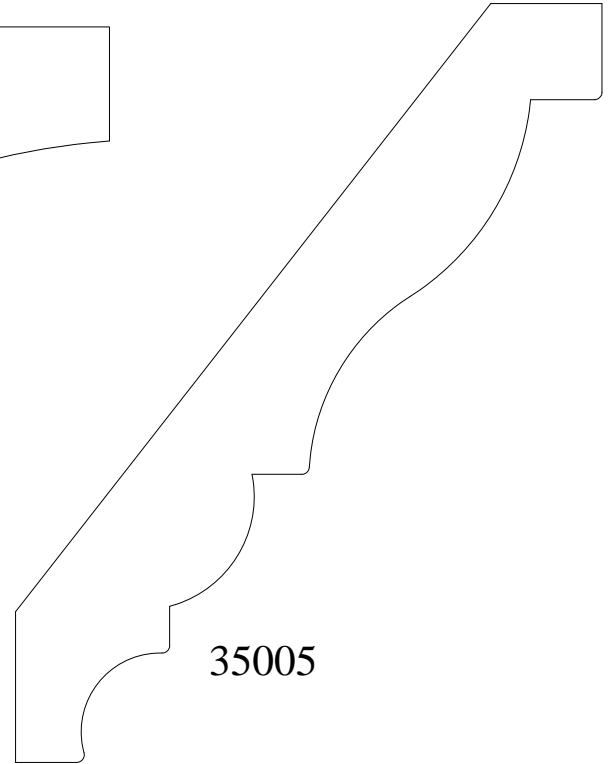

35005

EST. 1879

**S T A R K**

L U M B E R C O M P A N Y

FINE WOOD MOULDING

924 W. 1st. Avenue  
 Denver, CO 80223  
 303-534-8263 Phone  
 303-534-8266 Fax

|              |          |             |
|--------------|----------|-------------|
| Approved by: | MM/DD/YY |             |
| Drawn:       |          |             |
| File name:   |          | Scale 1:1   |
|              |          | Sheet 3-5-1 |

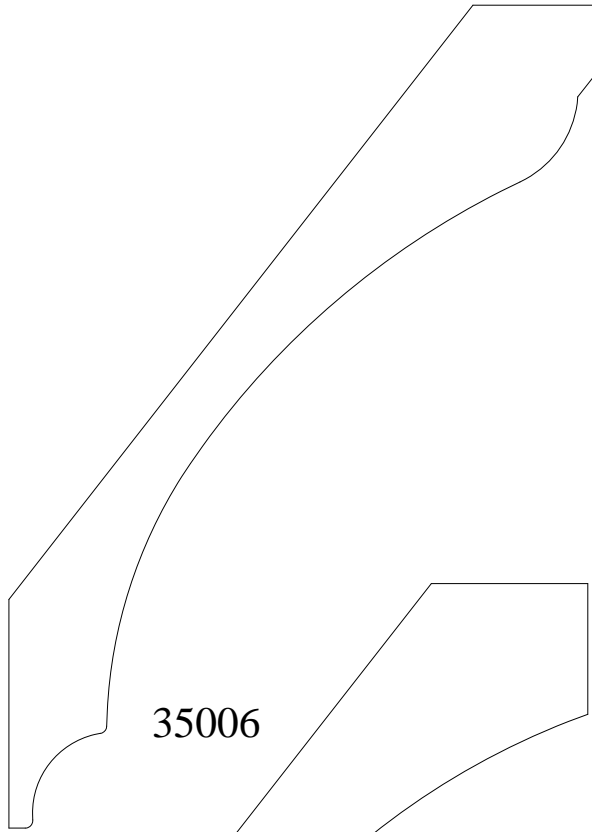

35006

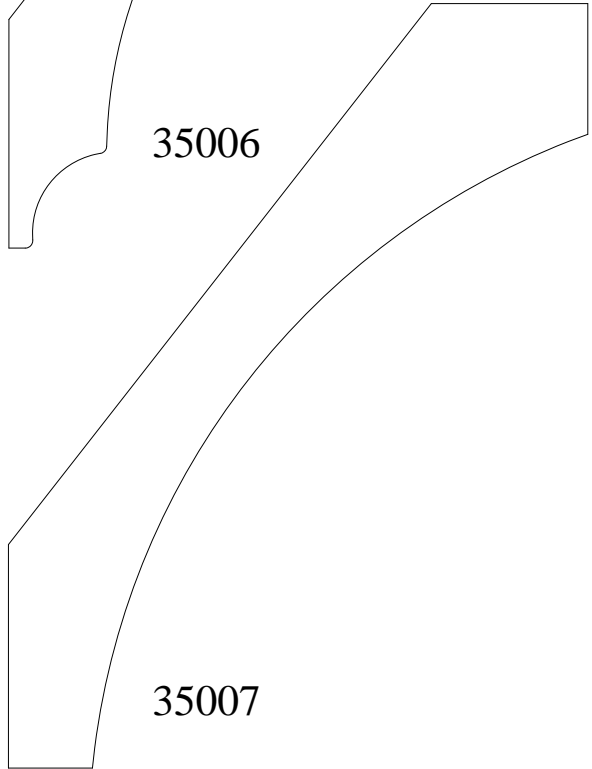

35007

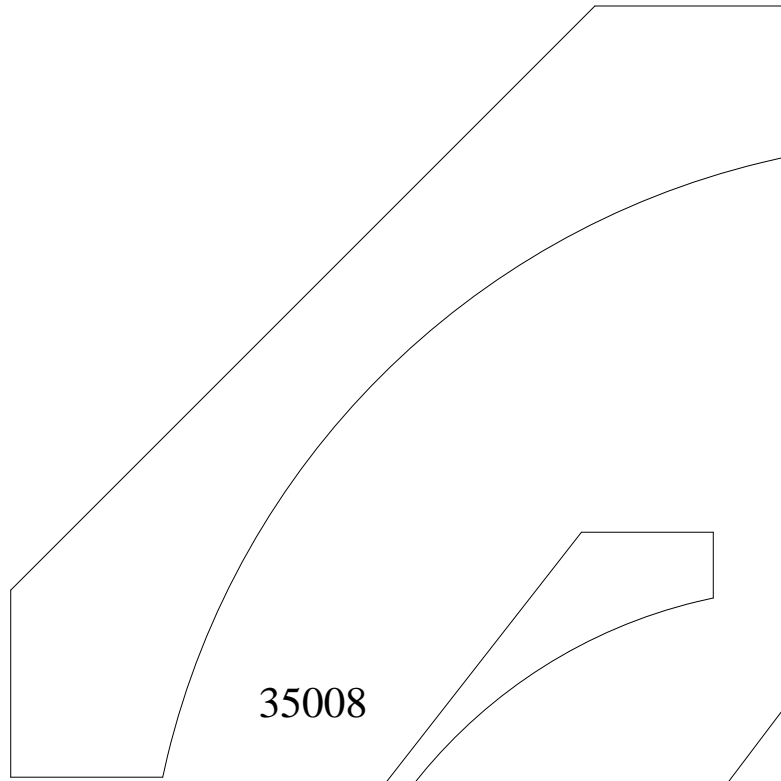

35008

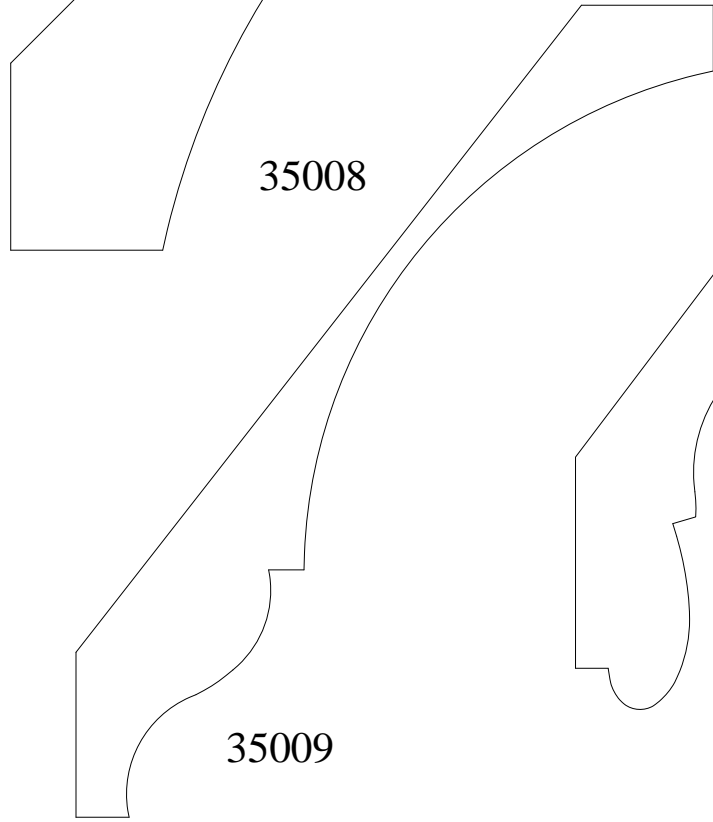

35009

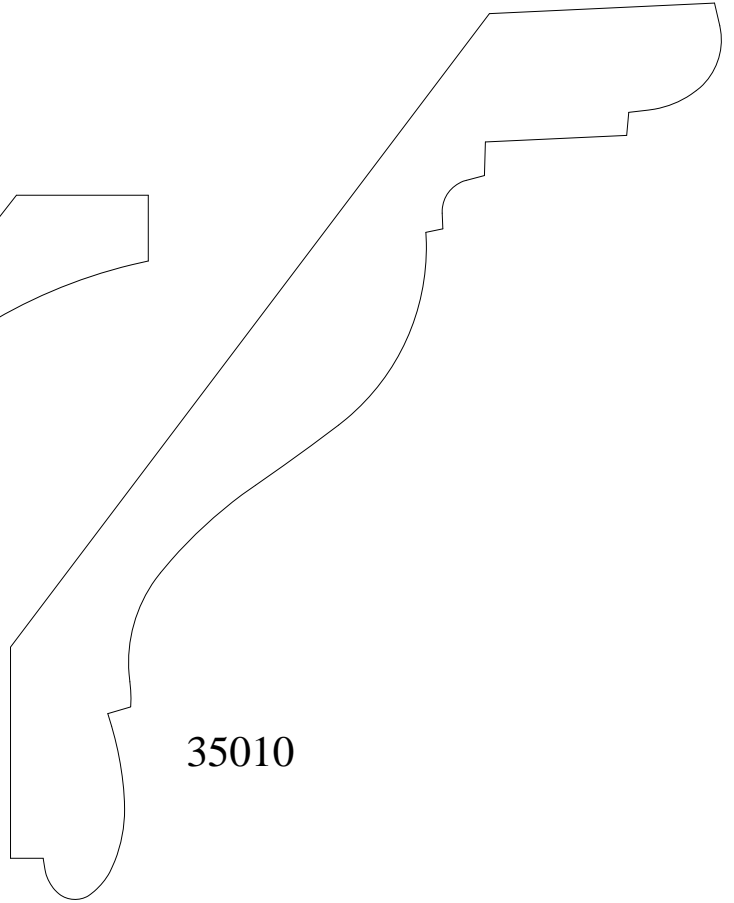

35010

EST. 1879

**S T A R K**

L U M B E R C O M P A N Y

FINE WOOD MOULDING

924 W. 1st. Avenue  
 Denver, CO 80223  
 303-534-8263 Phone  
 303-534-8266 Fax

|              |          |             |
|--------------|----------|-------------|
| Approved by: | MM/DD/YY |             |
| Drawn:       |          |             |
| File name:   |          | Scale 1:1   |
|              |          | Sheet 3-5-2 |

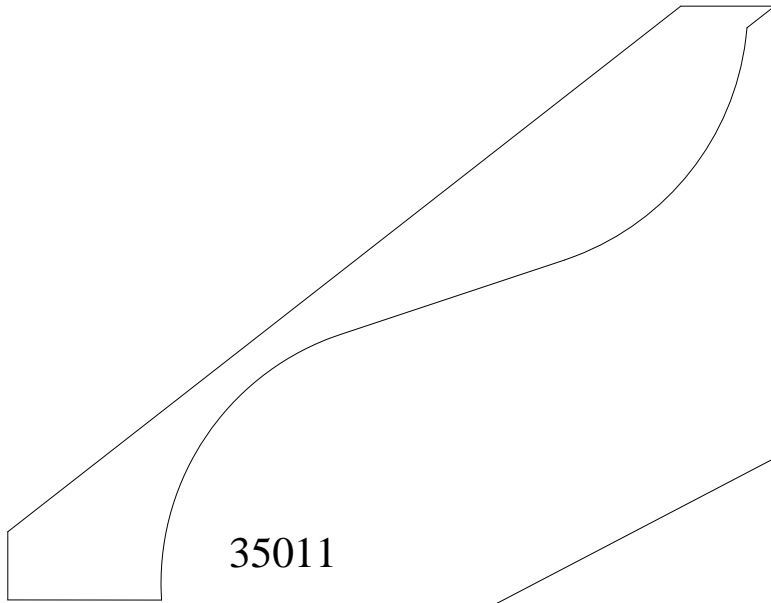

35011

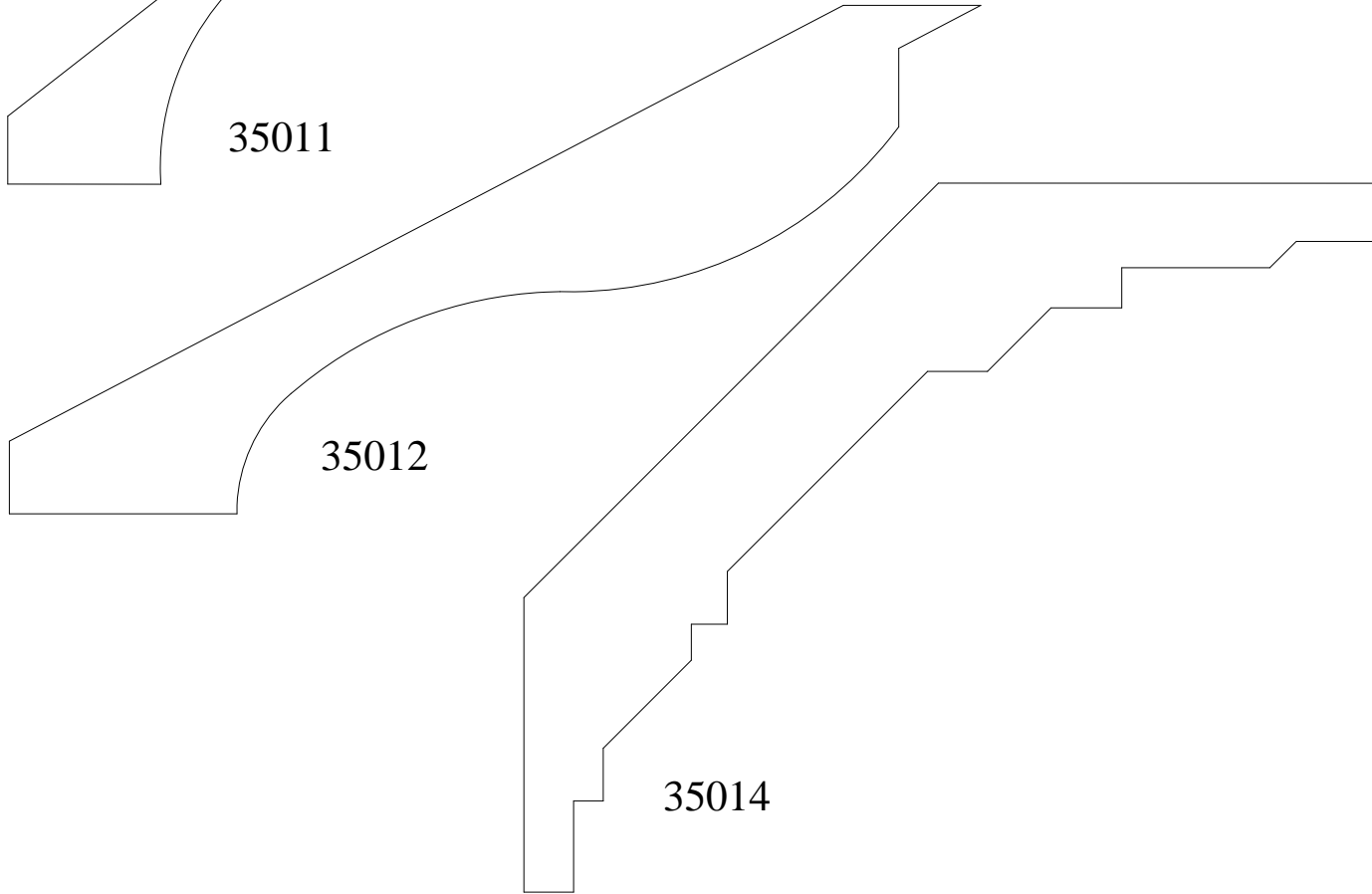

35012

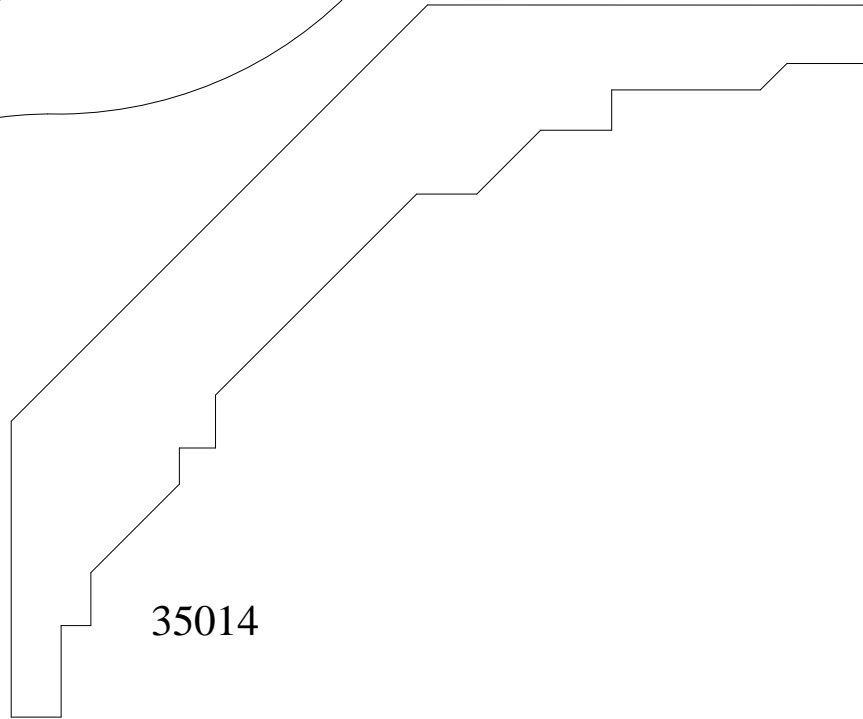

35014

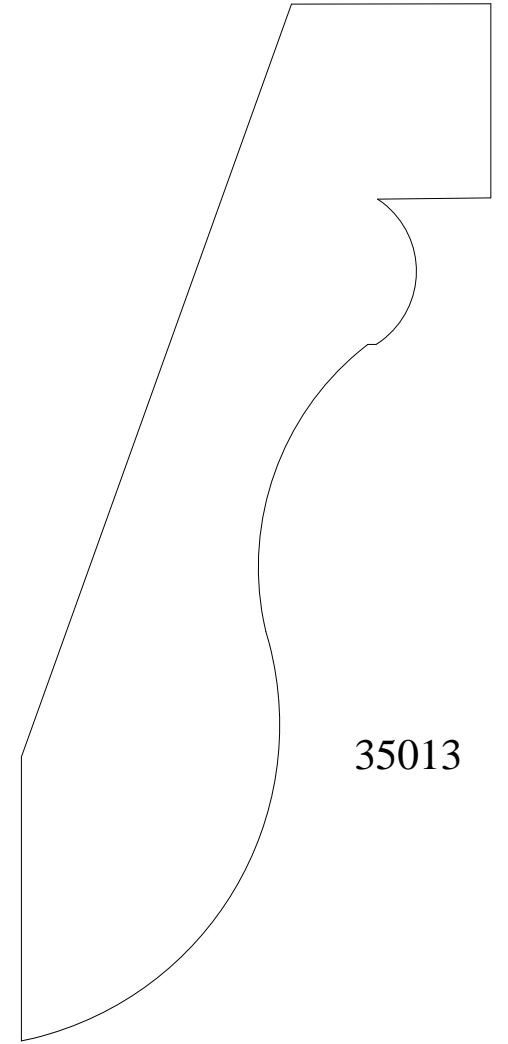

35013



924 W. 1st. Avenue  
Denver, CO 80223  
303-534-8263 Phone  
303-534-8266 Fax

|              |          |             |
|--------------|----------|-------------|
| Approved by: | MM/DD/YY |             |
| Drawn:       |          |             |
| File name:   |          | Scale 1:1   |
|              |          | Sheet 3-5-3 |

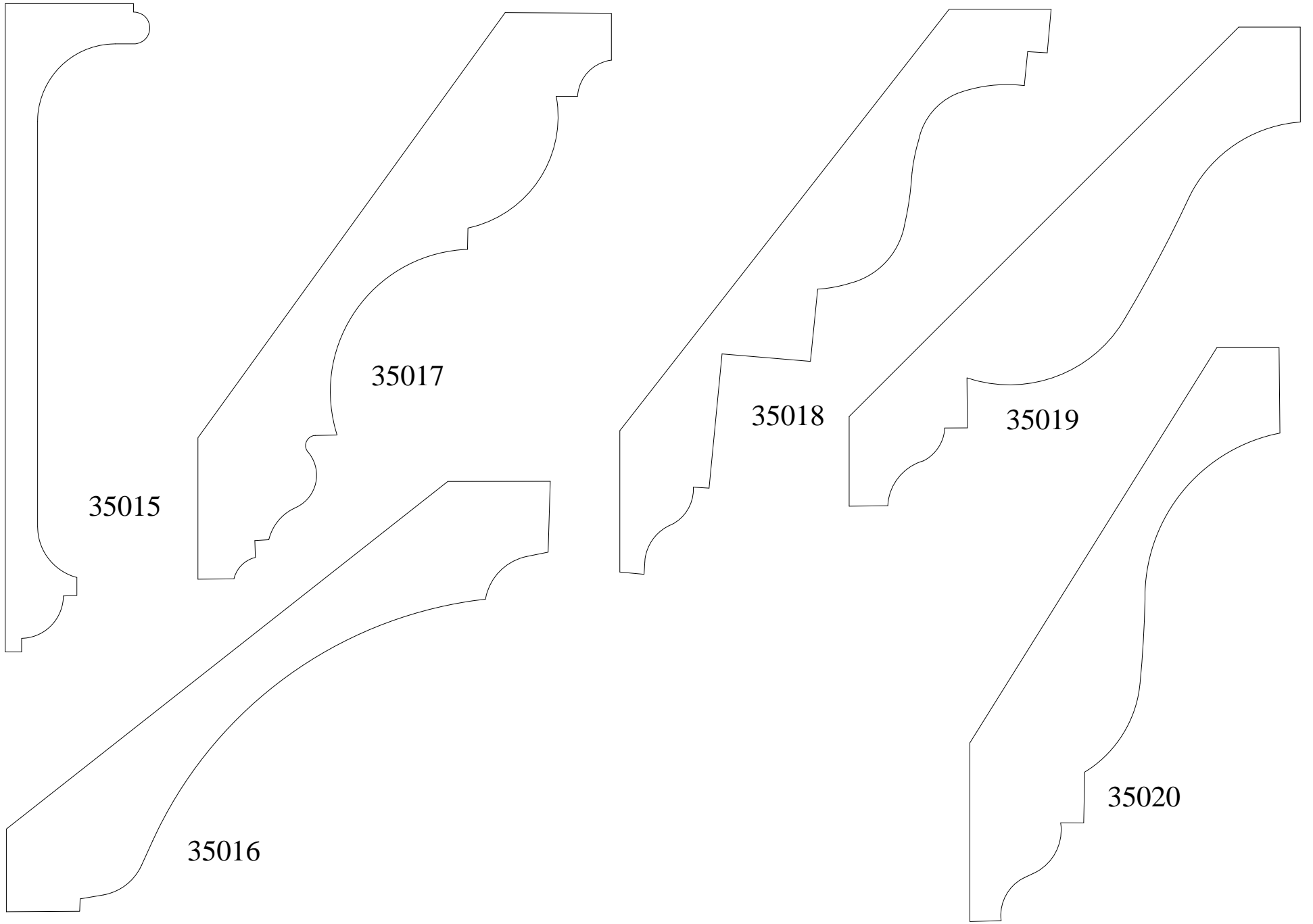

EST. 1879

**S T A R K**

L U M B E R C O M P A N Y

FINE WOOD MOULDING

924 W. 1st. Avenue  
 Denver, CO 80223  
 303-534-8263 Phone  
 303-534-8266 Fax

|              |          |
|--------------|----------|
| Approved by: | MM/DD/YY |
| Drawn:       |          |
| File name:   |          |

Scale 1:1

Sheet 3-5-4



35021



35023

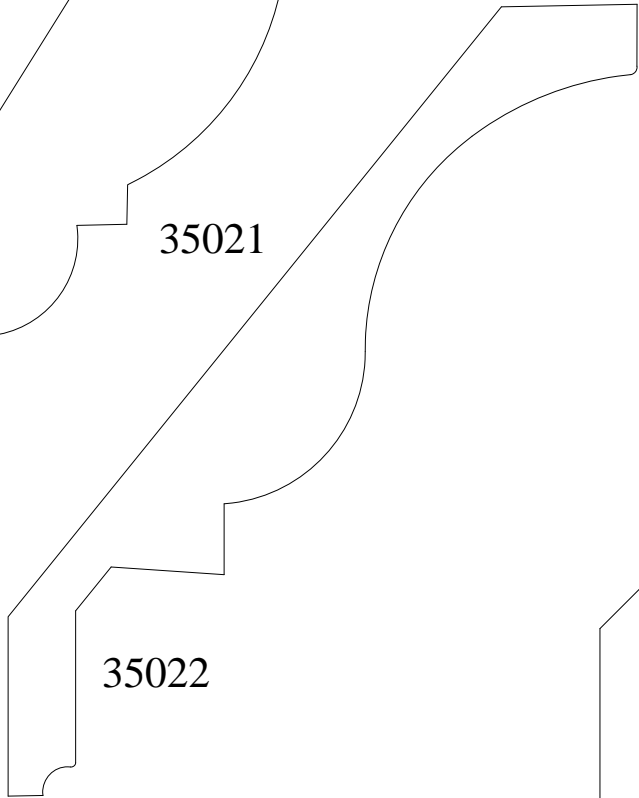

35022

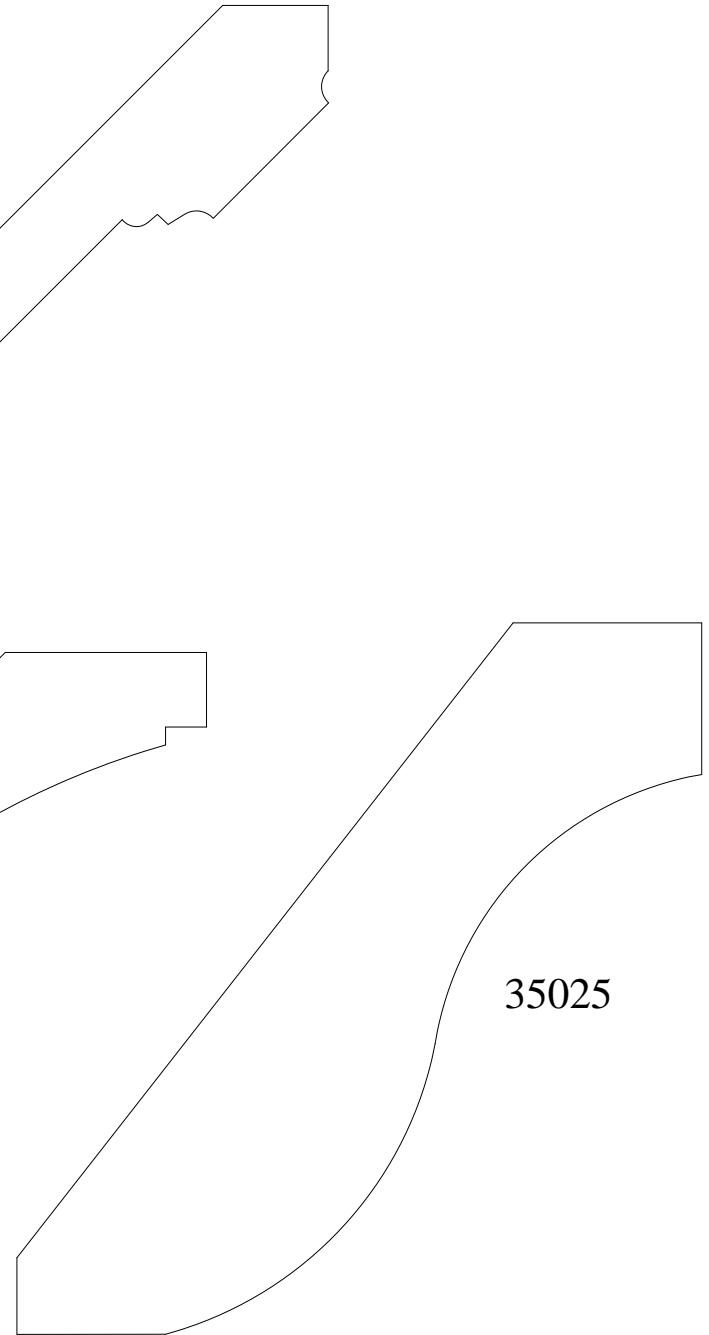

35025

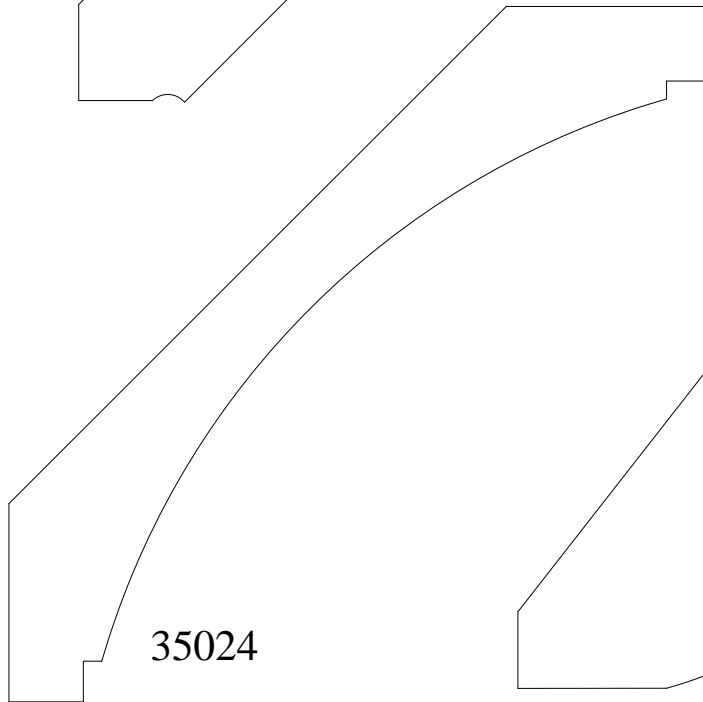

35024

EST. 1879

**S T A R K**

L U M B E R C O M P A N Y

FINE WOOD MOULDING

924 W. 1st. Avenue  
 Denver, CO 80223  
 303-534-8263 Phone  
 303-534-8266 Fax

|              |          |             |
|--------------|----------|-------------|
| Approved by: | MM/DD/YY |             |
| Drawn:       |          |             |
| File name:   |          | Scale 1:1   |
|              |          | Sheet 3-5-5 |



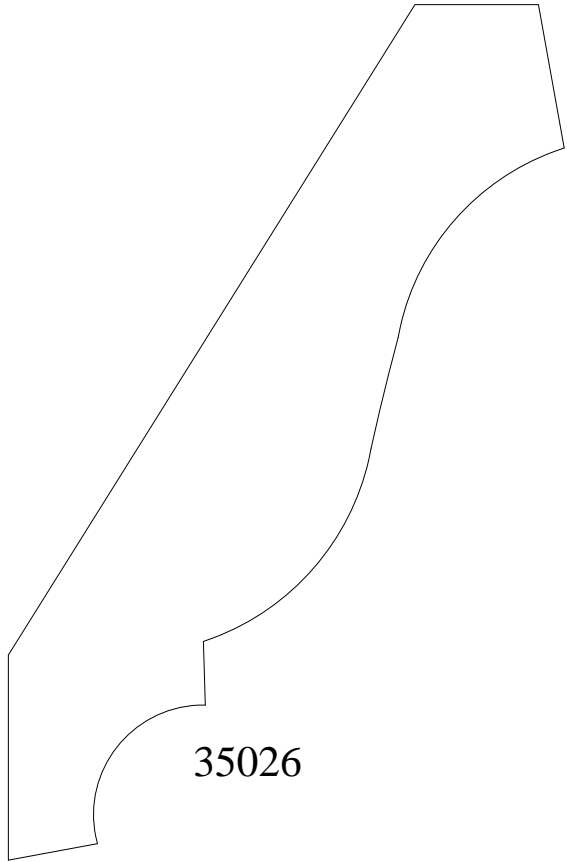

35026



35027

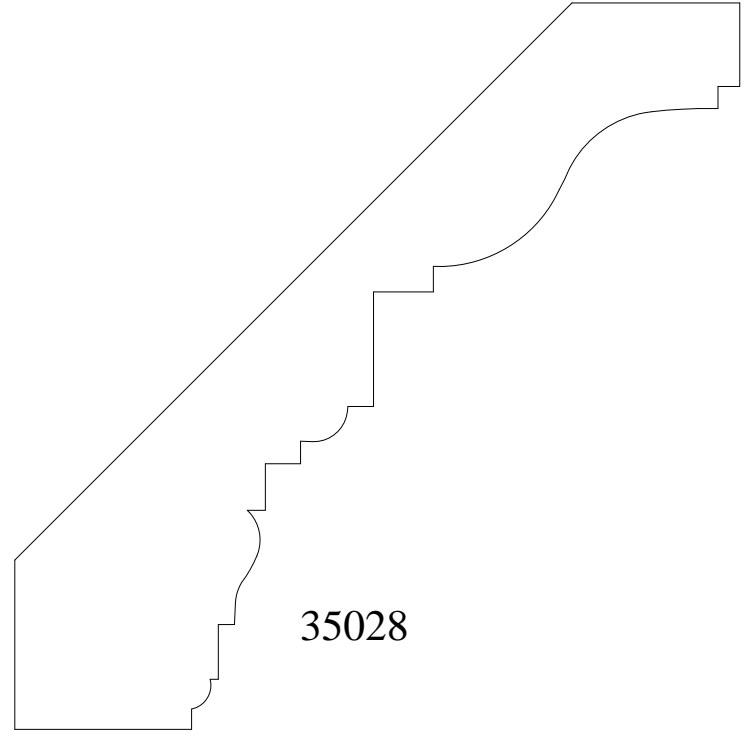

35028

EST. 1879

**S T A R K**

L U M B E R C O M P A N Y

FINE WOOD MOULDING

924 W. 1st. Avenue  
 Denver, CO 80223  
 303-534-8263 Phone  
 303-534-8266 Fax

|              |          |                       |
|--------------|----------|-----------------------|
| Approved by: | MM/DD/YY |                       |
| Drawn:       |          |                       |
| File name:   |          | Scale 1:1 Sheet 3-5-6 |

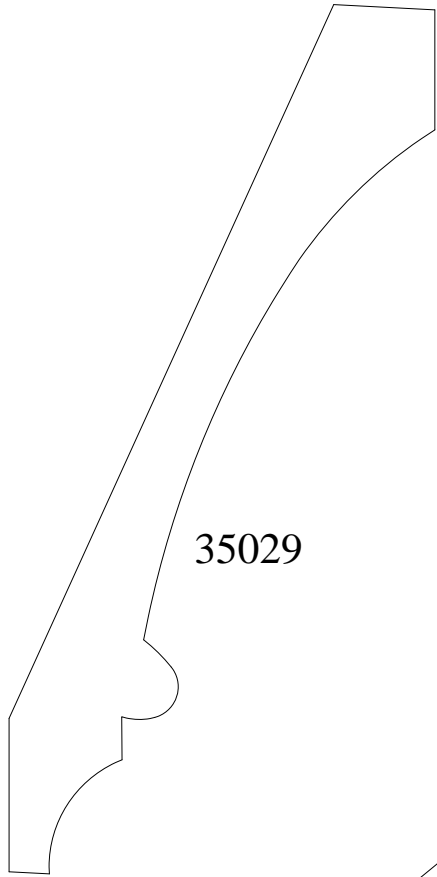

35029

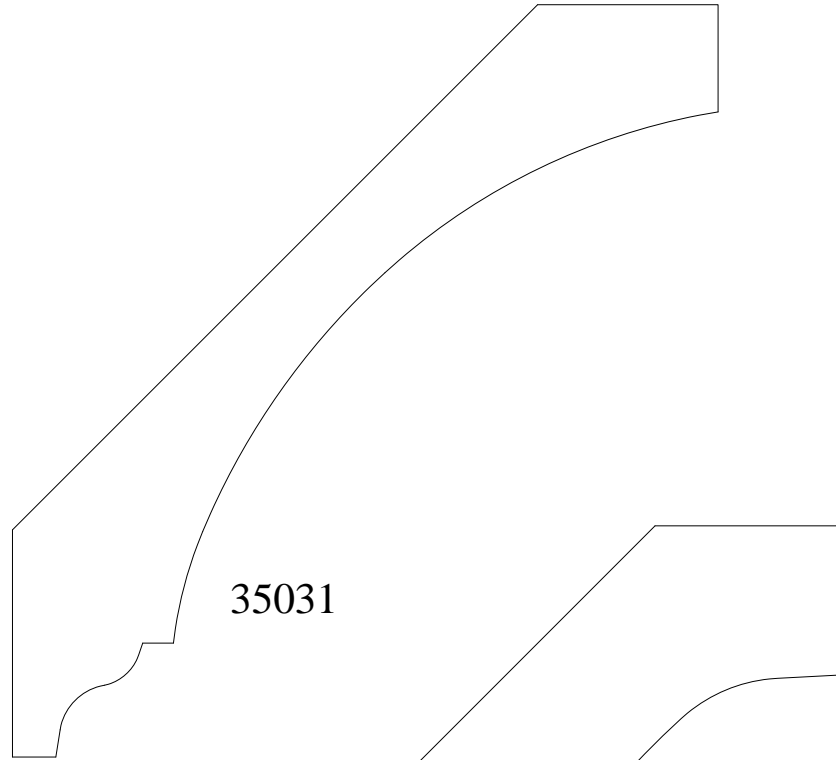

35031



35030



35032

EST. 1879  
**S T A R K**  
L U M B E R C O M P A N Y  
FINE WOOD MOULDING

924 W. 1st. Avenue  
Denver, CO 80223  
303-534-8263 Phone  
303-534-8266 Fax

|              |          |             |
|--------------|----------|-------------|
| Approved by: | MM/DD/YY |             |
| Drawn:       |          |             |
| File name:   |          | Scale 1:1   |
|              |          | Sheet 3-5-7 |

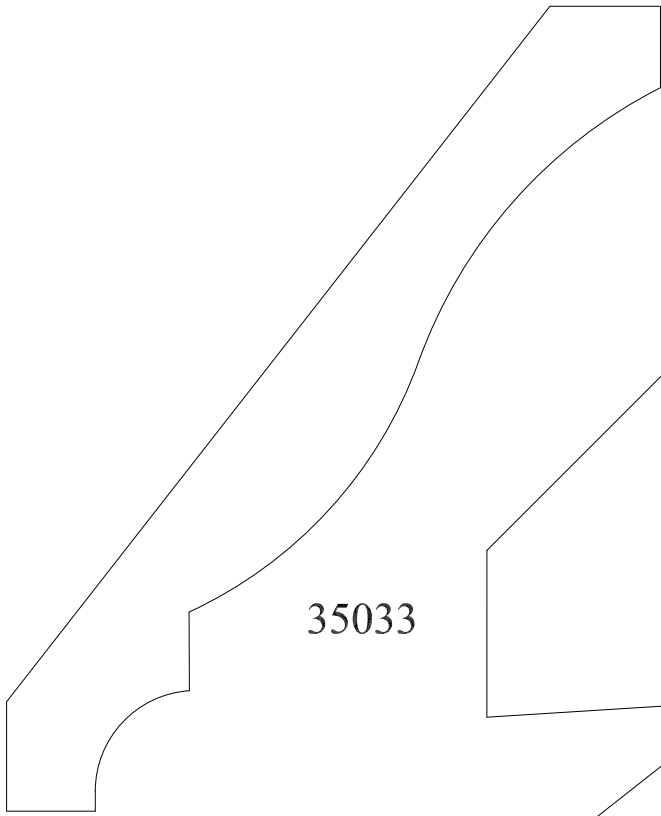

35033

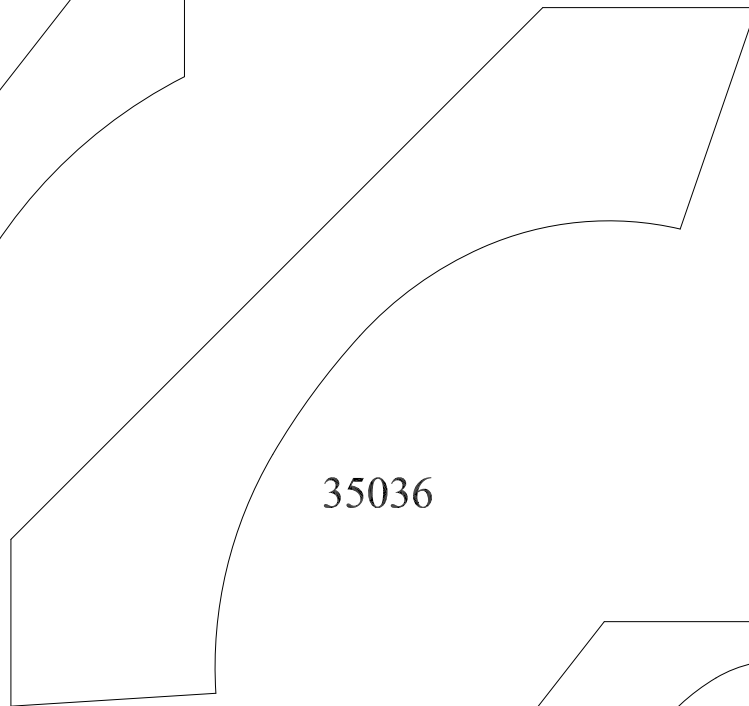

35036

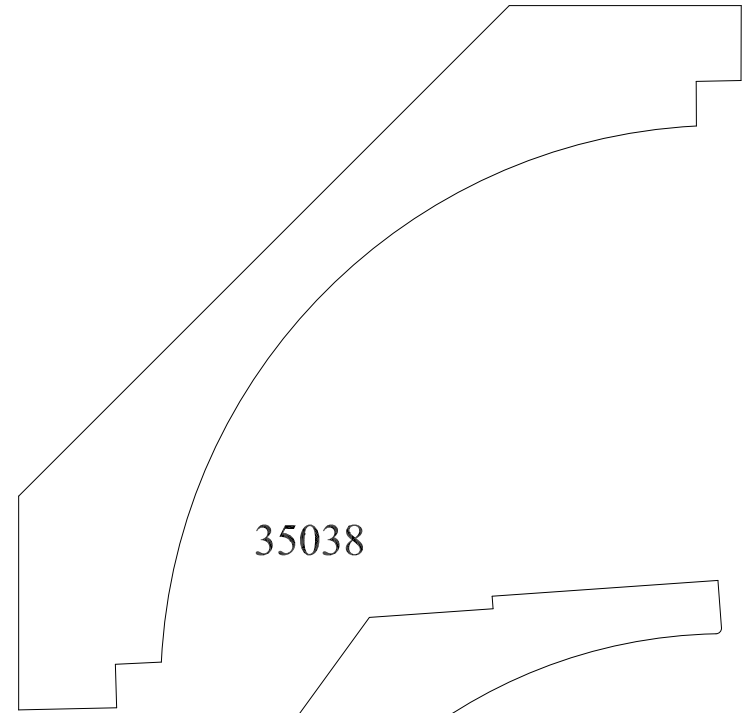

35038



35034

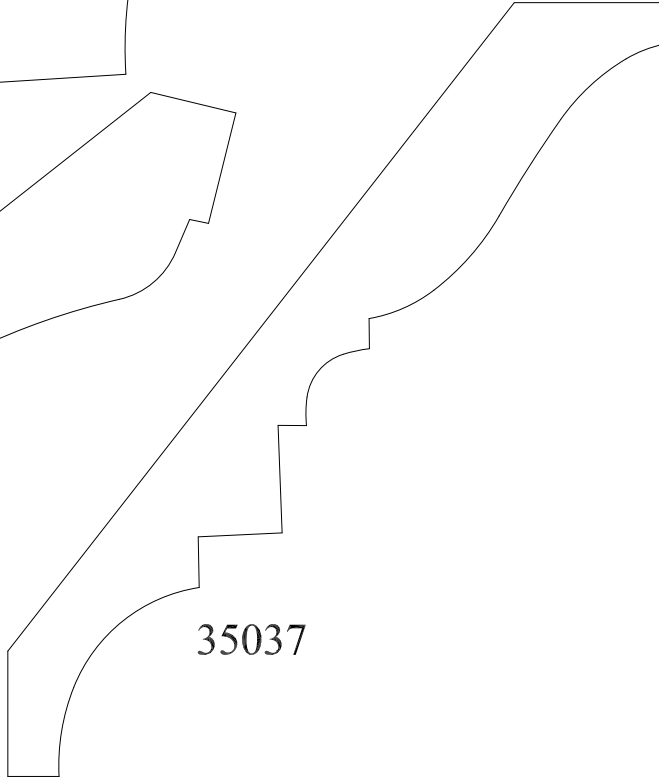

35037



35039

|  |   |
|--|---|
|  | 924 W. 1st. Avenue<br>Denver, CO 80223<br>303-534-8263<br>Phone |
|  | 303-534-8266 Fax  |

|  |
|--|
|  |
|--|

|              |          |
|--------------|----------|
| Approved by: | MM/DD/YY |
| Drawn:       |          |
| File name:   |          |

|           |             |
|-----------|-------------|
| Scale 1:1 | Sheet 3-5-8 |
|-----------|-------------|

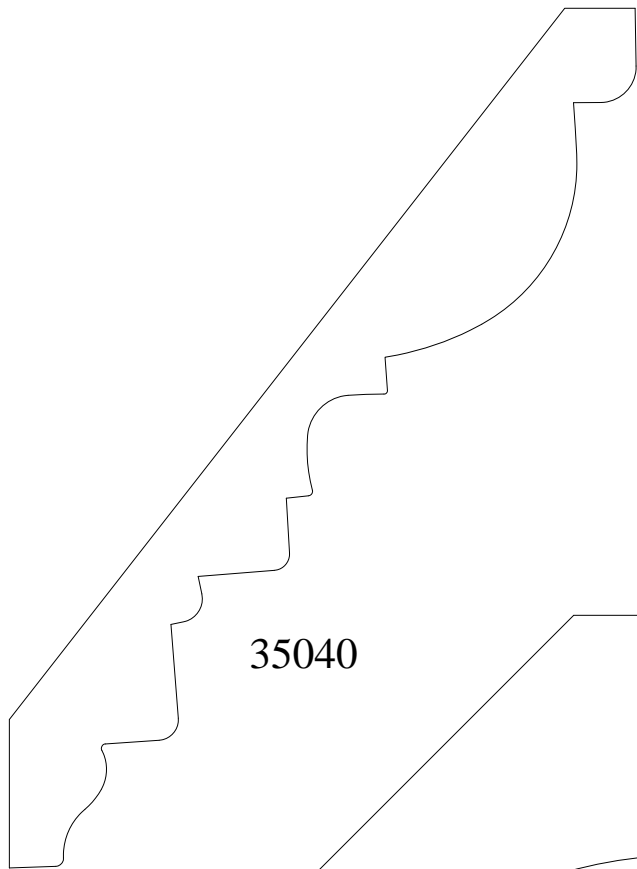

35040

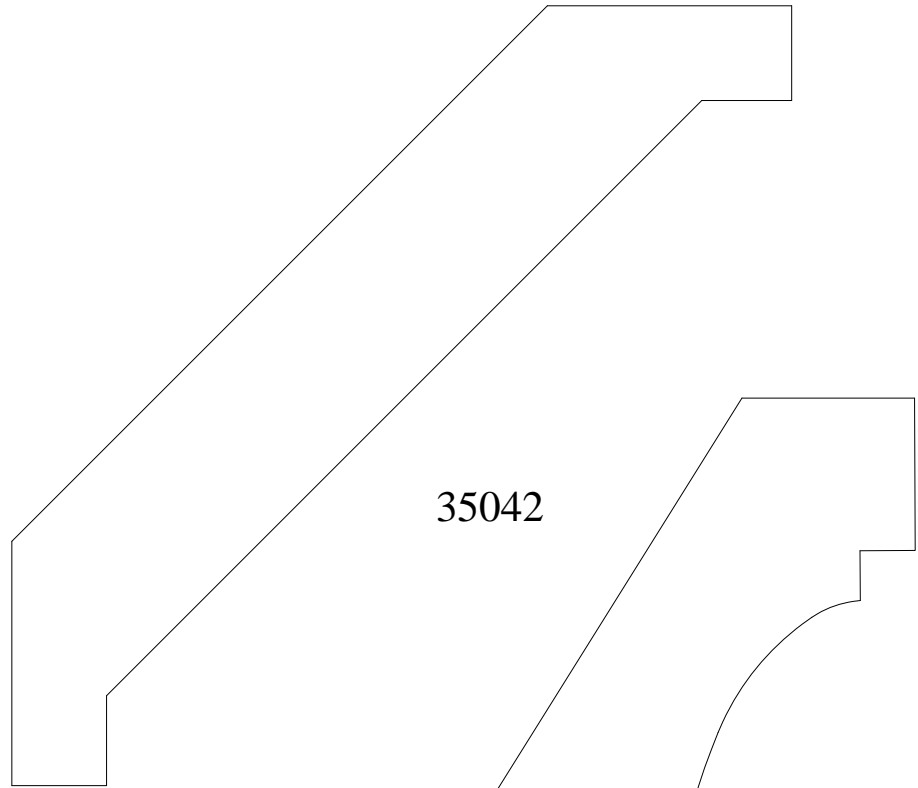

35042

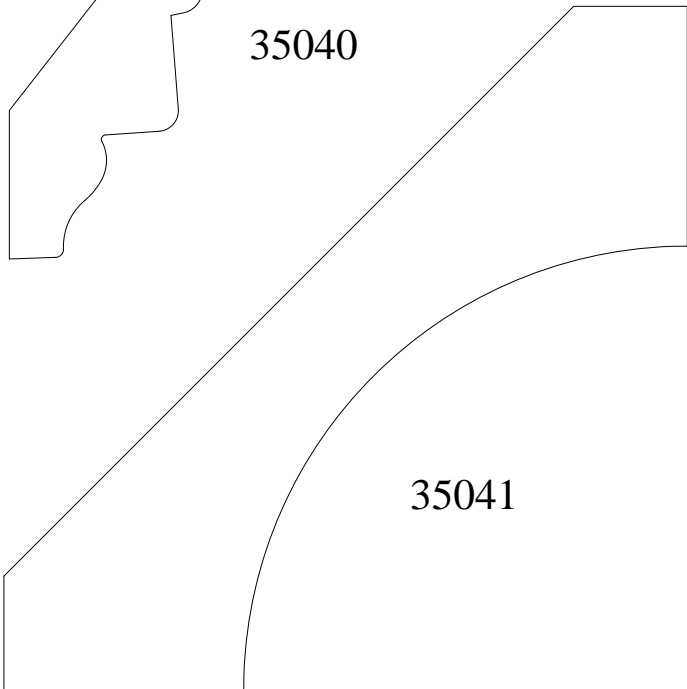

35041

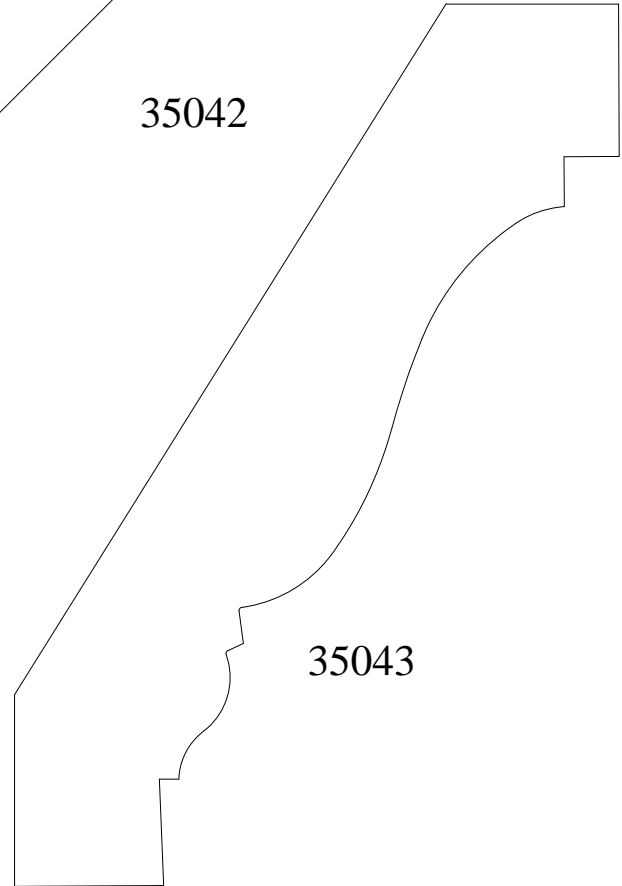

35043

|   |   |
|---|---|
| <p>EST. 1879</p> <p><b>S T A R K</b></p> <p>L U M B E R C O M P A N Y</p> <p>FINE WOOD MOULDING</p> | <p>924 W. 1st. Avenue<br/>         Denver, CO 80223<br/>         303-534-8263 Phone<br/>         303-534-8266 Fax</p> |
|---|---|

|              |          |             |
|--------------|----------|-------------|
| Approved by: | MM/DD/YY |             |
| Drawn:       |          |             |
| File name:   |          | Scale 1:1   |
|              |          | Sheet 3-5-9 |

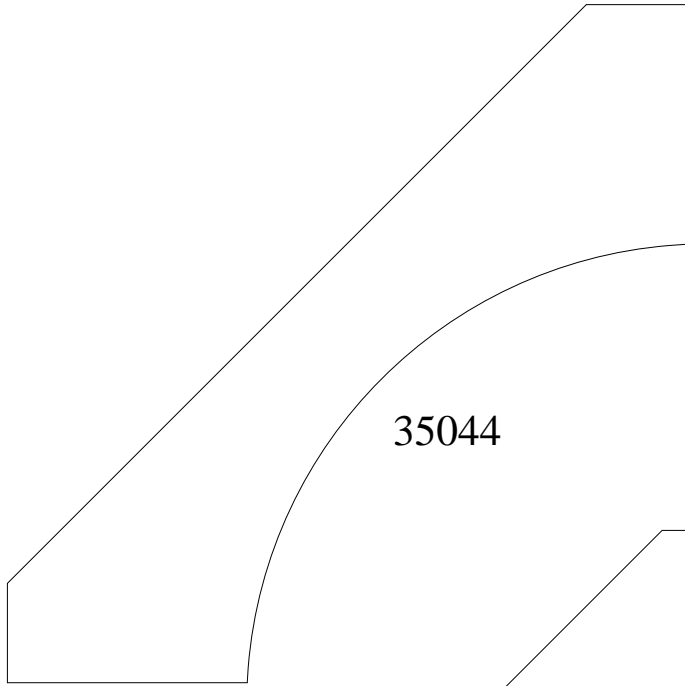

35044

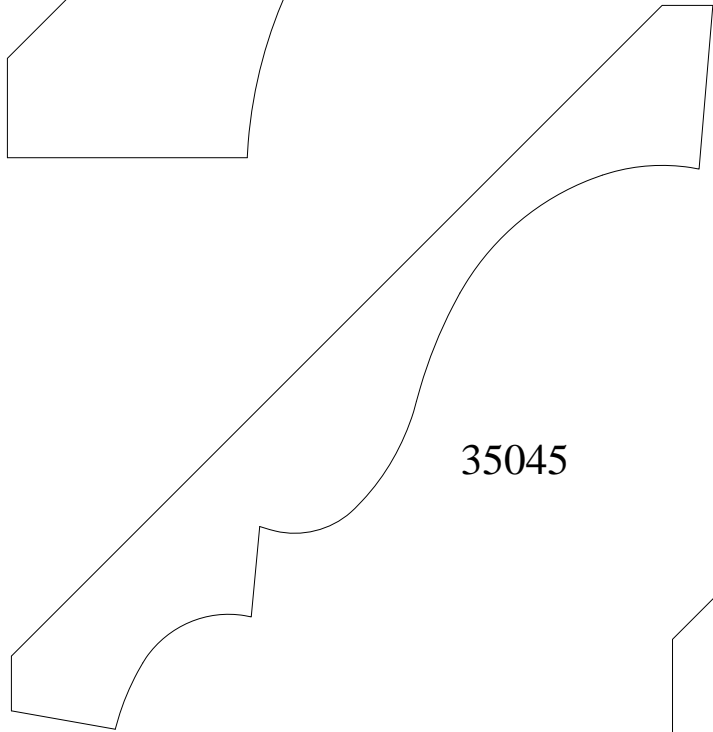

35045

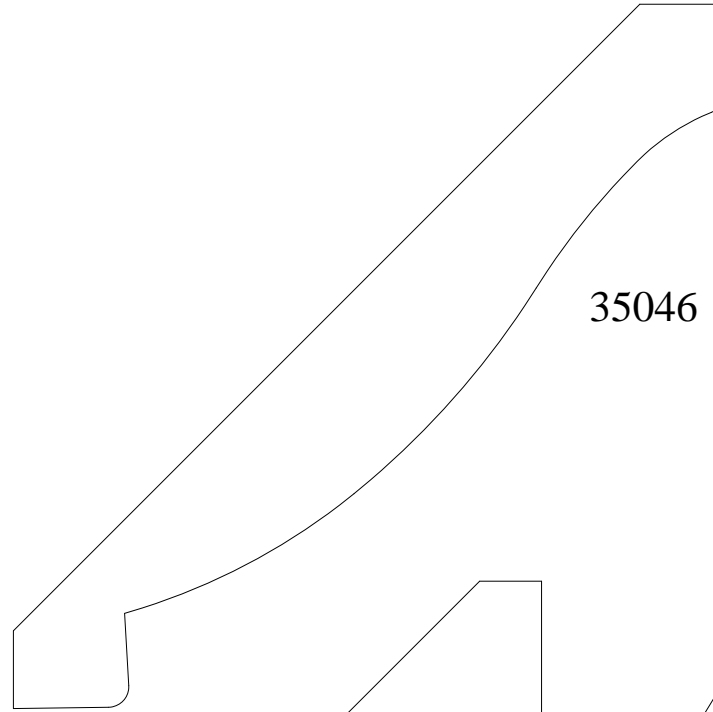

35046

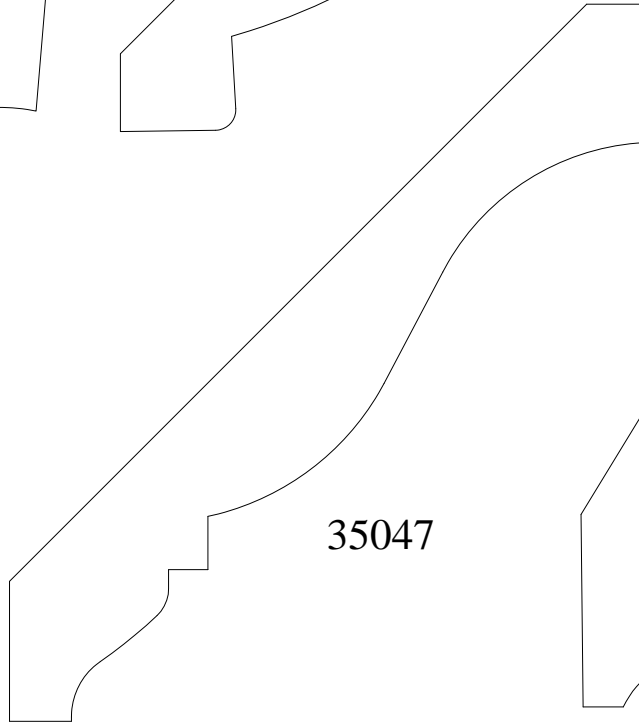

35047

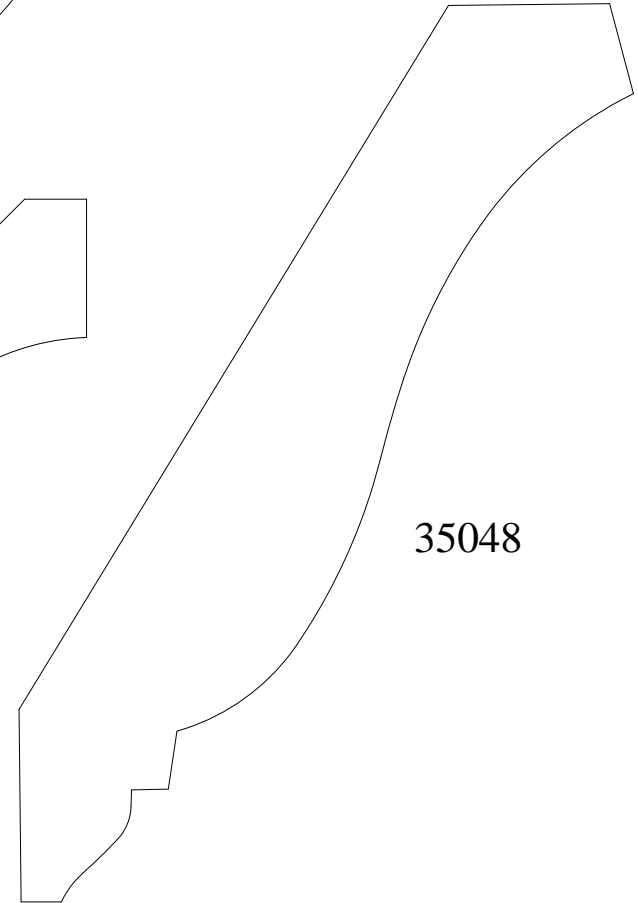

35048

EST. 1879

**S T A R K**

L U M B E R C O M P A N Y

FINE WOOD MOULDING

924 W. 1st. Avenue  
 Denver, CO 80223  
 303-534-8263 Phone  
 303-534-8266 Fax

|              |          |                        |
|--------------|----------|------------------------|
| Approved by: | MM/DD/YY |                        |
| Drawn:       |          |                        |
| File name:   |          | Scale 1:1 Sheet 3-5-10 |

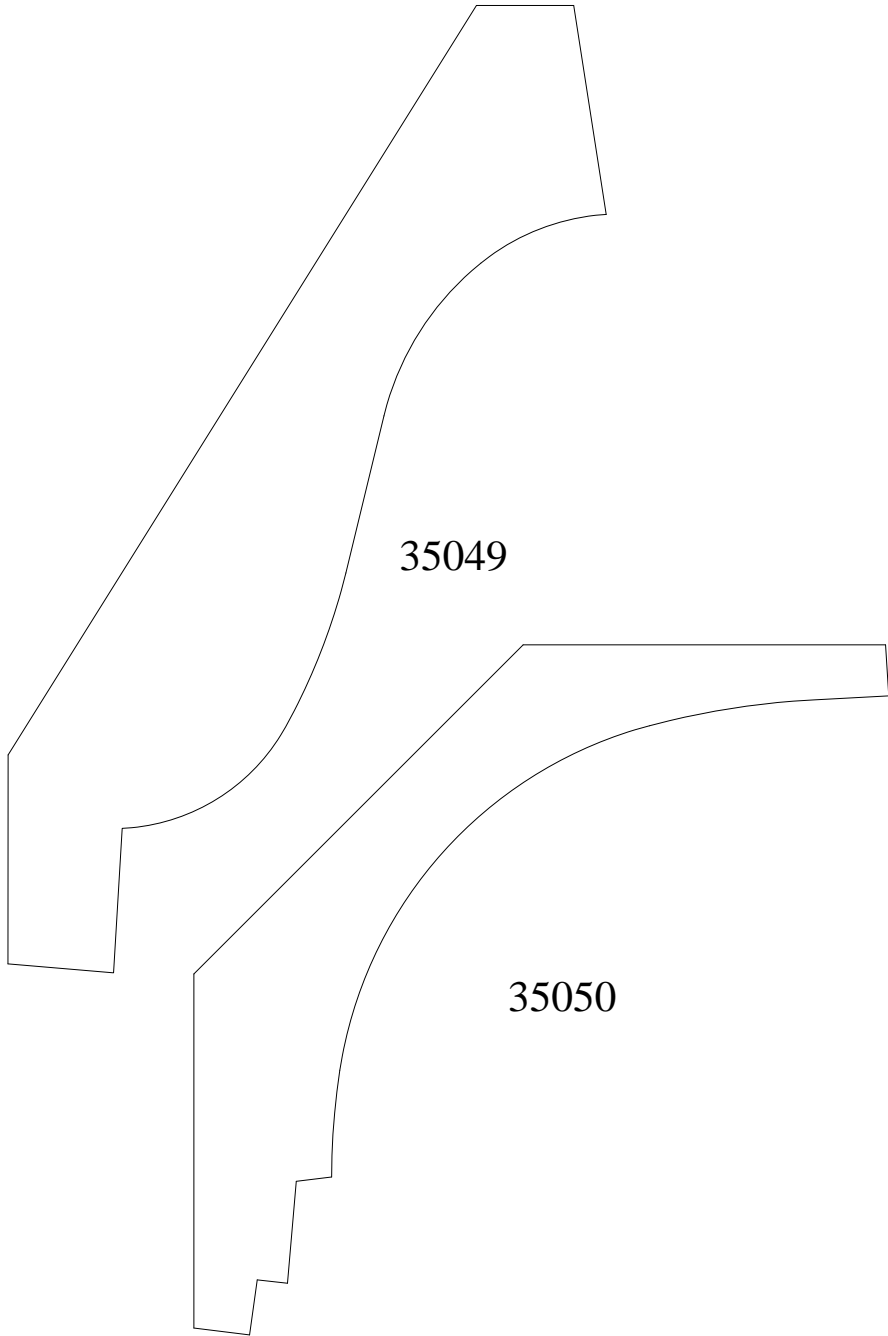

35049

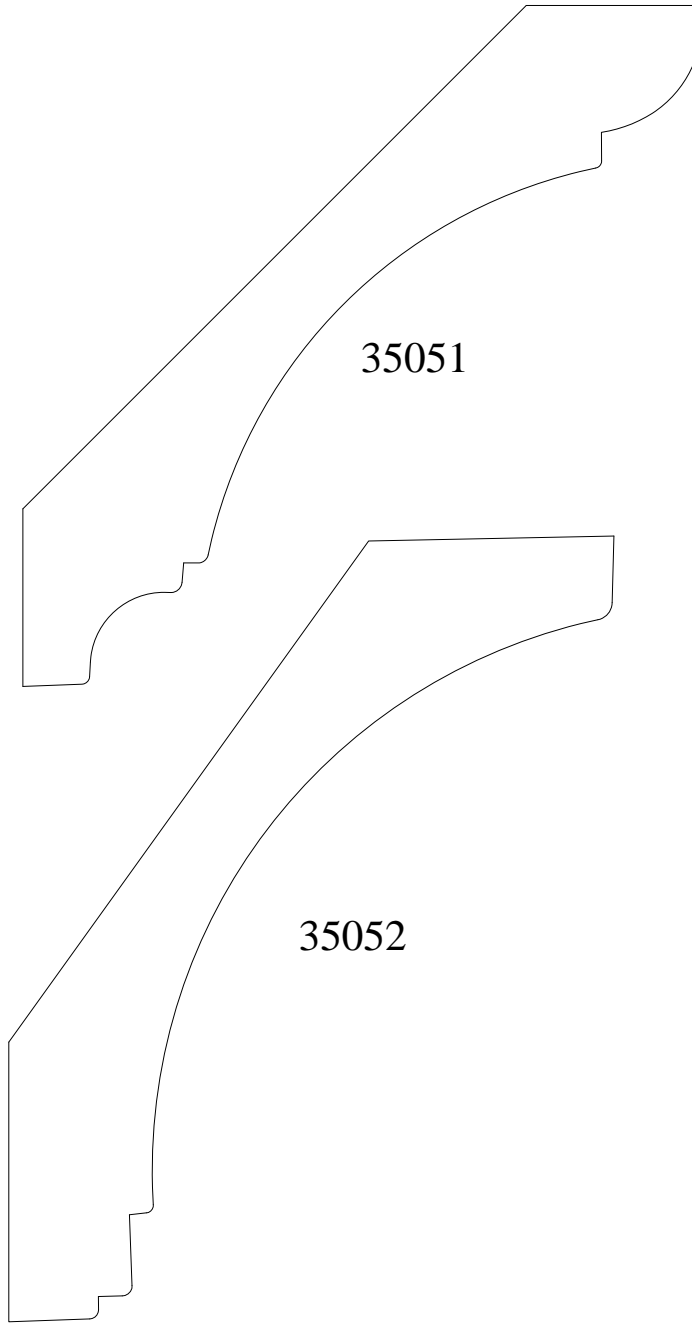

35051

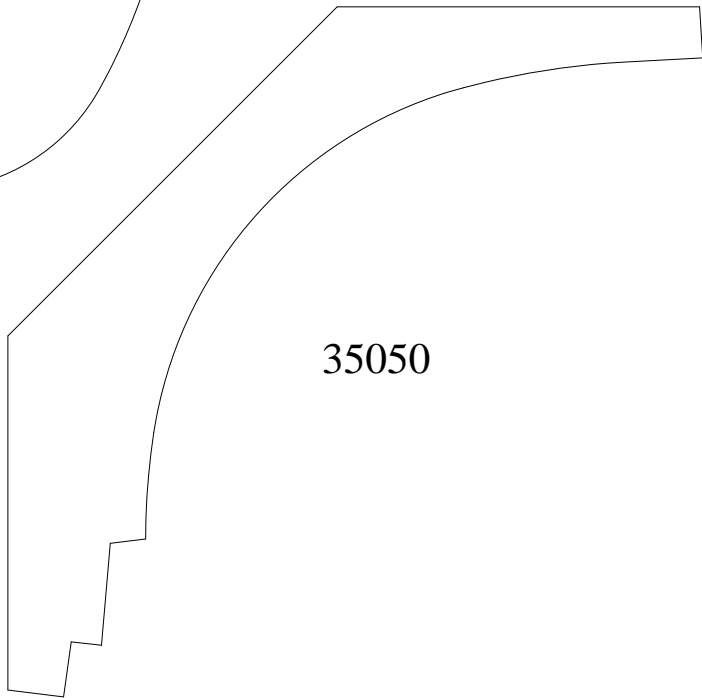

35050

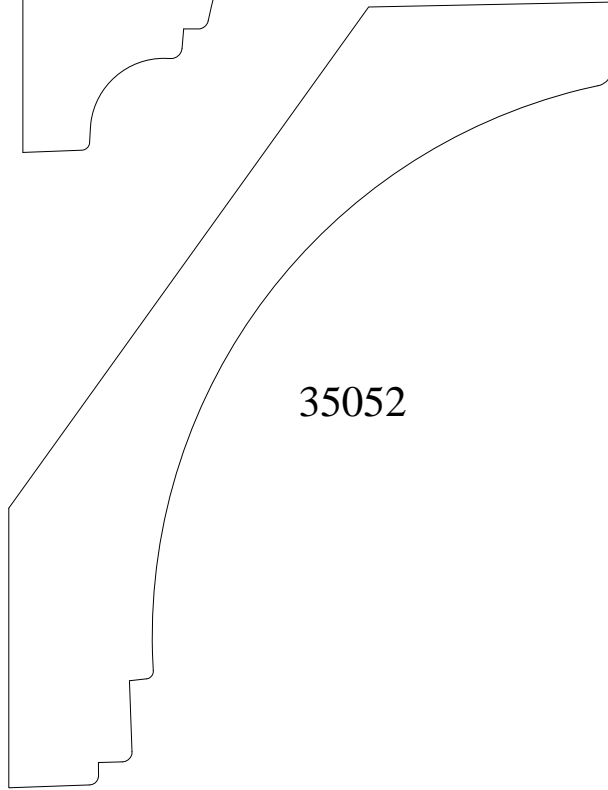

35052



924 W. 1st. Avenue  
Denver, CO 80223  
303-534-8263 Phone  
303-534-8266 Fax

|              |          |           |              |
|--------------|----------|-----------|--------------|
| Approved by: | MM/DD/YY |           |              |
| Drawn:       |          |           |              |
| File name:   |          | Scale 1:1 | Sheet 3-5-11 |

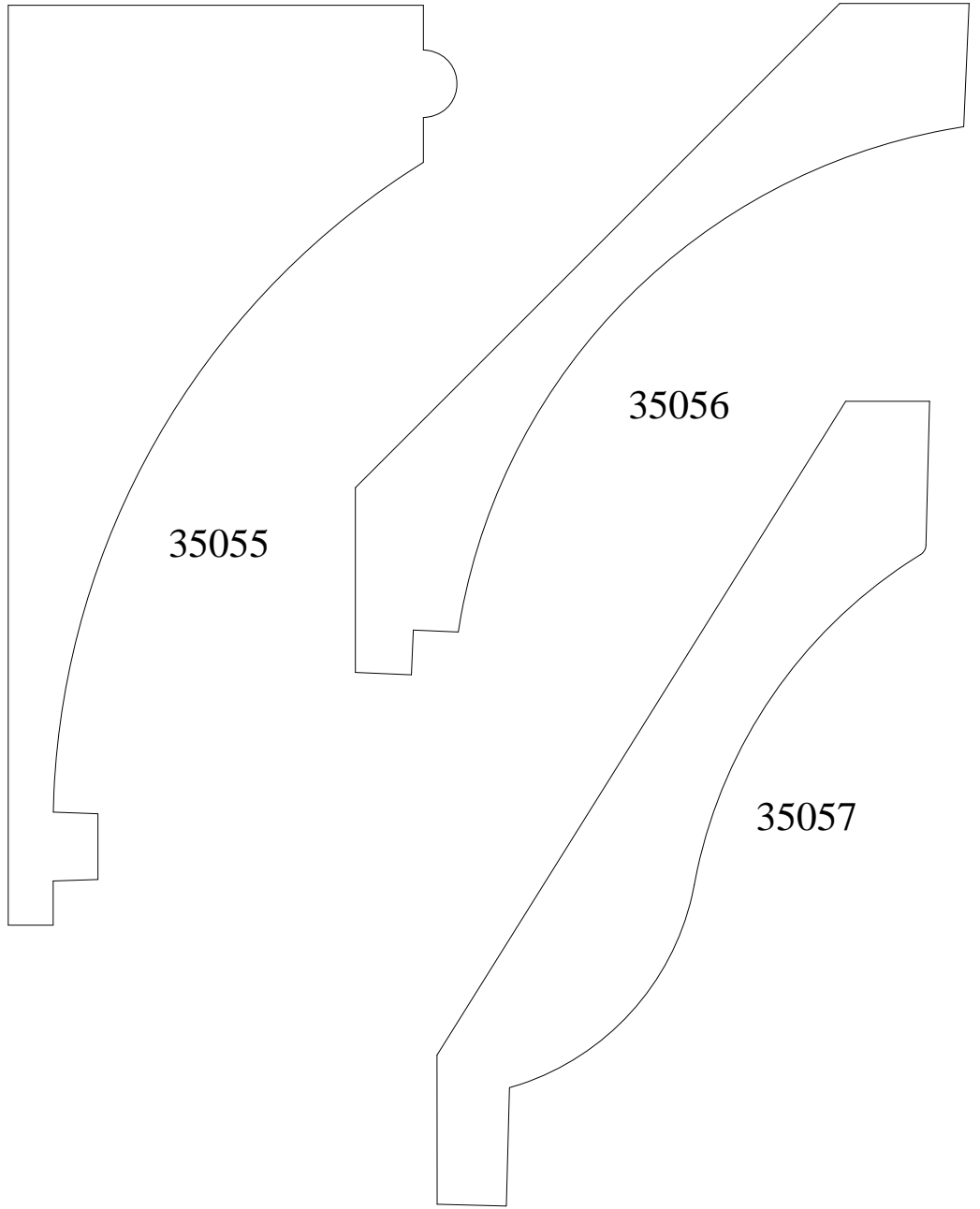
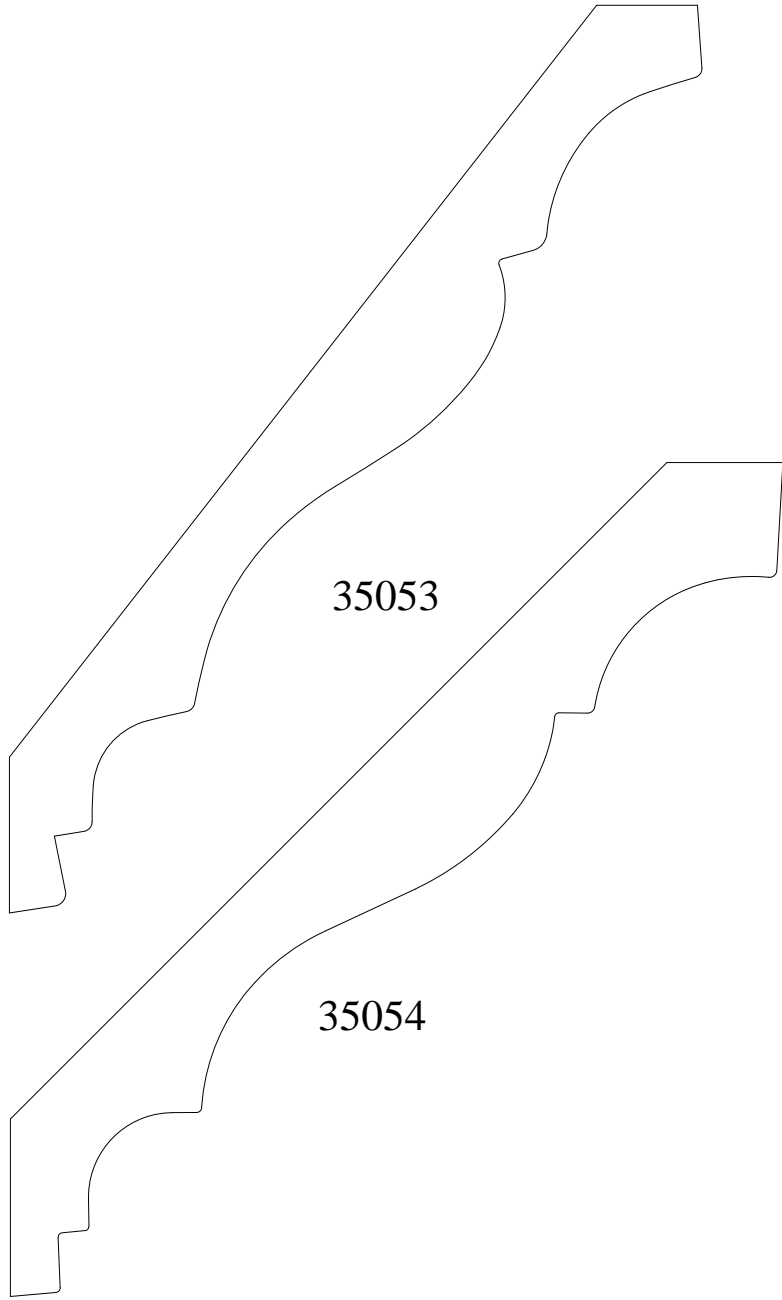

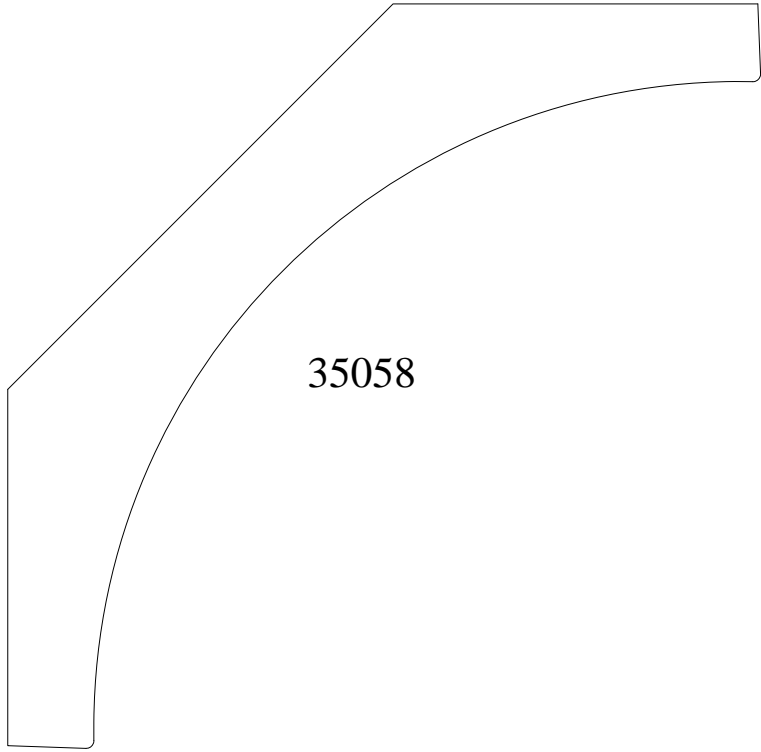

35058

|   |  |              |          |
|---|--|--------------|----------|
| <p>EST. 1879</p> <p><b>S T A R K</b></p> <p>L U M B E R C O M P A N Y</p> <p>FINE WOOD MOULDING</p> | <p>924 W. 1st. Avenue<br/>Denver, CO 80223<br/>303-534-8263 Phone<br/>303-534-8266 Fax</p> | Approved by: | MM/DD/YY |
|   |  | Drawn:       |          |
|   |  | File name:   |          |

|              |          |
|--------------|----------|
| Approved by: | MM/DD/YY |
| Drawn:       |          |
| File name:   |          |



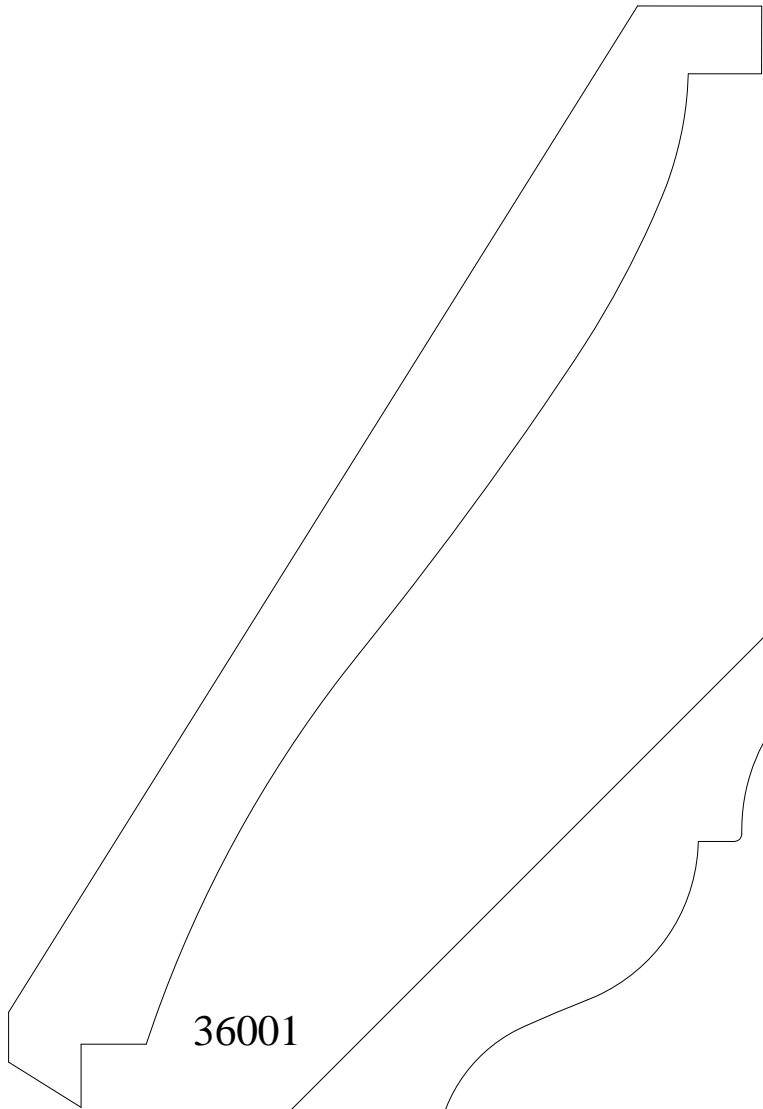

36001

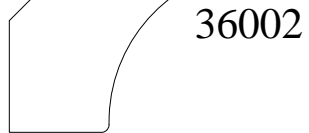

36002

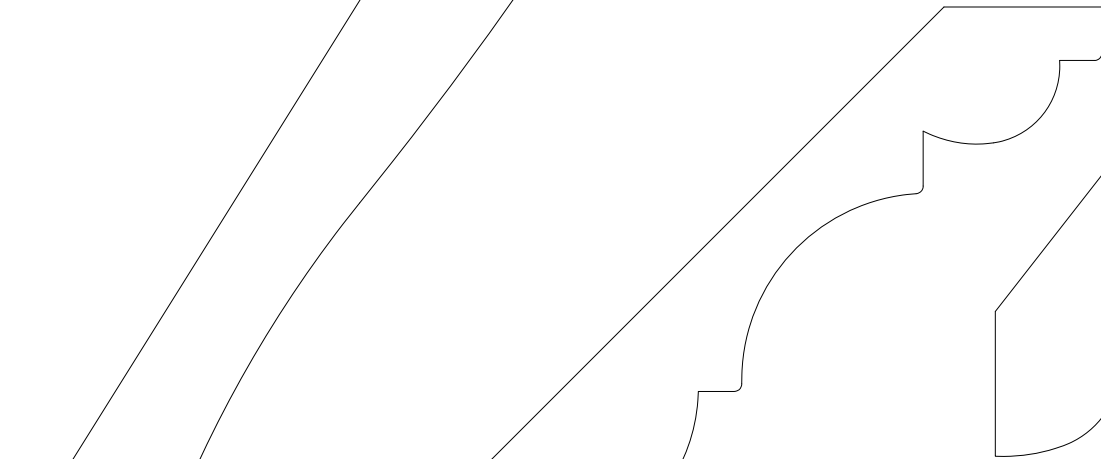

36003



36004

EST. 1879

**S T A R K**

L U M B E R C O M P A N Y

FINE WOOD MOULDING

924 W. 1st. Avenue  
 Denver, CO 80223  
 303-534-8263 Phone  
 303-534-8266 Fax

|              |          |             |
|--------------|----------|-------------|
| Approved by: | MM/DD/YY |             |
| Drawn:       |          |             |
| File name:   |          | Scale 1:1   |
|              |          | Sheet 3-6-1 |

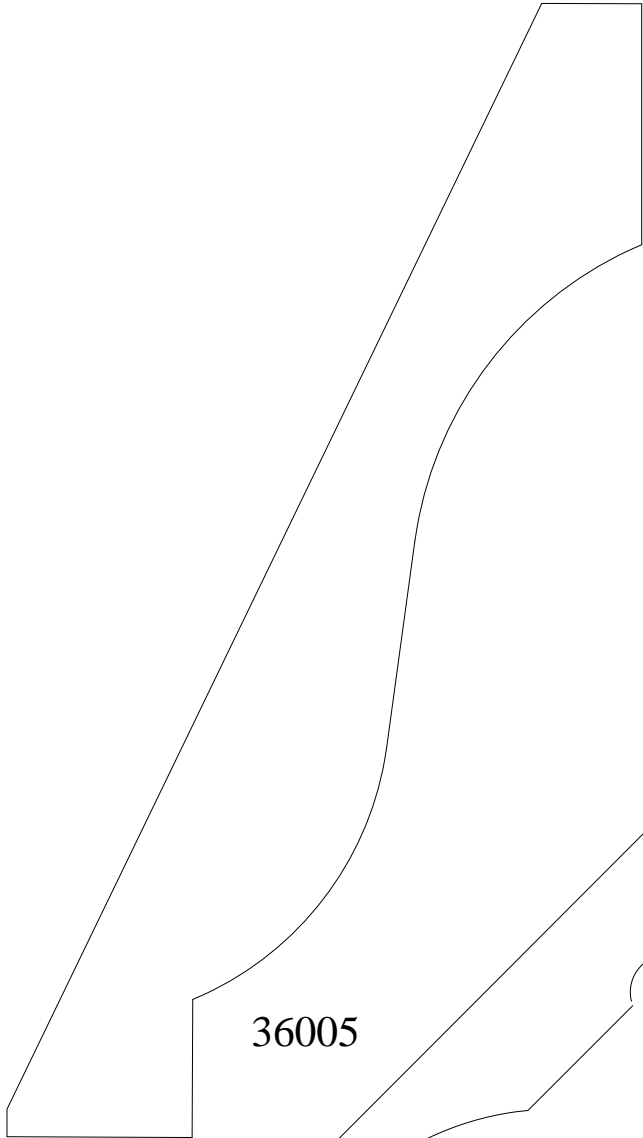

36005

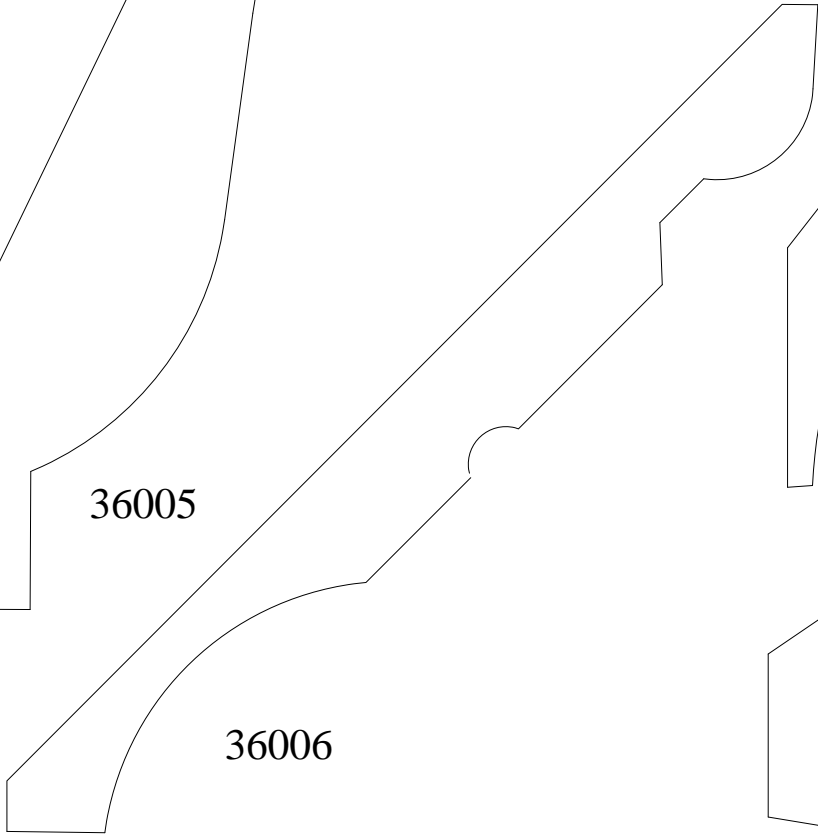

36006

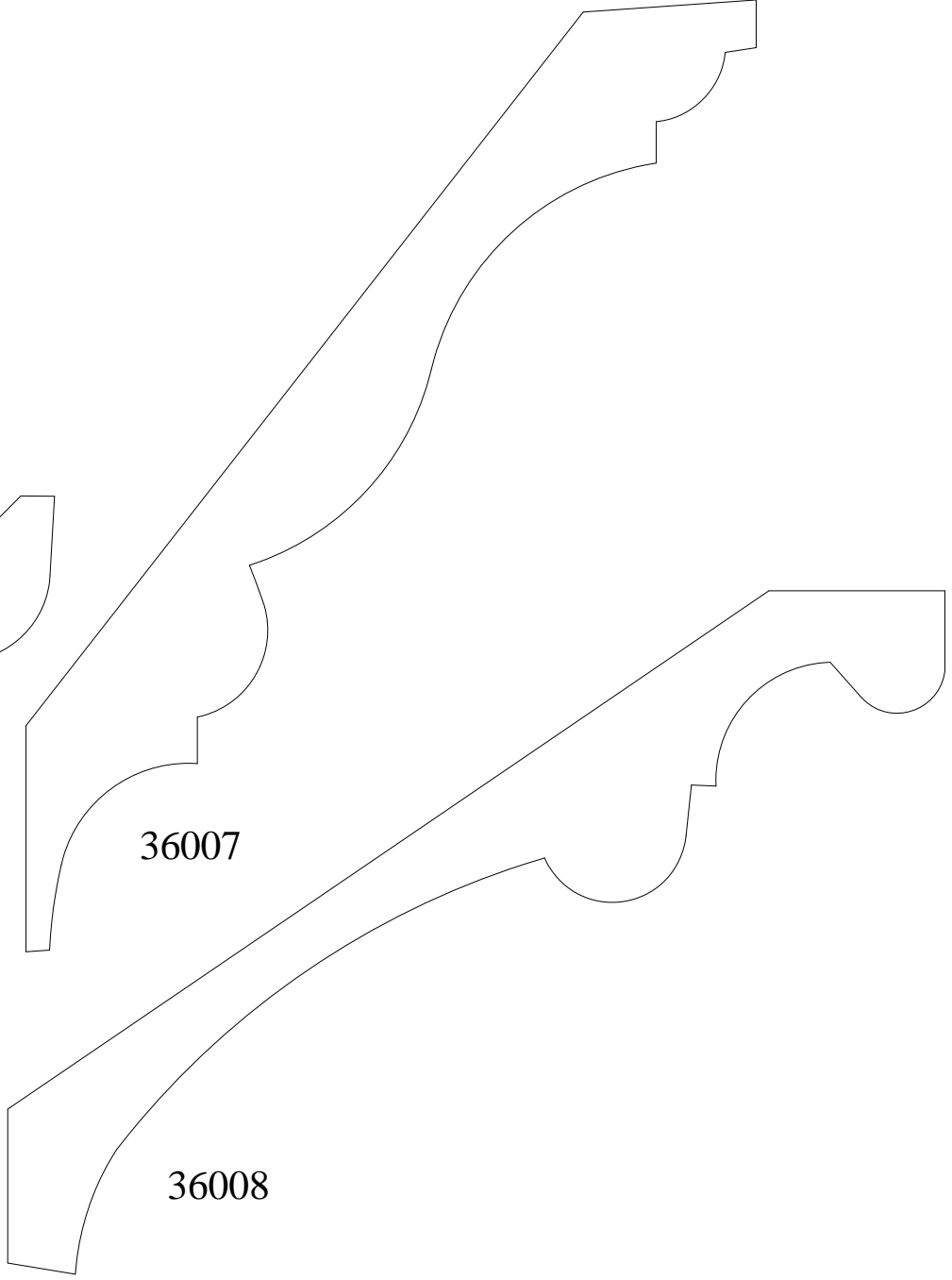

36007

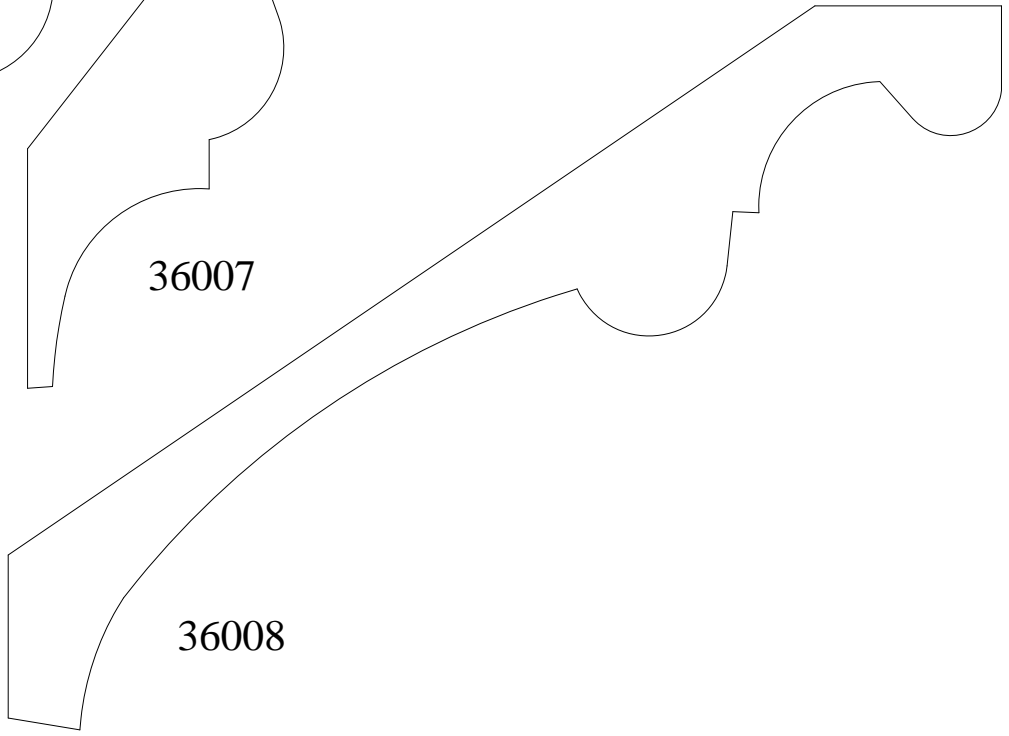

36008

EST. 1879

**S T A R K**

L U M B E R C O M P A N Y

FINE WOOD MOULDING

924 W. 1st. Avenue  
 Denver, CO 80223  
 303-534-8263 Phone  
 303-534-8266 Fax

|              |          |             |
|--------------|----------|-------------|
| Approved by: | MM/DD/YY |             |
| Drawn:       |          |             |
| File name:   |          | Scale 1:1   |
|              |          | Sheet 3-6-2 |

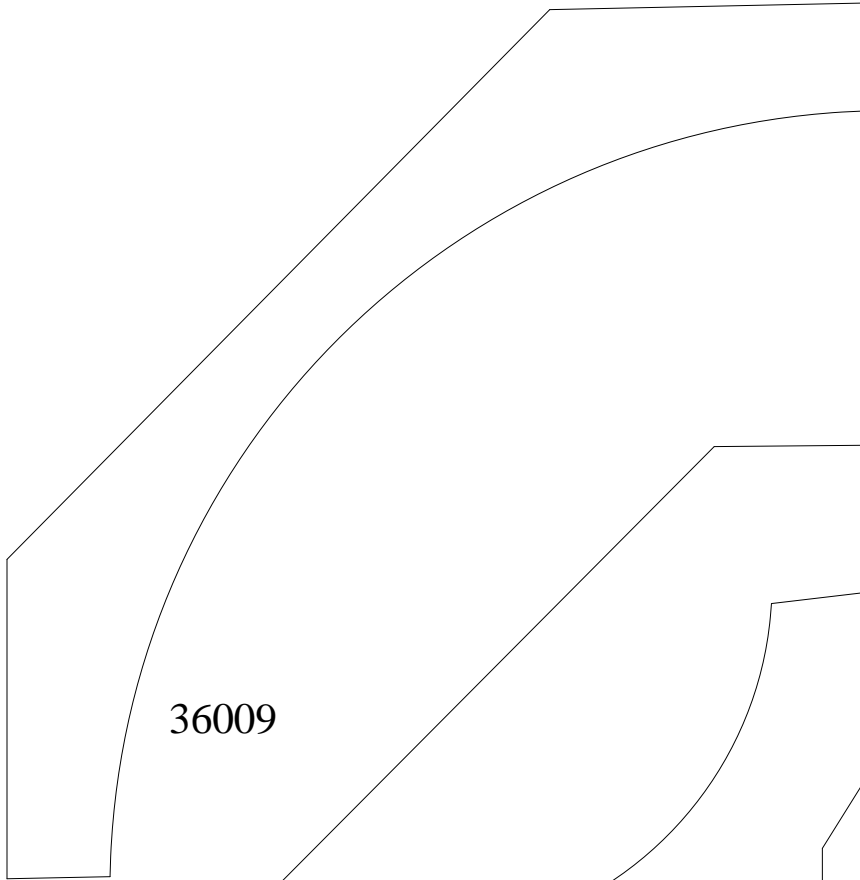

36009



36010

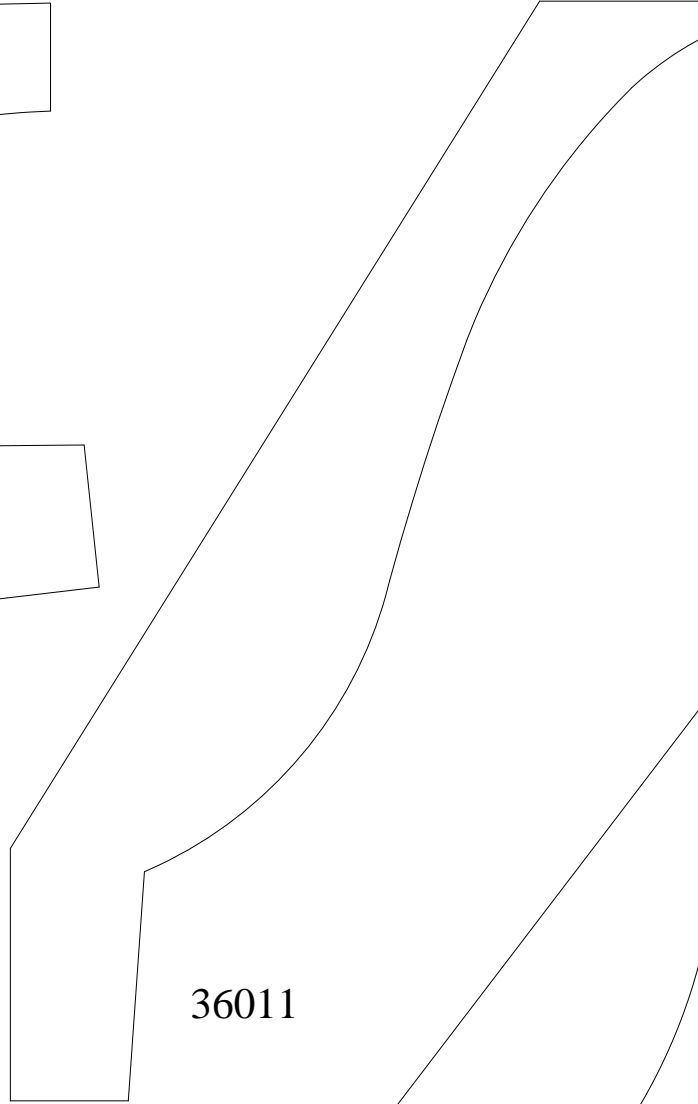

36011



36012

EST. 1879

**S T A R K**

L U M B E R C O M P A N Y

FINE WOOD MOULDING

924 W. 1st. Avenue  
 Denver, CO 80223  
 303-534-8263 Phone  
 303-534-8266 Fax

|              |          |
|--------------|----------|
| Approved by: | MM/DD/YY |
| Drawn:       |          |
| File name:   |          |

|           |             |
|-----------|-------------|
| Scale 1:1 | Sheet 3-6-3 |
|-----------|-------------|

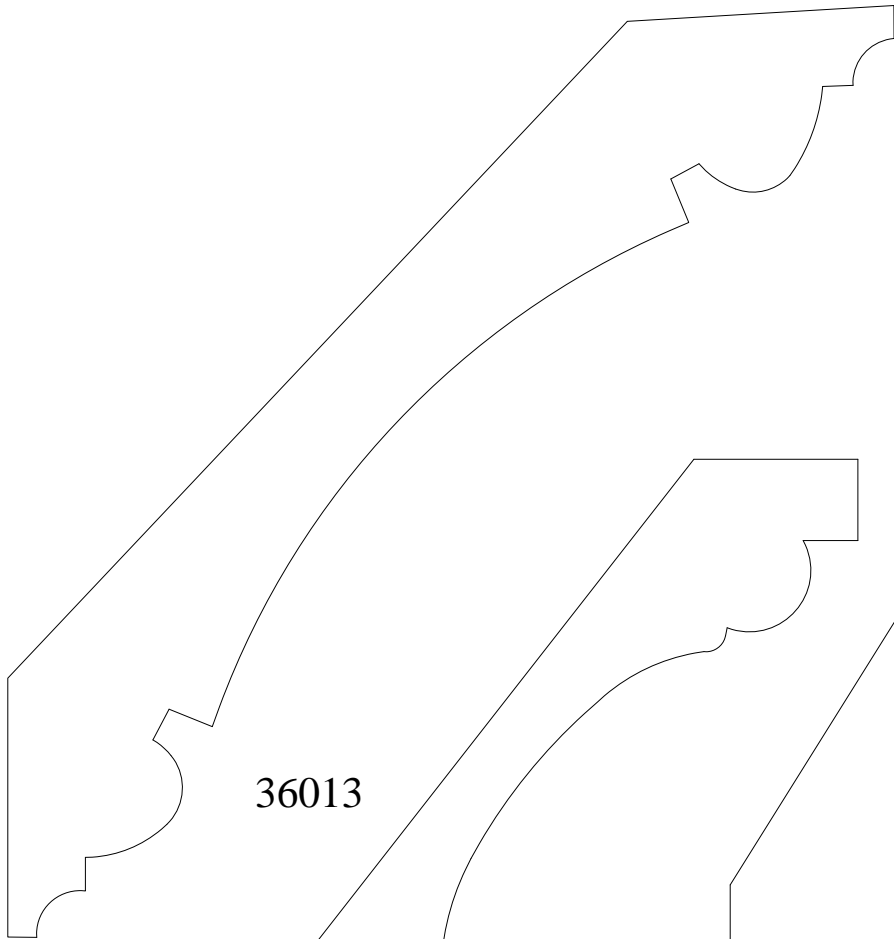

36013

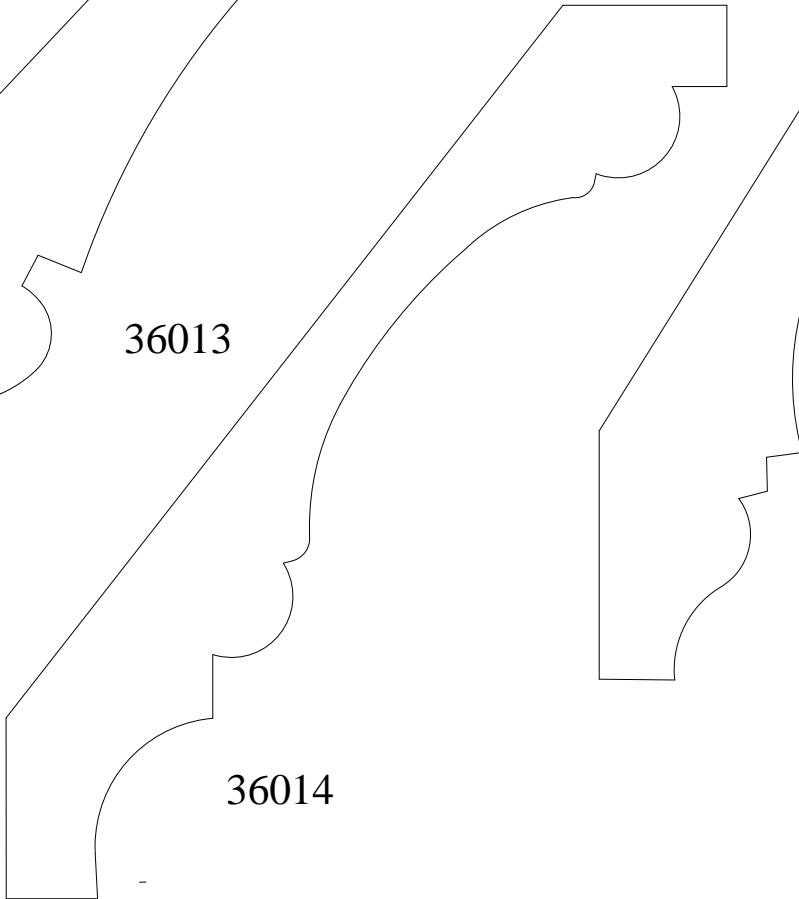

36014

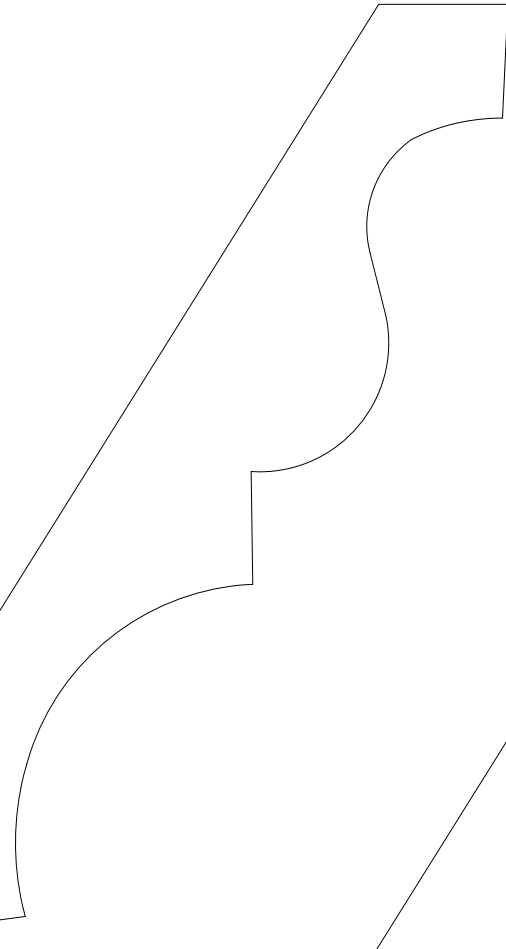

36015



36016

EST. 1879

**S T A R K**

L U M B E R C O M P A N Y

FINE WOOD MOULDING

924 W. 1st. Avenue  
 Denver, CO 80223  
 303-534-8263 Phone  
 303-534-8266 Fax

|              |          |             |
|--------------|----------|-------------|
| Approved by: | MM/DD/YY |             |
| Drawn:       |          |             |
| File name:   |          | Scale 1:1   |
|              |          | Sheet 3-6-4 |

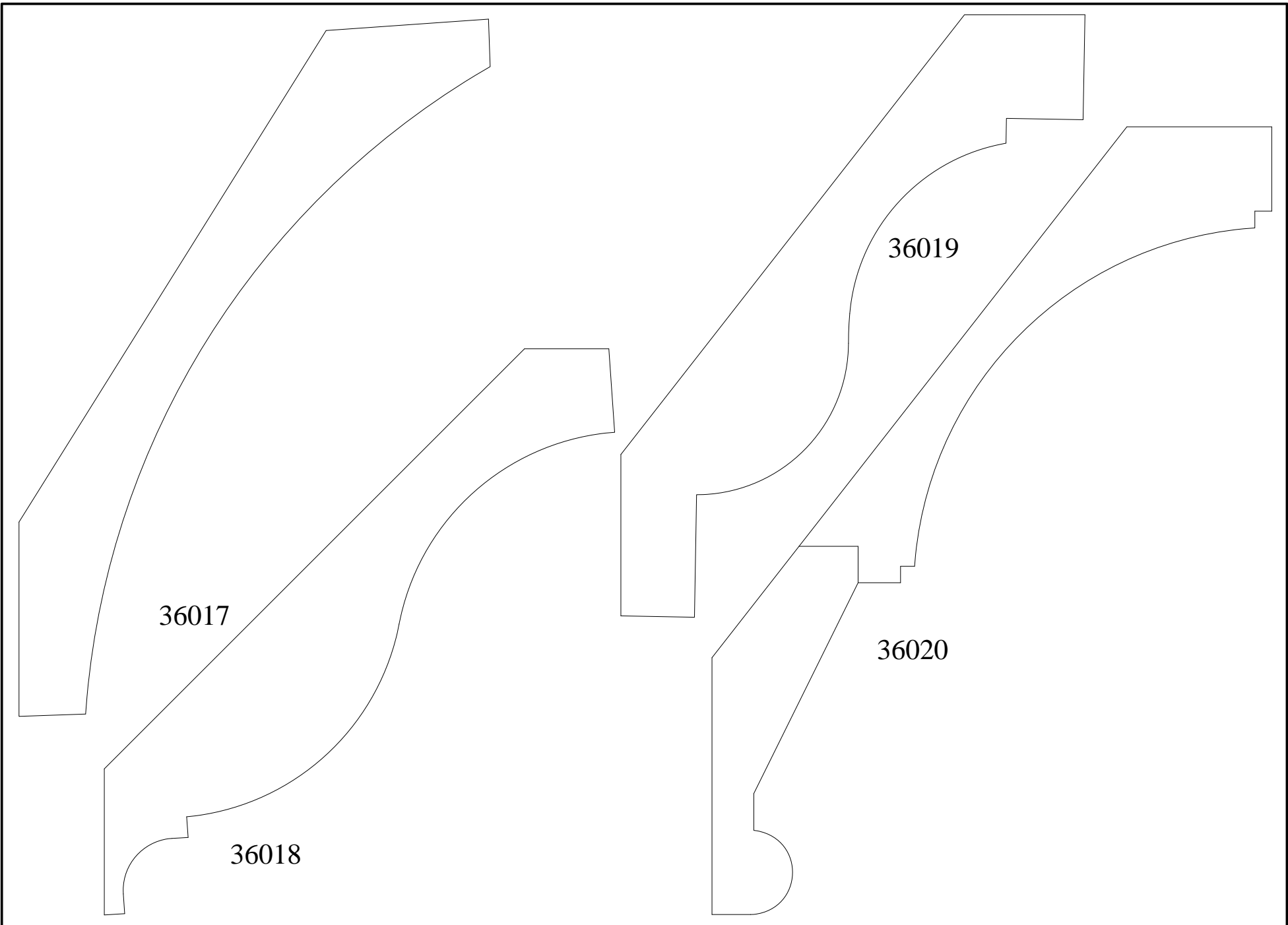

36017

36018

36019

36020

|  |  |
|--|--|
| <small>EST. 1879</small><br><b>S T A R K</b><br>L U M B E R C O M P A N Y<br><small>FINE WOOD MOULDING</small> | 924 W. 1st. Avenue<br>Denver, CO 80223<br>303-534-8263 Phone<br>303-534-8266 Fax |
|--|--|

|              |          |             |
|--------------|----------|-------------|
| Approved by: | MM/DD/YY |             |
| Drawn:       |          |             |
| File name:   |          | Scale 1:1   |
|              |          | Sheet 3-6-5 |

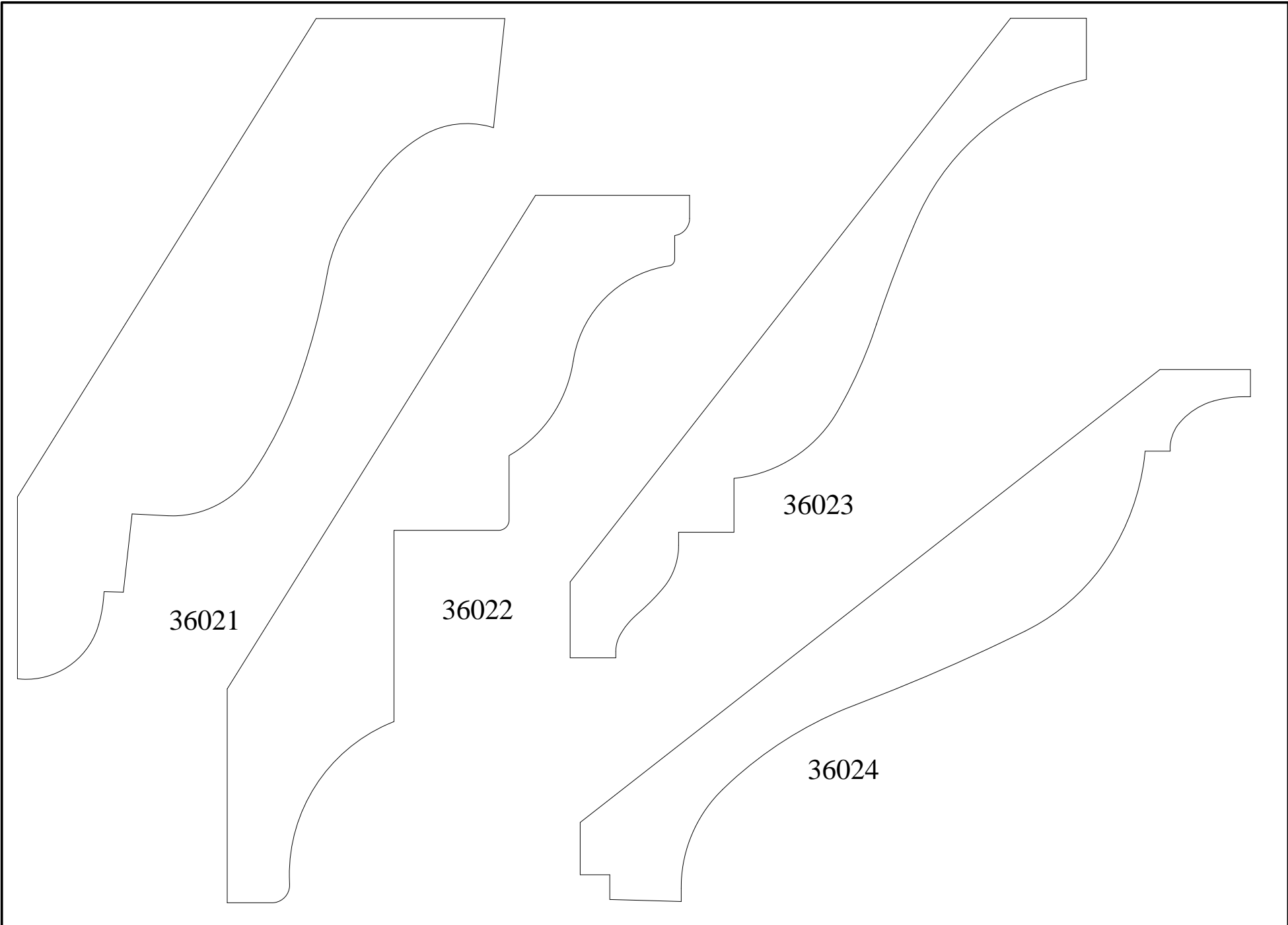

36021

36022

36023

36024

|   |   |
|---|---|
| <p>EST. 1879</p> <p><b>S T A R K</b></p> <p>L U M B E R C O M P A N Y</p> <p>FINE WOOD MOULDING</p> | <p>924 W. 1st. Avenue<br/>         Denver, CO 80223<br/>         303-534-8263 Phone<br/>         303-534-8266 Fax</p> |
|---|---|

|  |
|--|
|  |
|--|

|              |          |
|--------------|----------|
| Approved by: | MM/DD/YY |
| Drawn:       |          |
| File name:   |          |

|           |             |
|-----------|-------------|
|           |             |
| Scale 1:1 | Sheet 3-6-6 |



36025

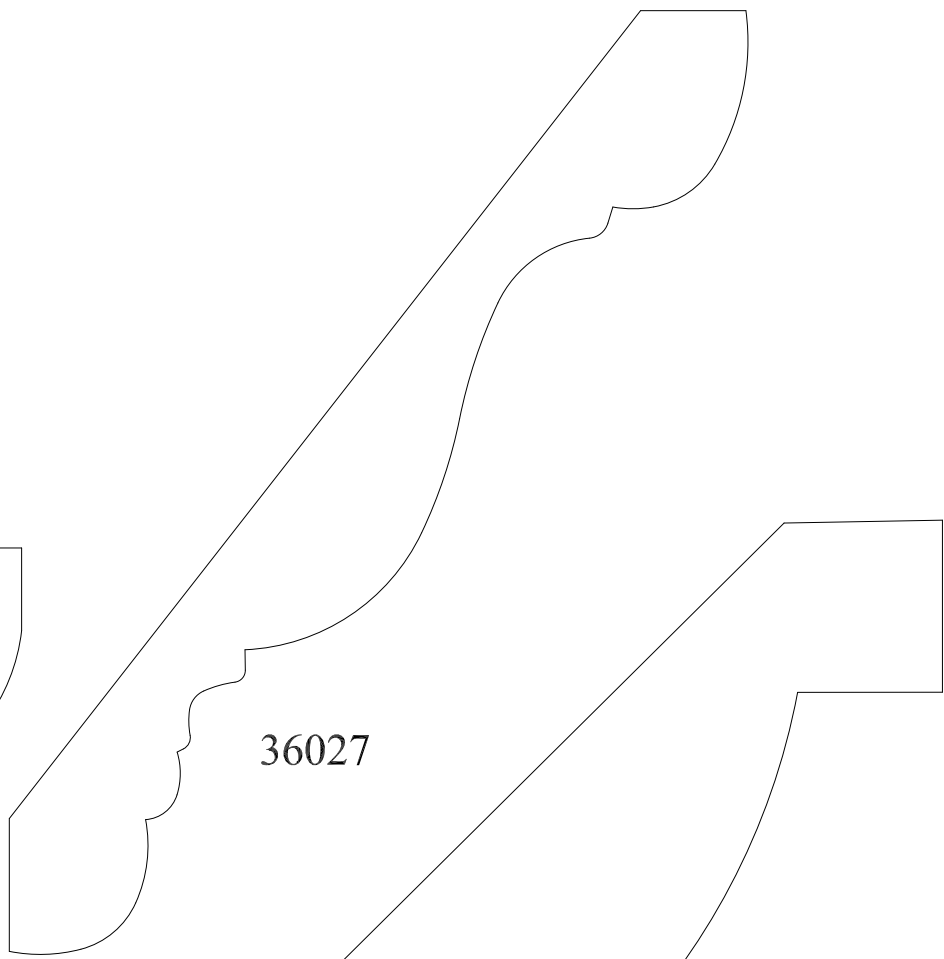

36027

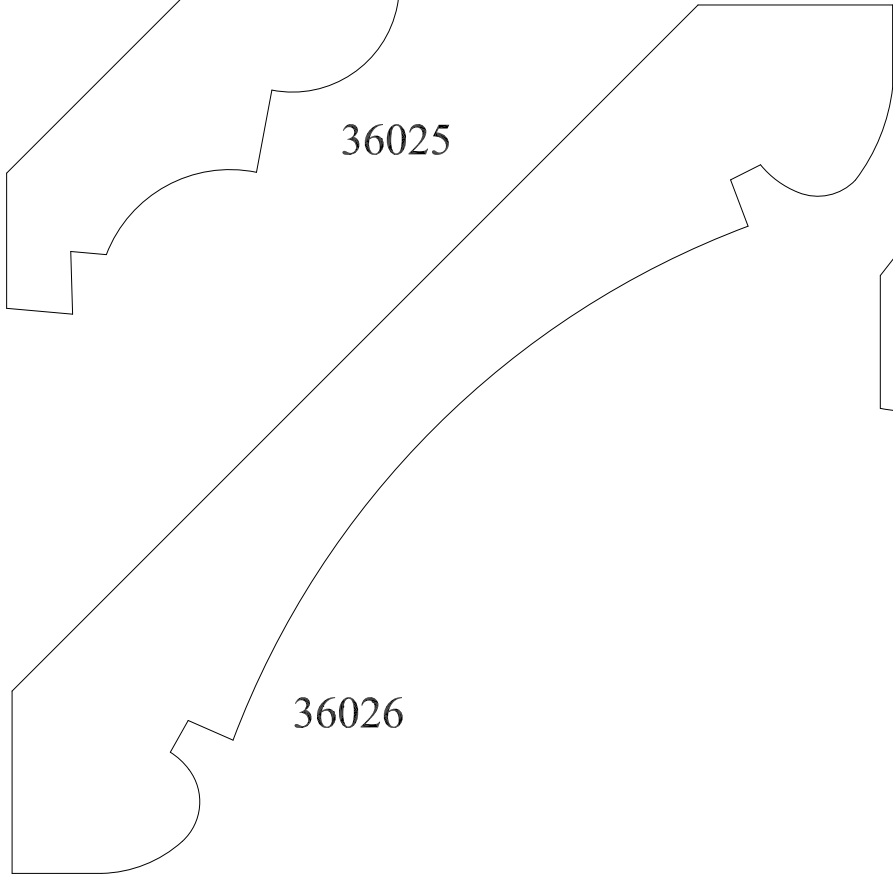

36026



36028

EST. 1879

**S T A R K**

L U M B E R C O M P A N Y

FINE WOOD MOULDING

924 W. 1st. Avenue  
Denver, CO 80223  
303-534-8263  
Phone  
303-534-8266 Fax

|  |
|--|
|  |
|  |
|  |

|              |          |
|--------------|----------|
| Approved by: | MM/DD/YY |
| Drawn:       |          |
| File name:   |          |

|           |             |
|-----------|-------------|
| Scale 1:1 | Sheet 3-6-7 |
|-----------|-------------|

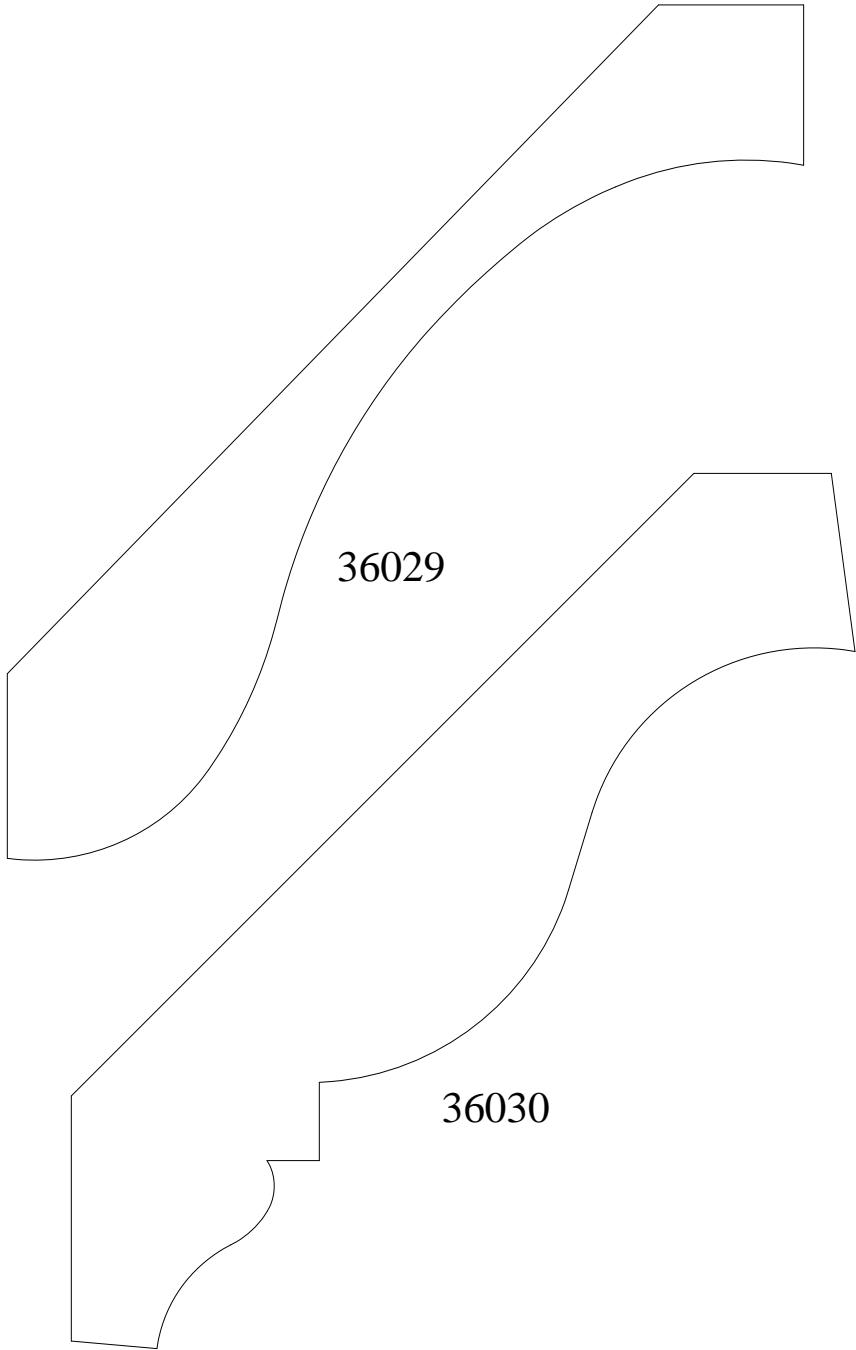

36029

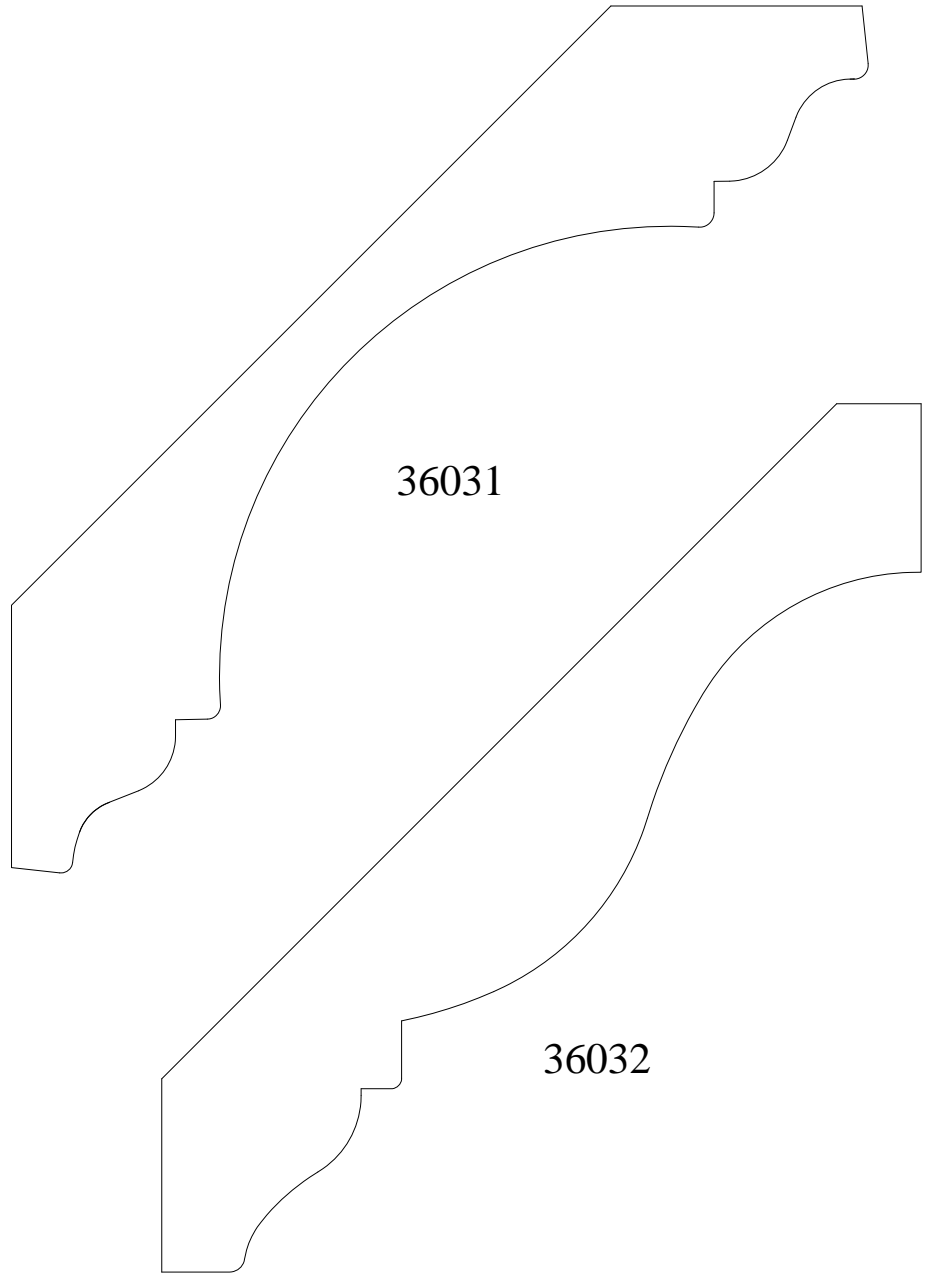

36031



36030



36032

EST. 1879  
**S T A R K**  
L U M B E R C O M P A N Y  
FINE WOOD MOULDING

924 W. 1st. Avenue  
Denver, CO 80223  
303-534-8263 Phone  
303-534-8266 Fax

|              |          |                       |
|--------------|----------|-----------------------|
| Approved by: | MM/DD/YY |                       |
| Drawn:       |          |                       |
| File name:   |          | Scale 1:1 Sheet 3-6-8 |



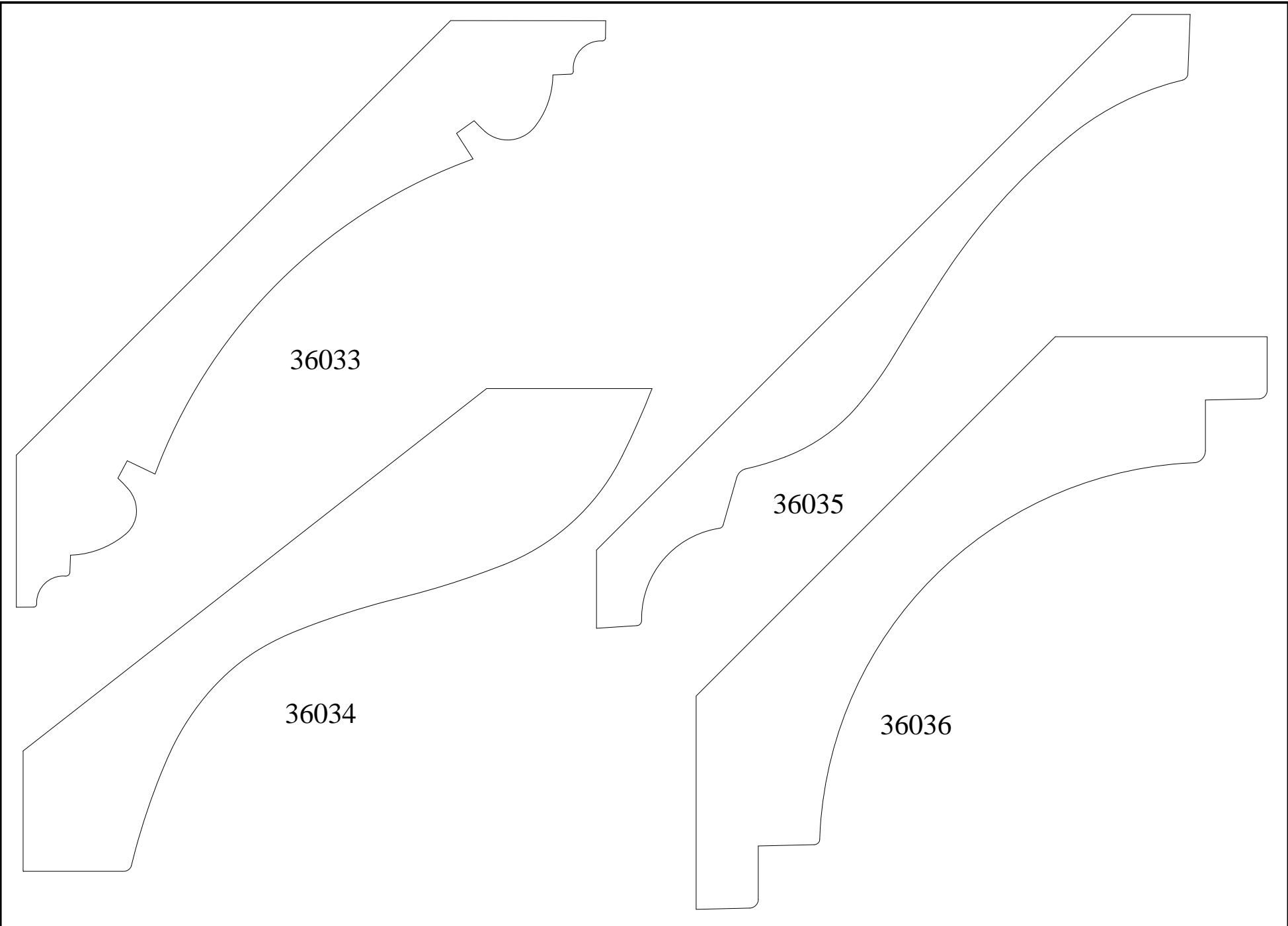

|   |  |
|---|--|
| <p>EST. 1879</p> <p><b>S T A R K</b></p> <p>L U M B E R C O M P A N Y</p> <p>FINE WOOD MOULDING</p> | <p>924 W. 1st. Avenue<br/>Denver, CO 80223<br/>303-534-8263 Phone<br/>303-534-8266 Fax</p> |
|   |  |

|  |
|--|
|  |
|--|

|              |          |
|--------------|----------|
| Approved by: | MM/DD/YY |
| Drawn:       |          |
| File name:   |          |

|           |             |
|-----------|-------------|
| Scale 1:1 | Sheet 3-6-9 |
|-----------|-------------|



36037

36038

36039

EST. 1879  
**S T A R K**  
L U M B E R C O M P A N Y  
FINE WOOD MOULDING

924 W. 1st. Avenue  
Denver, CO 80223  
303-534-8263 Phone  
303-534-8266 Fax

|              |          |           |              |
|--------------|----------|-----------|--------------|
| Approved by: | MM/DD/YY |           |              |
| Drawn:       |          |           |              |
| File name:   |          | Scale 1:1 | Sheet 3-6-10 |

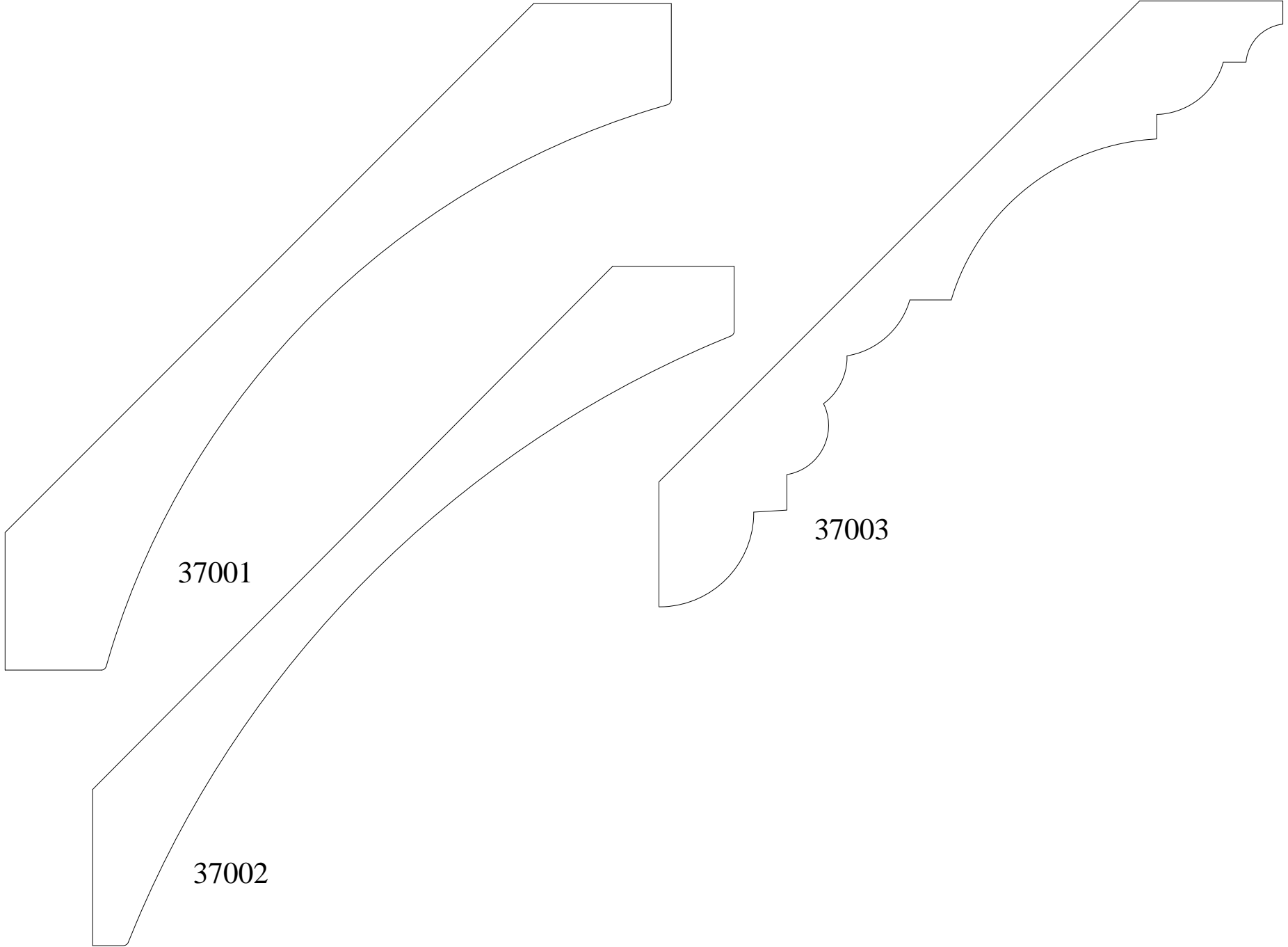

37001

37002

37003

EST. 1879  
**S T A R K**  
L U M B E R C O M P A N Y  
FINE WOOD MOULDING

924 W. 1st. Avenue  
Denver, CO 80223  
303-534-8263 Phone  
303-534-8266 Fax

|              |          |             |
|--------------|----------|-------------|
| Approved by: | MM/DD/YY |             |
| Drawn:       |          |             |
| File name:   |          | Scale 1:1   |
|              |          | Sheet 3-7-1 |

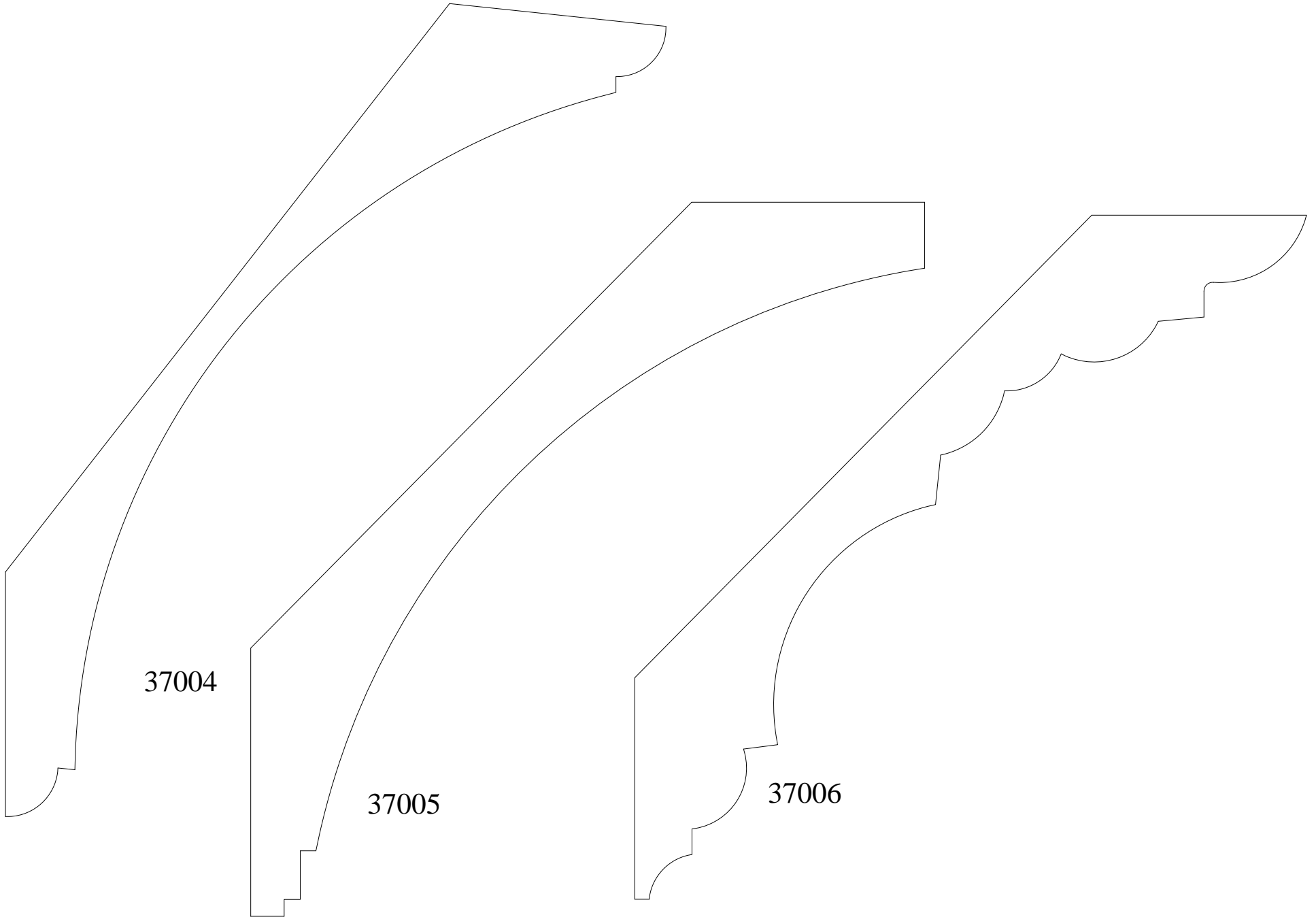

37004

37005

37006

EST. 1879

**S T A R K**

L U M B E R C O M P A N Y

FINE WOOD MOULDING

924 W. 1st. Avenue  
 Denver, CO 80223  
 303-534-8263 Phone  
 303-534-8266 Fax

|              |          |             |
|--------------|----------|-------------|
| Approved by: | MM/DD/YY |             |
| Drawn:       |          |             |
| File name:   |          | Scale 1:1   |
|              |          | Sheet 3-7-2 |

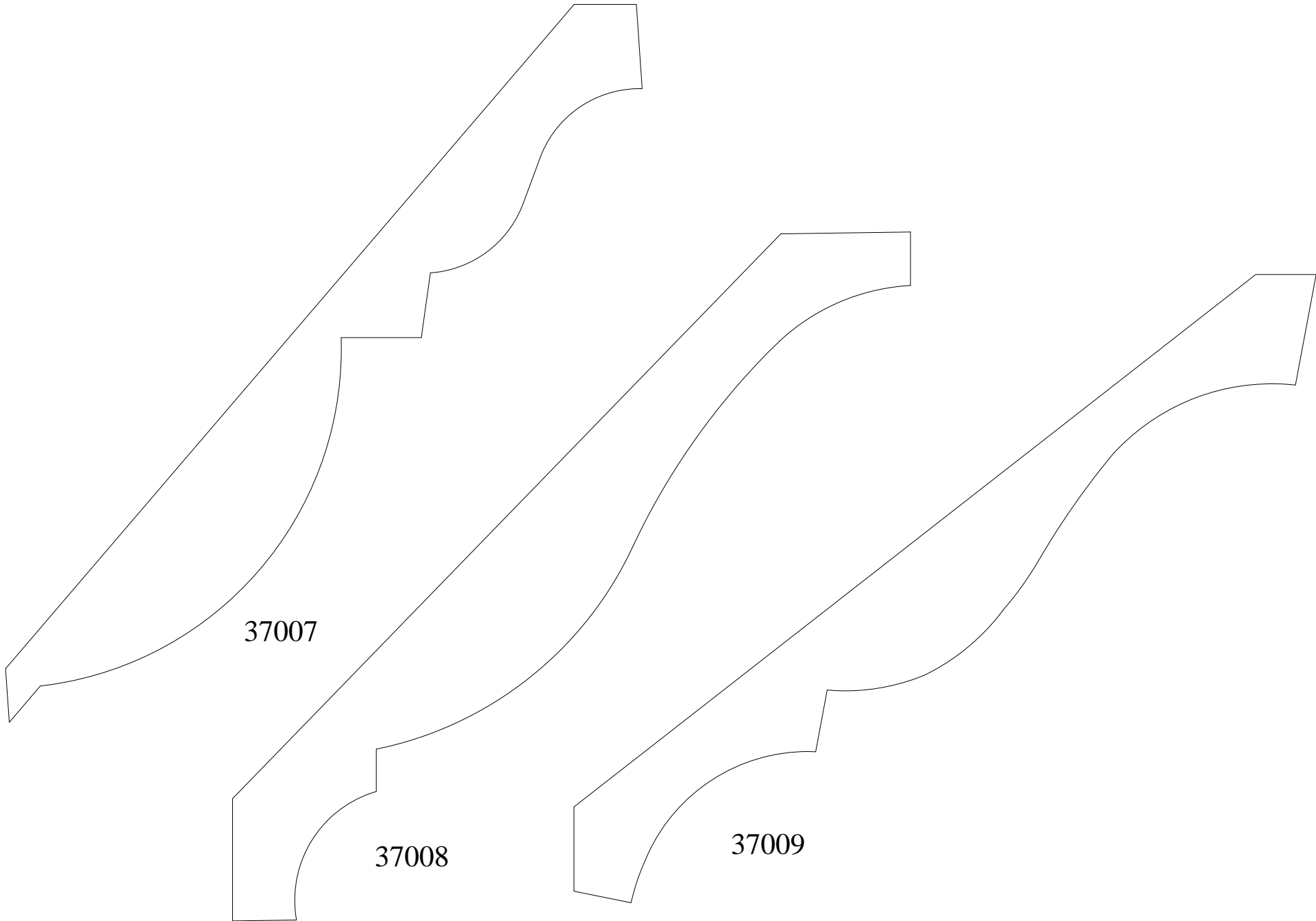

37007

37008

37009

EST. 1879

**S T A R K**

L U M B E R C O M P A N Y

FINE WOOD MOULDING

924 W. 1st. Avenue  
 Denver, CO 80223  
 303-534-8263 Phone  
 303-534-8266 Fax

|              |          |             |
|--------------|----------|-------------|
| Approved by: | MM/DD/YY |             |
| Drawn:       |          |             |
| File name:   |          | Scale 1:1   |
|              |          | Sheet 3-7-3 |

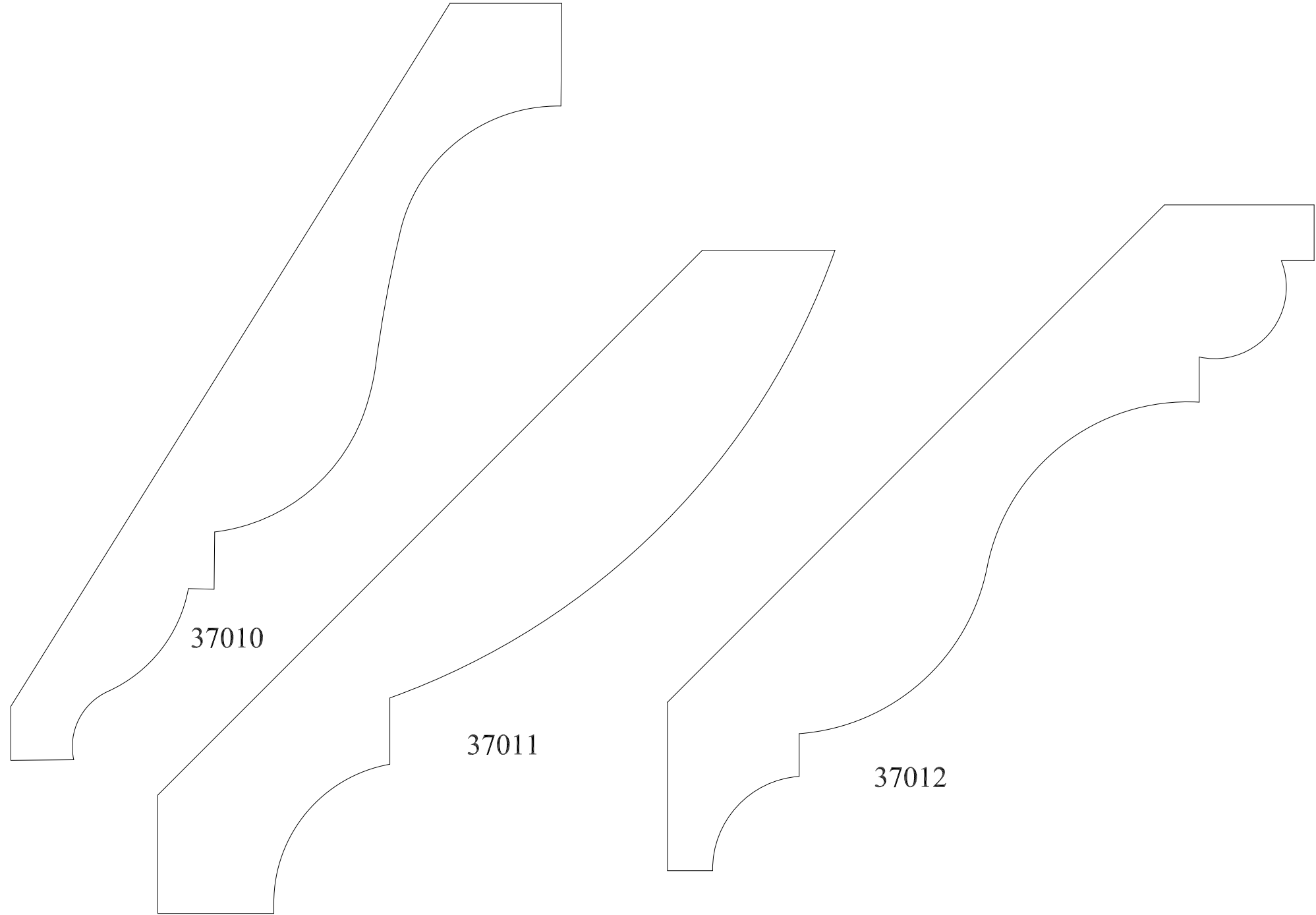

37010

37011

37012

EST. 1879

**S T A R K**

L U M B E R C O M P A N Y

FINE WOOD MOULDING

924 W. 1st. Avenue  
Denver, CO 80223  
303-534-8263  
Phone  
303-534-8266 Fax

|  |
|--|
|  |
|--|

|              |          |
|--------------|----------|
| Approved by: | MM/DD/YY |
| Drawn:       |          |
| File name:   |          |

|           |             |
|-----------|-------------|
| Scale 1:1 | Sheet 3-7-4 |
|-----------|-------------|

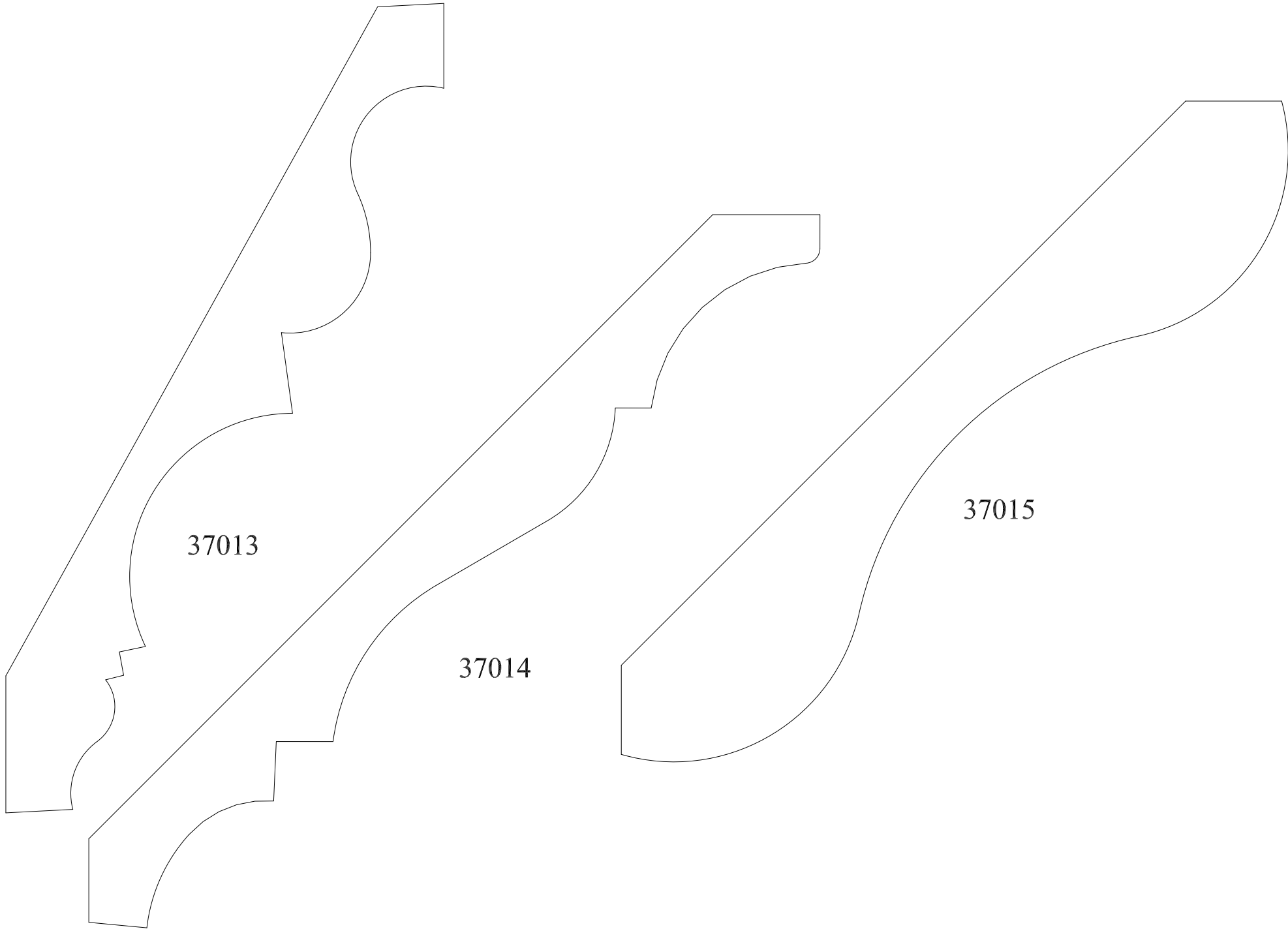

37013

37014

37015

|  |   |
|--|---|
|  | 924 W. 1st. Avenue<br>Denver, CO 80223<br>303-534-8263<br>Phone |
|  | 303-534-8266 Fax  |

|  |
|--|
|  |
|--|

|              |          |
|--------------|----------|
| Approved by: | MM/DD/YY |
| Drawn:       |          |
| File name:   |          |

|           |             |
|-----------|-------------|
| Scale 1:1 | Sheet 3-7-5 |
|-----------|-------------|

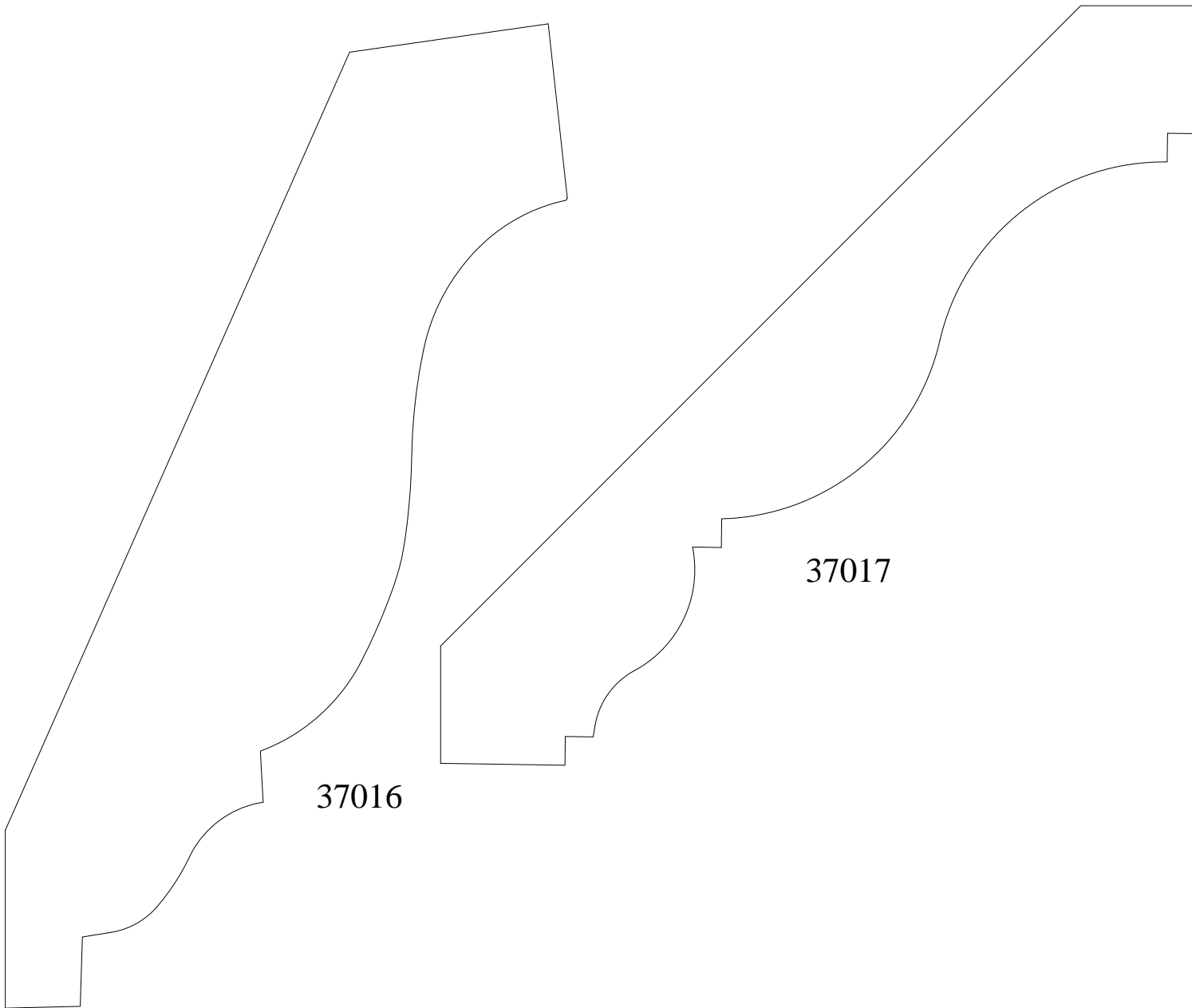

37016

37017

EST. 1879

**S T A R K**

L U M B E R C O M P A N Y

FINE WOOD MOULDING

924 W. 1st. Avenue  
 Denver, CO 80223  
 303-534-8263 Phone  
 303-534-8266 Fax

|              |          |           |             |
|--------------|----------|-----------|-------------|
| Approved by: | MM/DD/YY |           |             |
| Drawn:       |          |           |             |
| File name:   |          | Scale 1:1 | Sheet 3-7-6 |



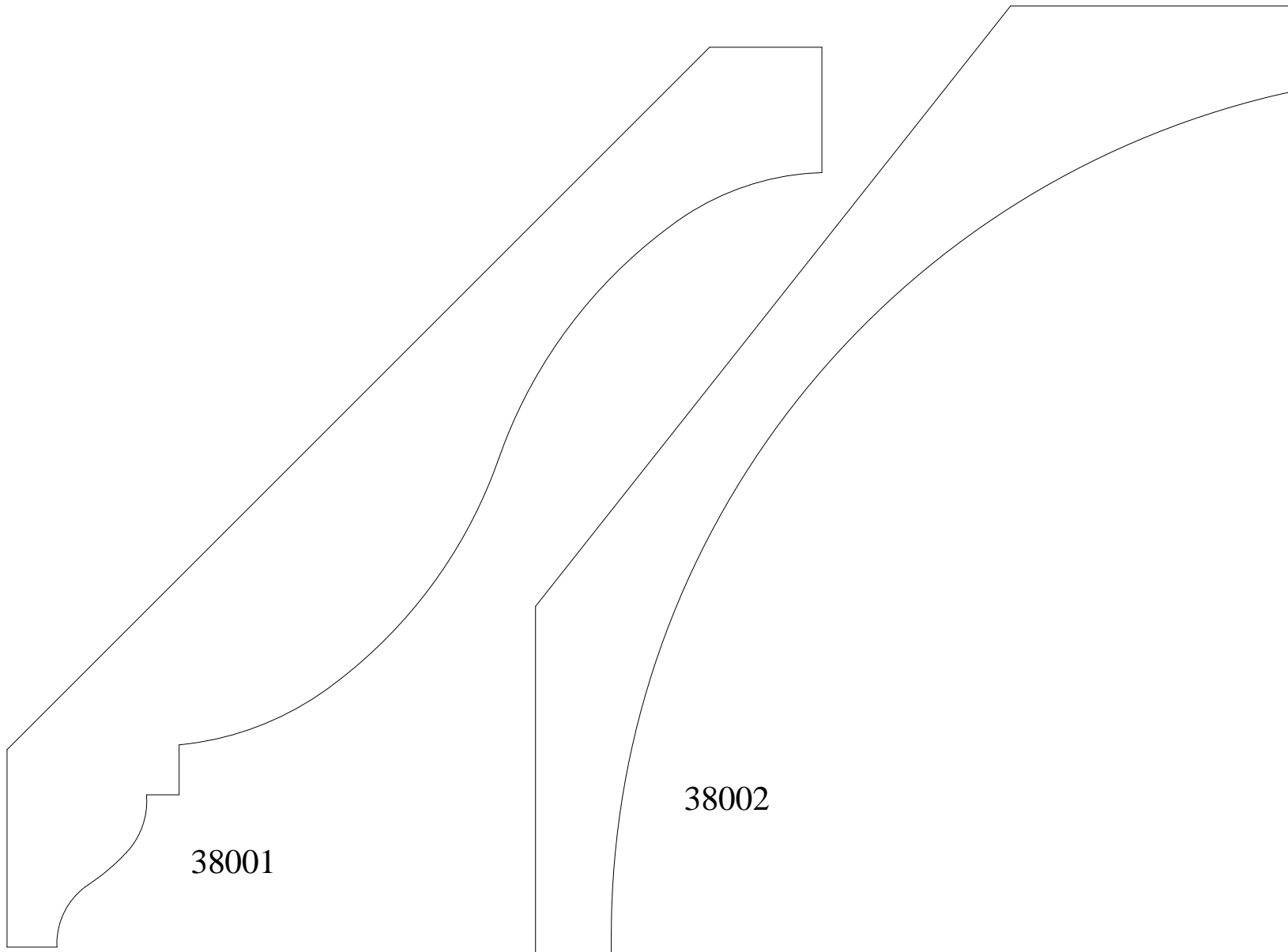

38001

38002

EST. 1879  
**S T A R K**  
L U M B E R C O M P A N Y  
FINE WOOD MOULDING

924 W. 1st. Avenue  
Denver, CO 80223  
303-534-8263 Phone  
303-534-8266 Fax

|              |          |           |             |
|--------------|----------|-----------|-------------|
| Approved by: | MM/DD/YY |           |             |
| Drawn:       |          |           |             |
| File name:   |          | Scale 1:1 | Sheet 3-8-1 |

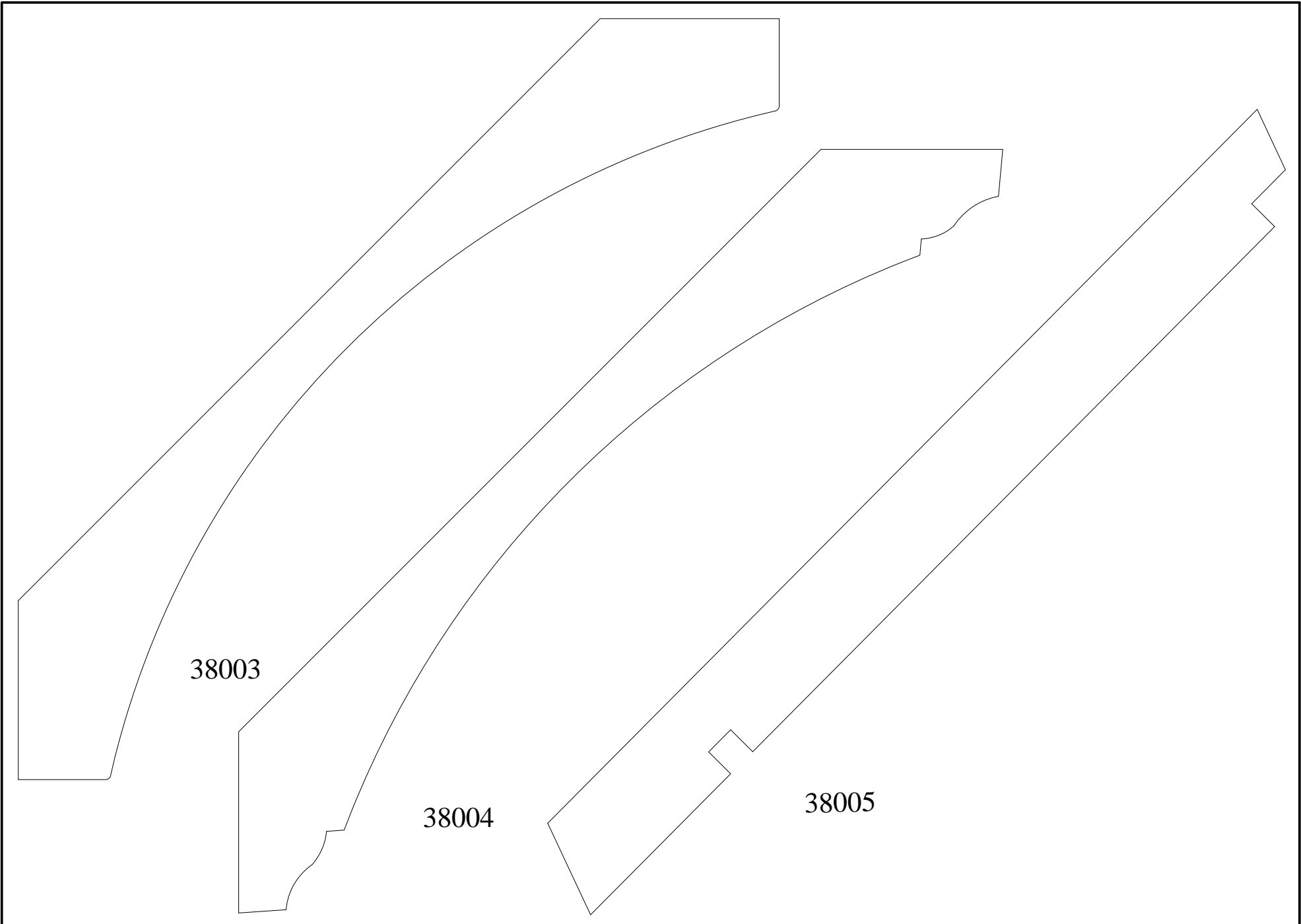

38003

38004

38005

|  |  |
|--|--|
| <small>EST. 1879</small><br><b>S T A R K</b><br>L U M B E R C O M P A N Y<br><small>FINE WOOD MOULDING</small> | 924 W. 1st. Avenue<br>Denver, CO 80223<br>303-534-8263 Phone<br>303-534-8266 Fax |
|--|--|

|  |
|--|
|  |
|--|

|              |          |
|--------------|----------|
| Approved by: | MM/DD/YY |
| Drawn:       |          |
| File name:   |          |

|           |             |
|-----------|-------------|
| Scale 1:1 | Sheet 3-8-2 |
|-----------|-------------|

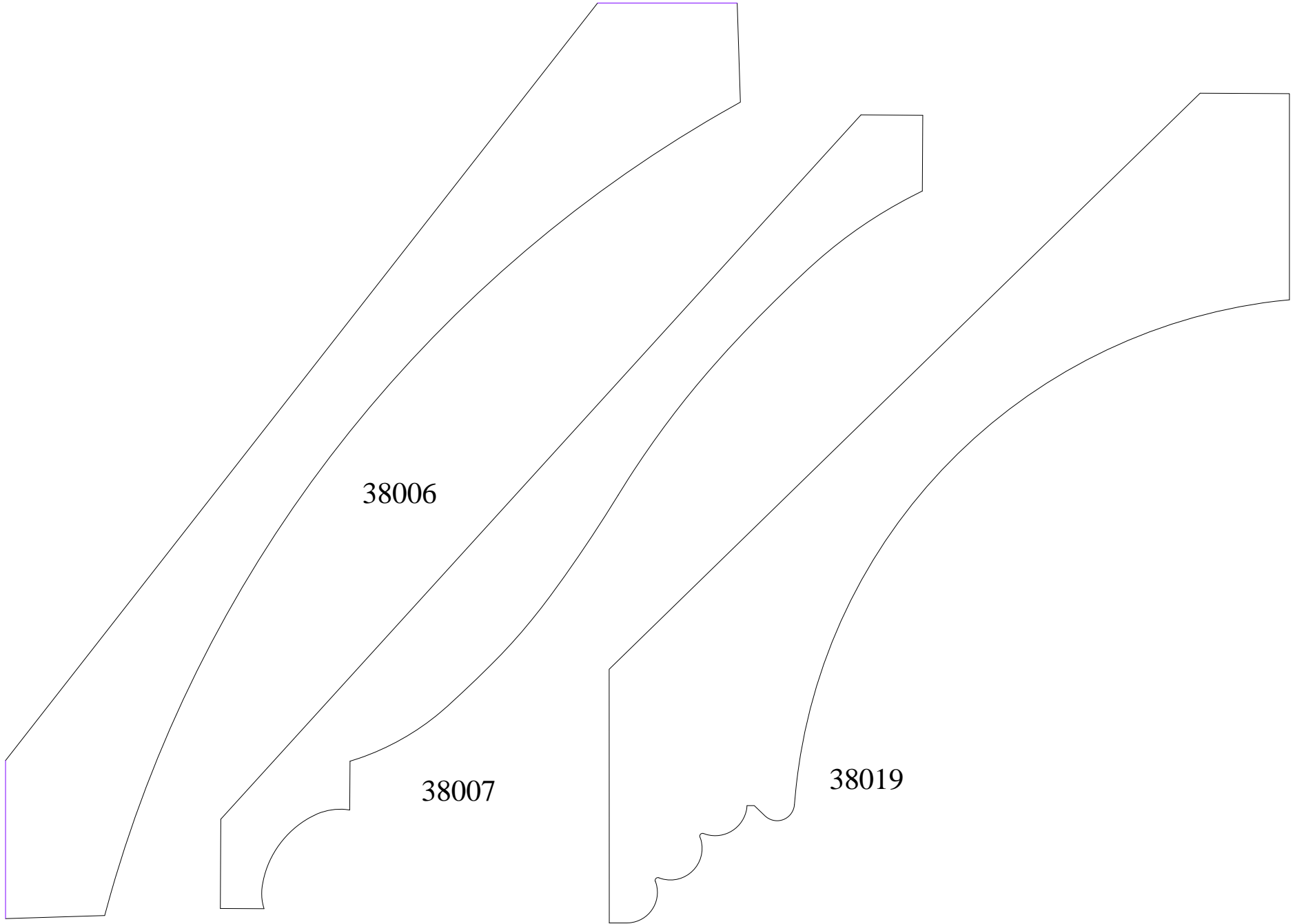

38006

38007

38019

|   |  |              |  |           |             |
|---|--|--------------|--|-----------|-------------|
| <p>EST. 1879</p> <p><b>S T A R K</b></p> <p>L U M B E R C O M P A N Y</p> <p>FINE WOOD MOULDING</p> | <p>924 W. 1st. Avenue<br/>Denver, CO 80223<br/>303-534-8263 Phone<br/>303-534-8266 Fax</p> | Approved by: |  | MM/DD/YY  |             |
|   |  | Drawn:       |  |           |             |
|   |  | File name:   |  | Scale 1:1 | Sheet 3-8-3 |

|              |  |           |             |
|--------------|--|-----------|-------------|
| Approved by: |  | MM/DD/YY  |             |
| Drawn:       |  |           |             |
| File name:   |  | Scale 1:1 | Sheet 3-8-3 |

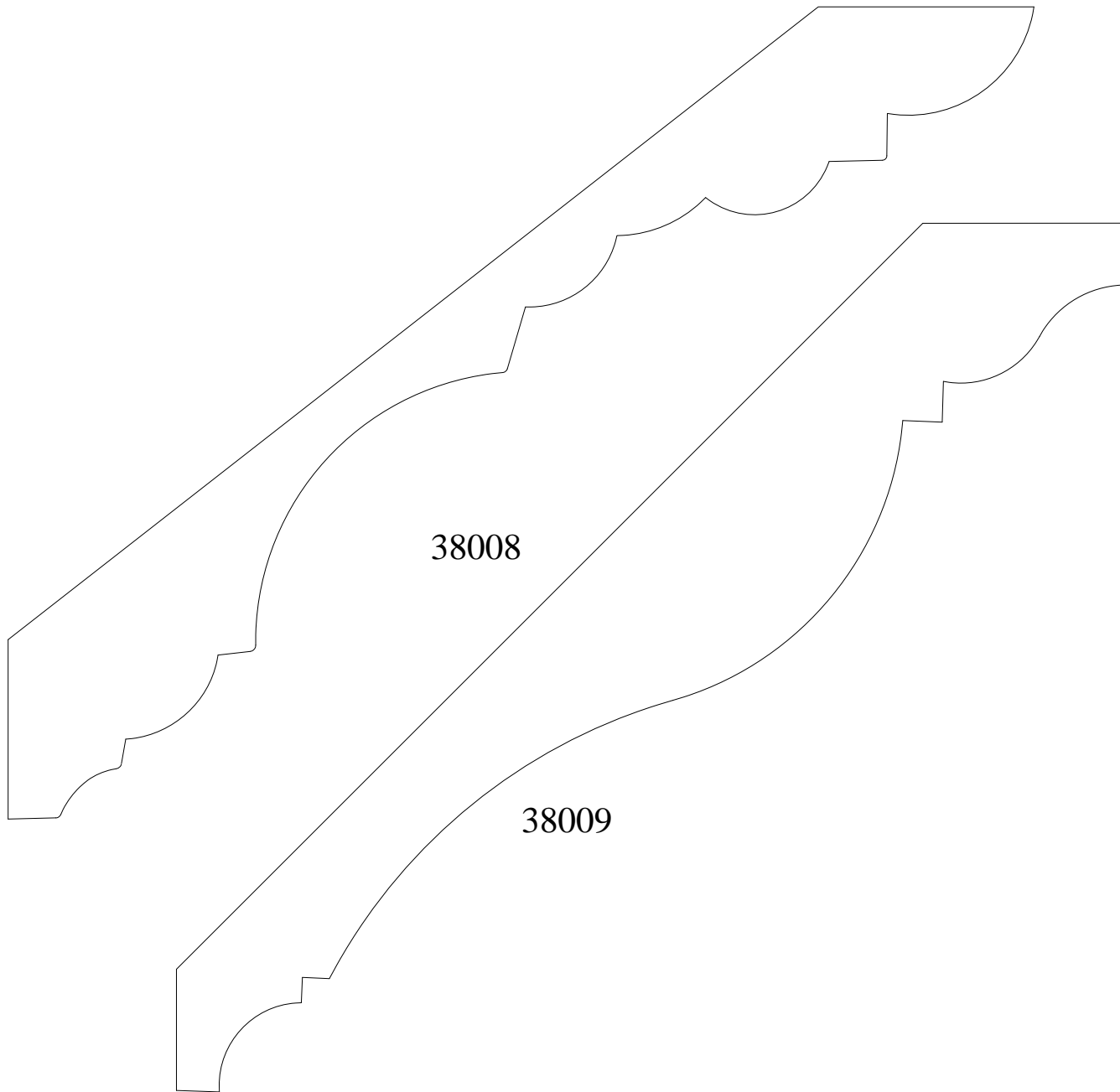

38008

38009

EST. 1879  
**S T A R K**  
L U M B E R C O M P A N Y  
FINE WOOD MOULDING

924 W. 1st. Avenue  
Denver, CO 80223  
303-534-8263 Phone  
303-534-8266 Fax

|              |          |             |
|--------------|----------|-------------|
| Approved by: | MM/DD/YY |             |
| Drawn:       |          |             |
| File name:   |          | Scale 1:1   |
|              |          | Sheet 3-8-4 |

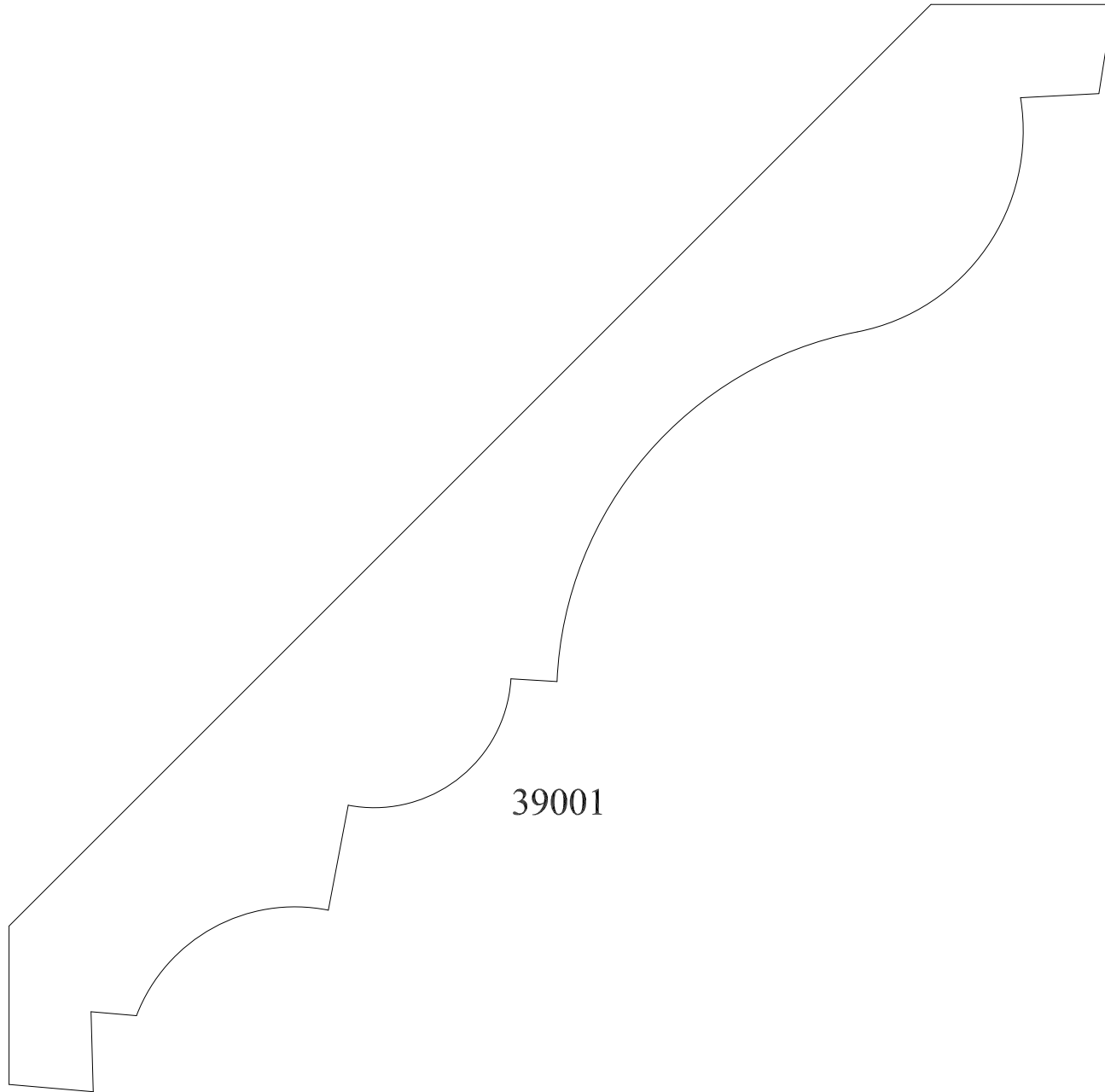

39001

|   |   |
|---|---|
|  <p><b>S T A R K</b><br/>L U M B E R C O M P A N Y<br/>FINE WOOD MOULDING</p> | 924 W. 1st. Avenue<br>Denver, CO 80223<br>303-534-8263<br>Phone |
|   | 303-534-8266 Fax  |

|  |
|--|
|  |
|--|

|              |          |
|--------------|----------|
| Approved by: | MM/DD/YY |
| Drawn:       |          |
| File name:   |          |

|           |             |
|-----------|-------------|
| Scale 1:1 | Sheet 3-9-1 |
|-----------|-------------|

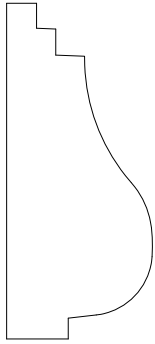

41001

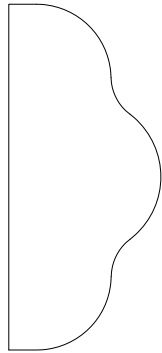

41004

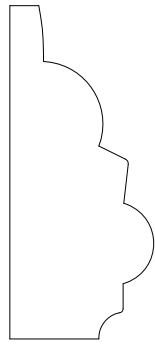

41007

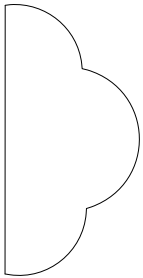

41002

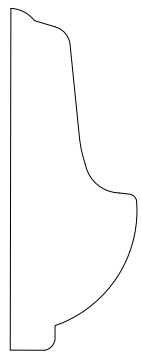

41005

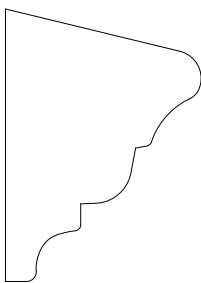

41008

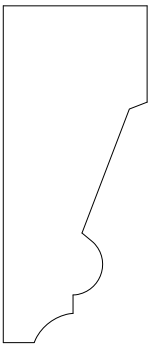

41003

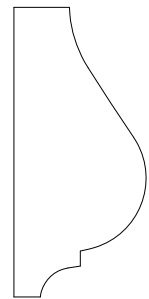

41006

EST. 1879

**S T A R K**

L U M B E R C O M P A N Y

FINE WOOD MOULDING

924 W. 1st. Avenue  
 Denver, CO 80223  
 303-534-8263 Phone  
 303-534-8266 Fax

|              |          |             |
|--------------|----------|-------------|
| Approved by: | MM/DD/YY |             |
| Drawn:       |          |             |
| File name:   |          | Scale 1:1   |
|              |          | Sheet 4-1-1 |

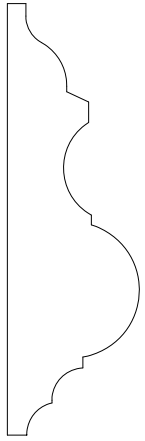

42001

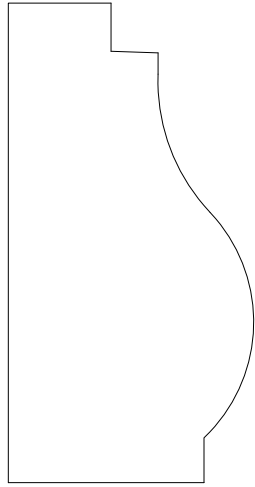

42003

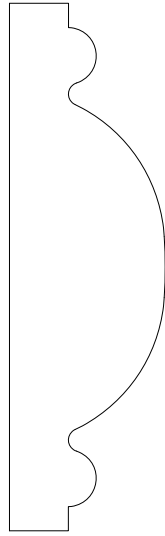

42005

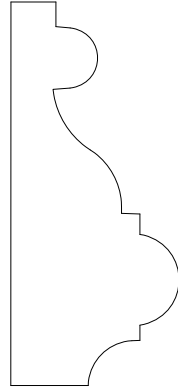

42007

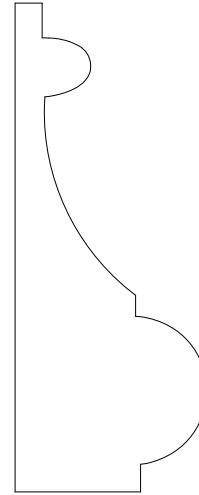

42009

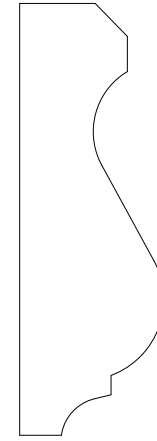

42011

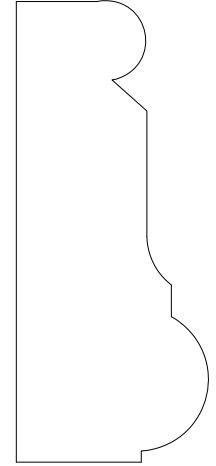

42013

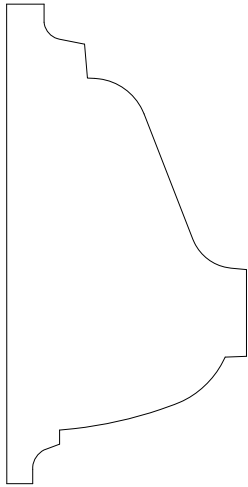

42002

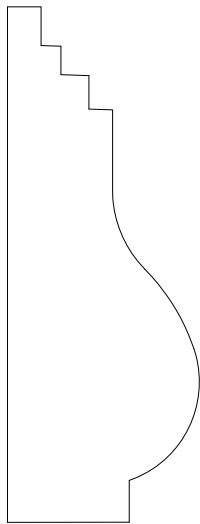

42004

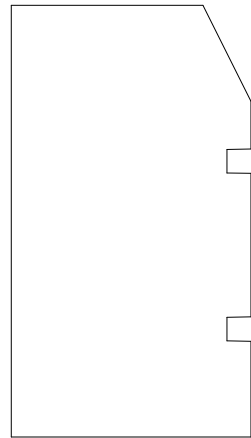

42006



42008

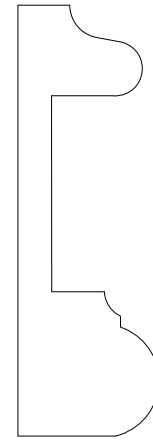

42010

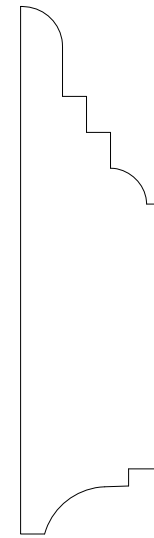

42012

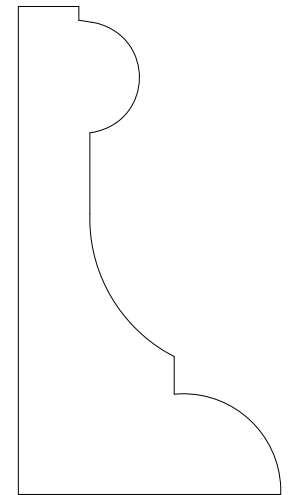

42014

EST. 1879

**S T A R K**

L U M B E R C O M P A N Y

FINE WOOD MOULDING

924 W. 1st. Avenue  
 Denver, CO 80223  
 303-534-8263 Phone  
 303-534-8266 Fax

|              |          |             |
|--------------|----------|-------------|
| Approved by: | MM/DD/YY |             |
| Drawn:       |          |             |
| File name:   |          | Scale 1:1   |
|              |          | Sheet 4-2-1 |

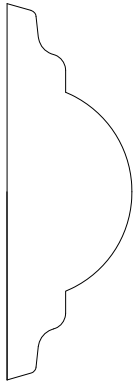

42015

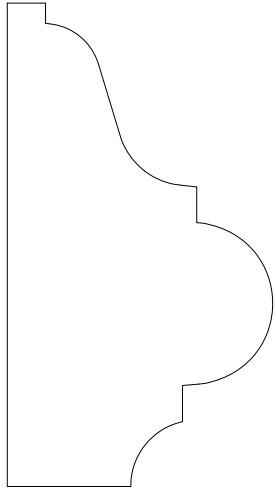

42017

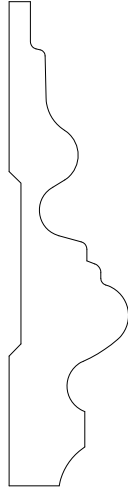

42019

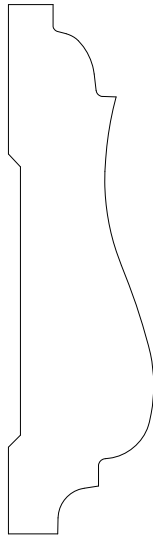

42021

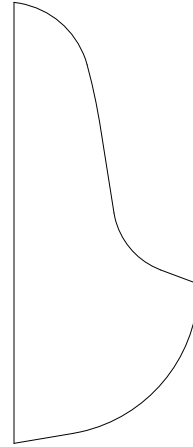

42023

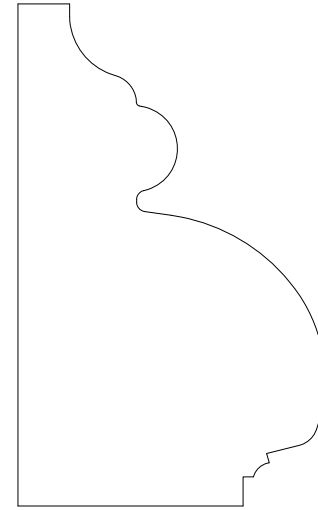

42025

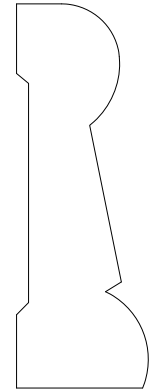

42027

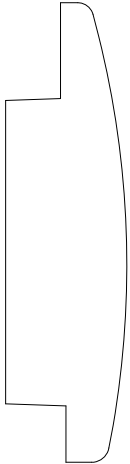

42016

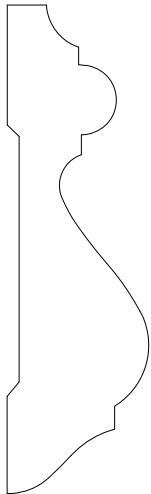

42018

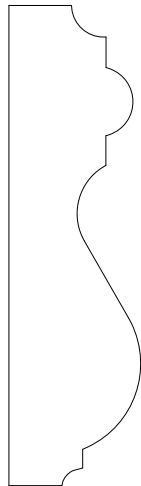

42020

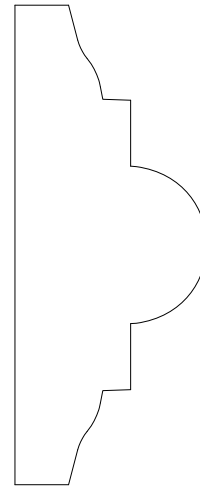

42024

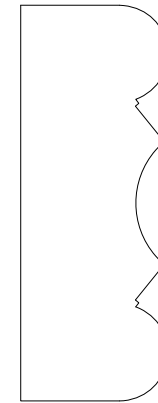

42026

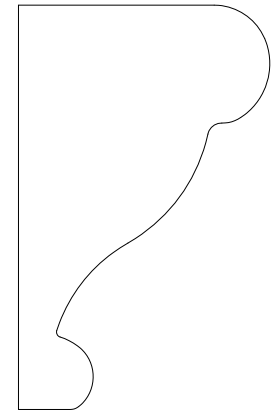

42028



EST. 1879  
924 W. 1st. Avenue  
Denver, CO 80223  
303-534-8263 Phone  
303-534-8266 Fax

|              |          |
|--------------|----------|
| Approved by: | MM/DD/YY |
| Drawn:       |          |
| File name:   |          |

Scale 1:1 Sheet 4-2-2



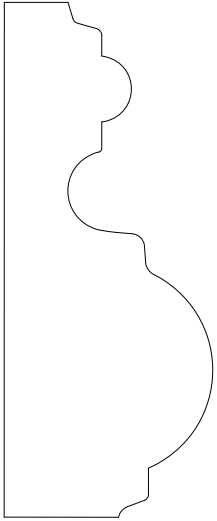

42029

|   |  |              |          |           |             |
|---|--|--------------|----------|-----------|-------------|
|  <p>EST. 1879<br/><b>S T A R K</b><br/>L U M B E R C O M P A N Y<br/>FINE WOOD MOULDING</p> | 924 W. 1st. Avenue<br>Denver, CO 80223<br>303-534-8263 Phone<br>303-534-8266 Fax | Approved by: | MM/DD/YY |           |             |
|   |  | Drawn:       |          |           |             |
|   |  | File name:   |          | Scale 1:1 | Sheet 4-2-3 |



43001

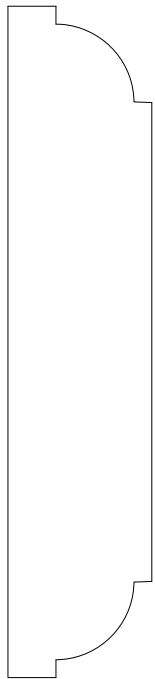

43003

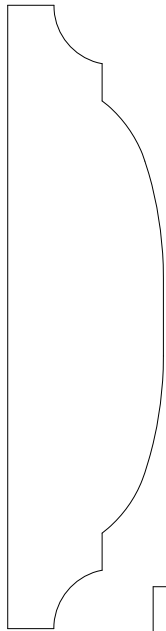

43005

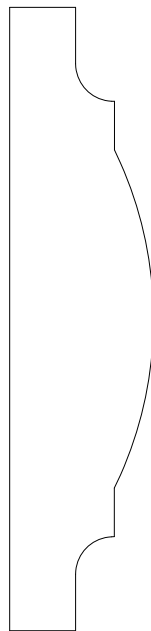

43007

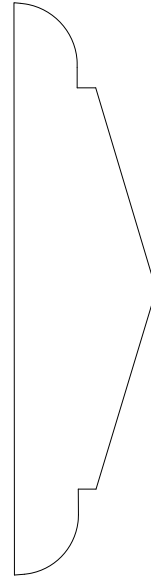

43009

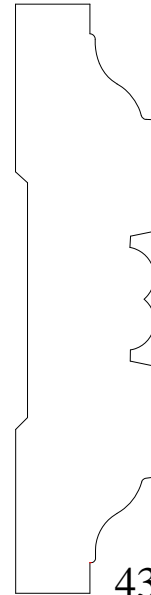

43011

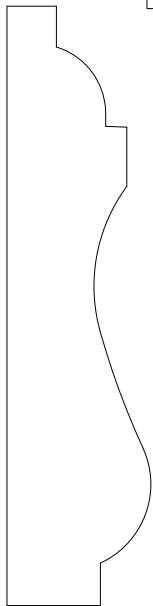

43002

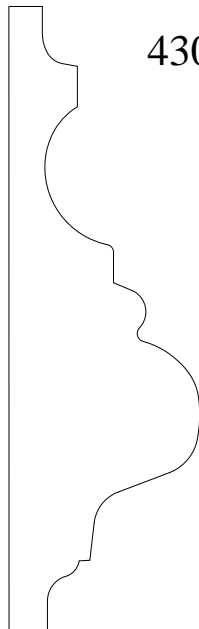

43004

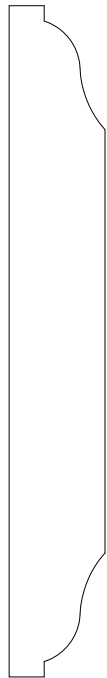

43006

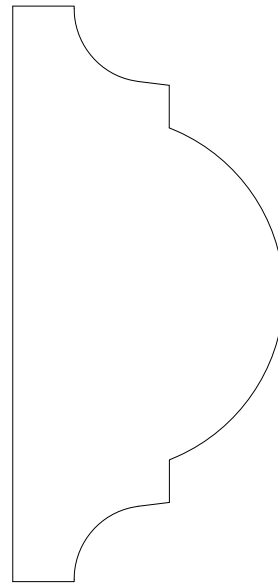

43008

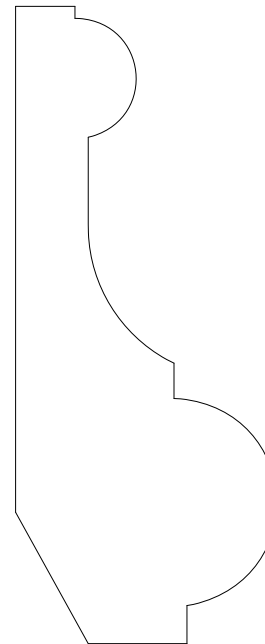

43010

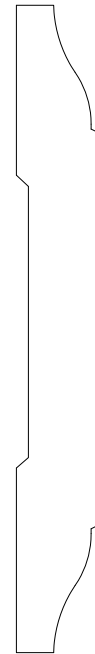

43012

EST. 1879

**S T A R K**

L U M B E R C O M P A N Y

FINE WOOD MOULDING

924 W. 1st. Avenue  
 Denver, CO 80223  
 303-534-8263 Phone  
 303-534-8266 Fax

|              |          |             |
|--------------|----------|-------------|
| Approved by: | MM/DD/YY |             |
| Drawn:       |          |             |
| File name:   |          | Scale 1:1   |
|              |          | Sheet 4-3-1 |

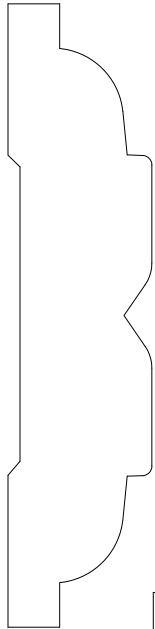

43013

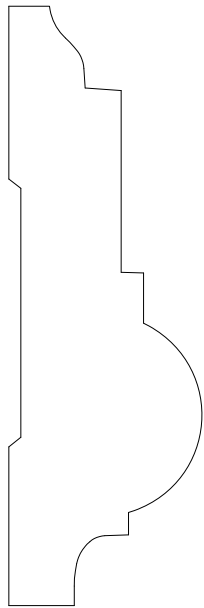

43015

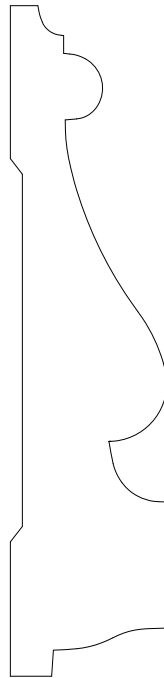

43017

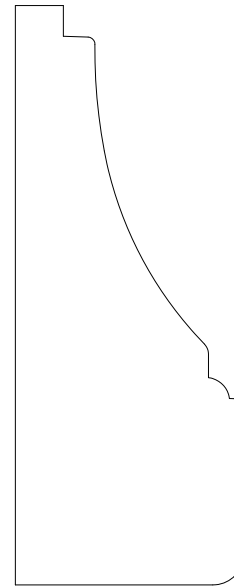

43019

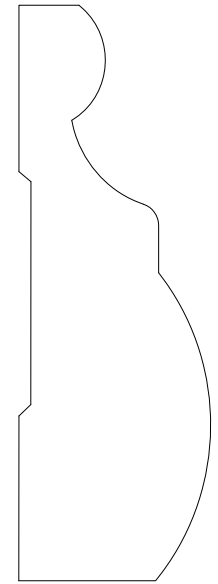

43021

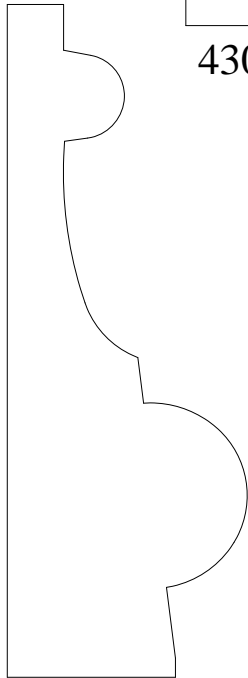

43014

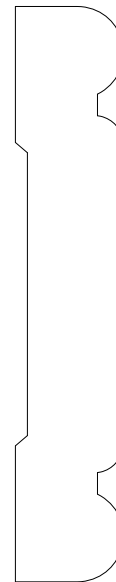

43018

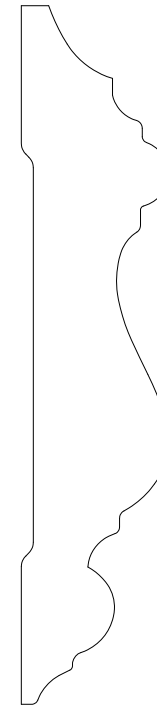

43020

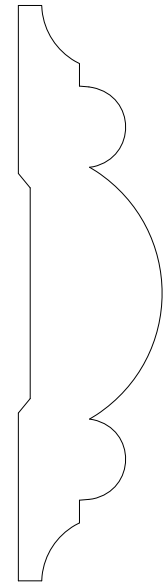

43022

EST. 1879

**S T A R K**

L U M B E R C O M P A N Y

FINE WOOD MOULDING

924 W. 1st. Avenue  
 Denver, CO 80223  
 303-534-8263 Phone  
 303-534-8266 Fax

|              |          |                       |
|--------------|----------|-----------------------|
| Approved by: | MM/DD/YY |                       |
| Drawn:       |          |                       |
| File name:   |          | Scale 1:1 Sheet 4-3-2 |

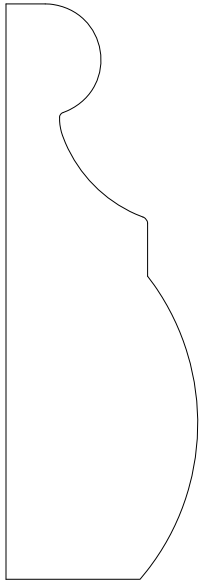

43023

|   |  |              |          |           |             |
|---|--|--------------|----------|-----------|-------------|
|  <p><b>S T A R K</b><br/>L U M B E R C O M P A N Y<br/>FINE WOOD MOULDING</p> | 924 W. 1st. Avenue<br>Denver, CO 80223<br>303-534-8263 Phone<br>303-534-8266 Fax | Approved by: | MM/DD/YY |           |             |
|   |  | Drawn:       |          |           |             |
|   |  | File name:   |          | Scale 1:1 | Sheet 4-3-3 |

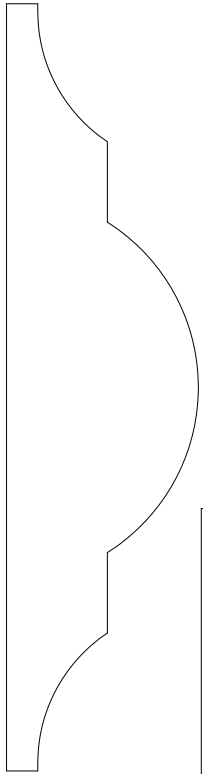

44001

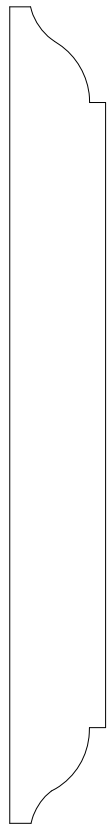

44003

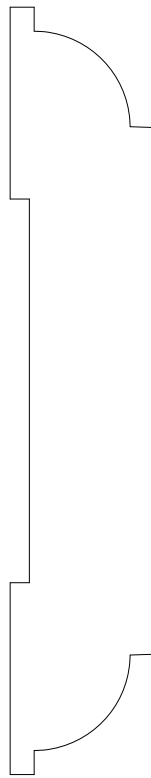

44005

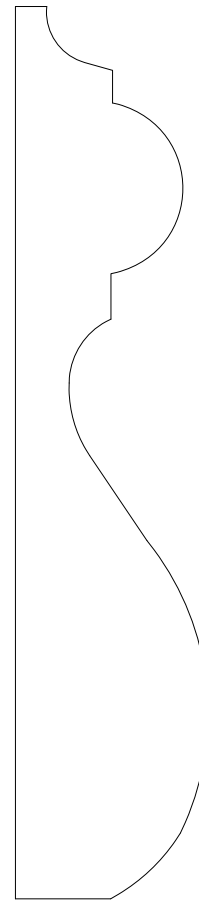

44007

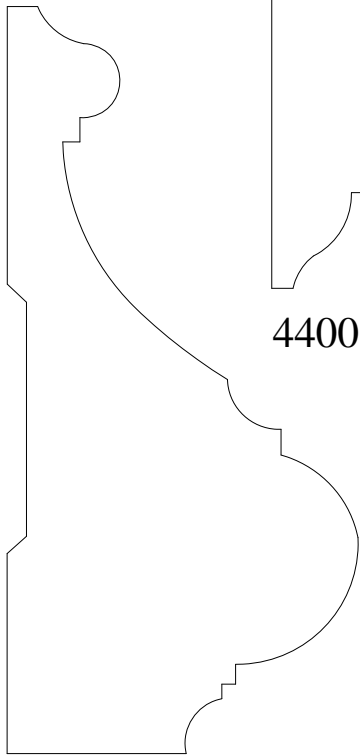

44002

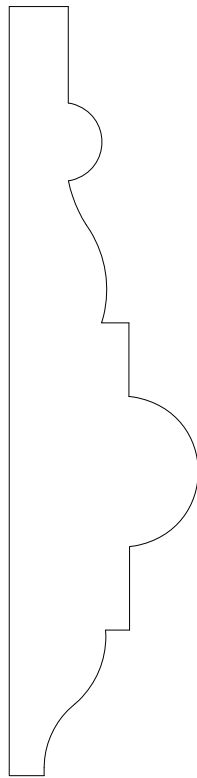

44004

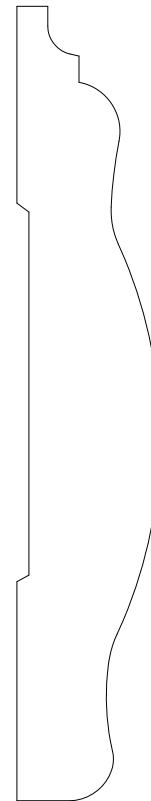

44006

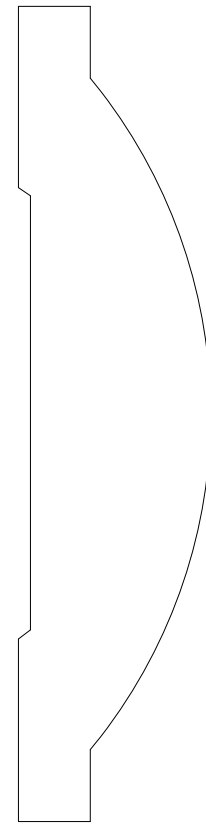

44008

EST. 1879

**S T A R K**

L U M B E R C O M P A N Y

FINE WOOD MOULDING

924 W. 1st. Avenue  
 Denver, CO 80223  
 303-534-8263 Phone  
 303-534-8266 Fax

|              |          |           |             |
|--------------|----------|-----------|-------------|
| Approved by: | MM/DD/YY |           |             |
| Drawn:       |          |           |             |
| File name:   |          | Scale 1:1 | Sheet 4-4-1 |

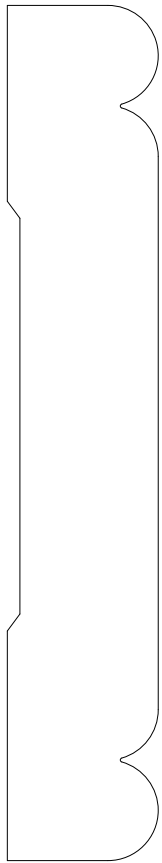

44009

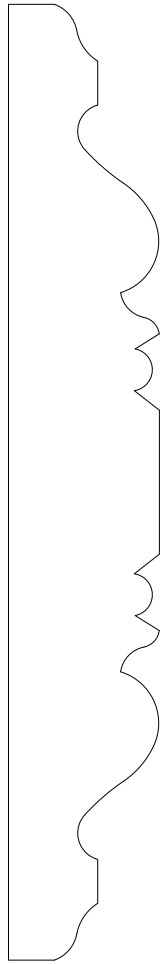

44010

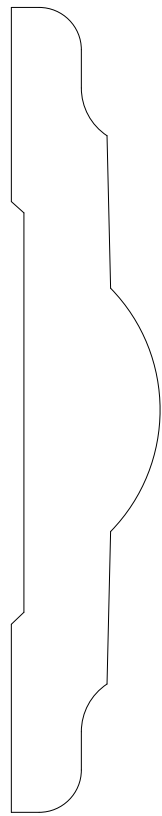

44011

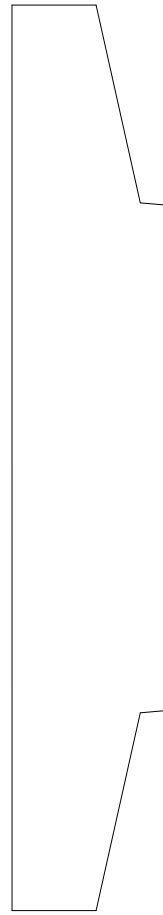

44012

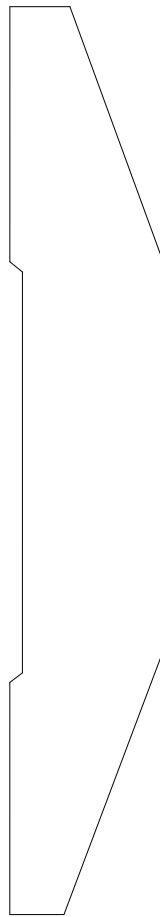

44013



44014

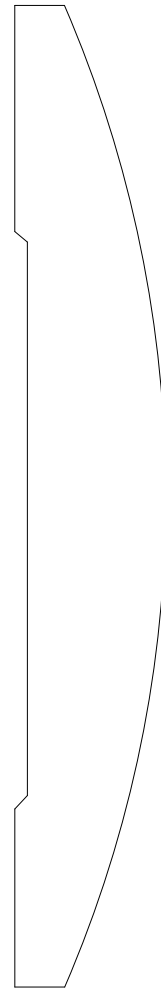

44015

|  |   |
|--|---|
|  | 924 W. 1st. Avenue<br>Denver, CO 80223<br>303-534-8263<br>Phone |
|  | 303-534-8266 Fax  |

|  |
|--|
|  |
|--|

|              |          |
|--------------|----------|
| Approved by: | MM/DD/YY |
| Drawn:       |          |
| File name:   |          |

|           |             |
|-----------|-------------|
| Scale 1:1 | Sheet 4-4-2 |
|-----------|-------------|

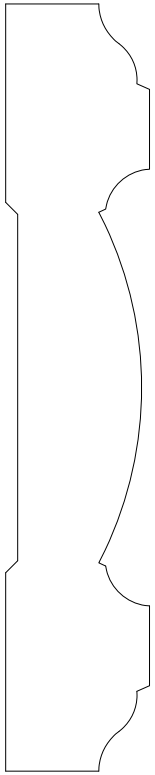

44017

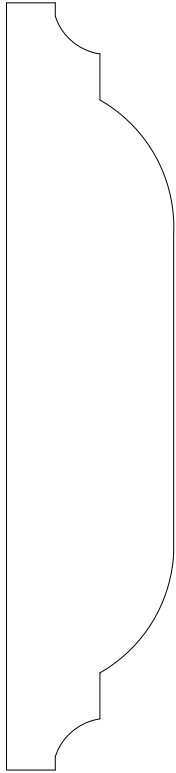

44019



44018

EST. 1879

**S T A R K**

L U M B E R C O M P A N Y

FINE WOOD MOULDING

924 W. 1st. Avenue  
 Denver, CO 80223  
 303-534-8263 Phone  
 303-534-8266 Fax

|              |          |           |             |
|--------------|----------|-----------|-------------|
| Approved by: | MM/DD/YY |           |             |
| Drawn:       |          |           |             |
| File name:   |          | Scale 1:1 | Sheet 4-4-3 |

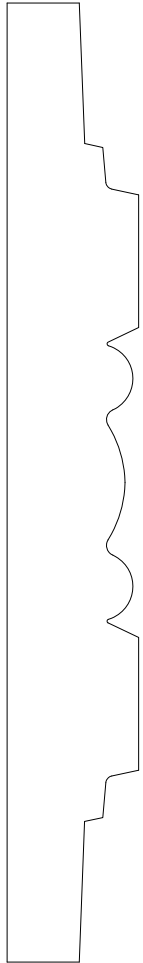

45001

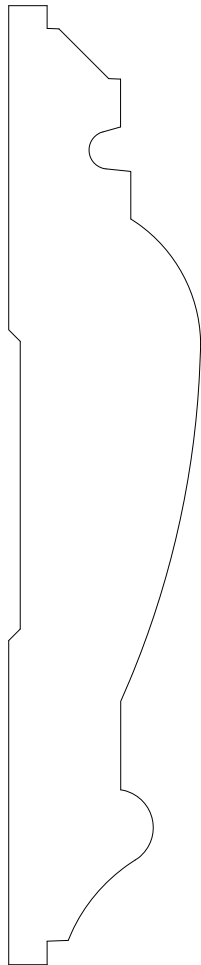

45002

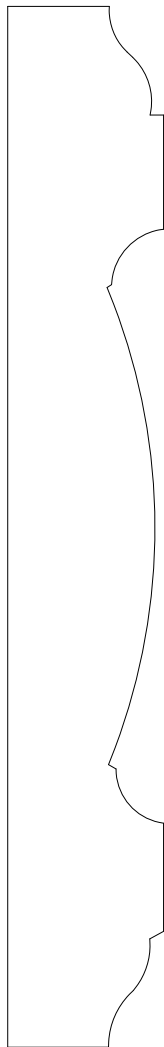

45003

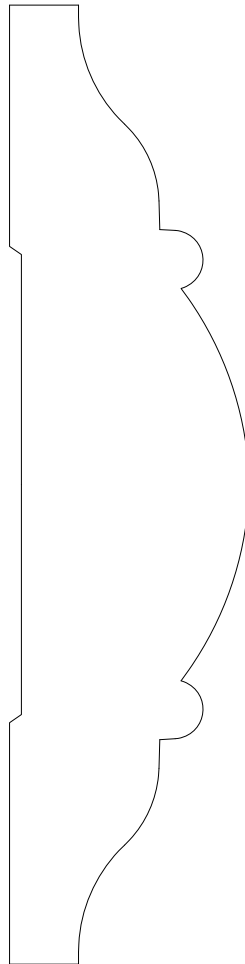

45004

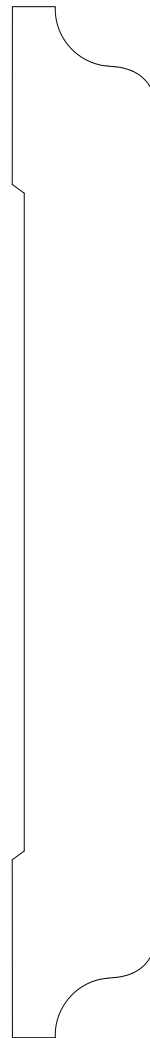

45005

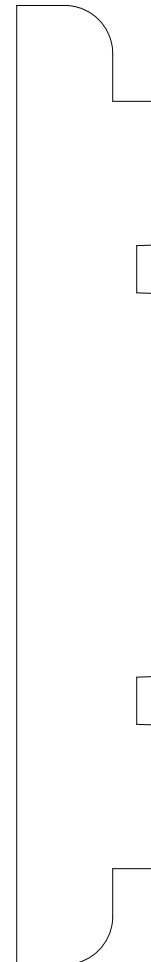

45006

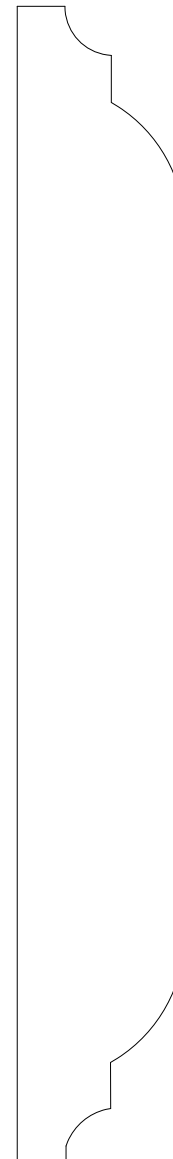

46008

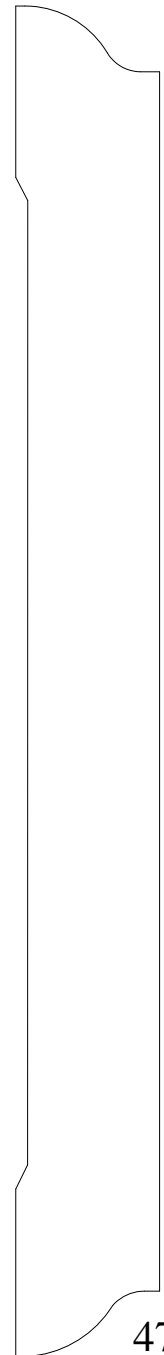

47001

EST. 1879

**S T A R K**

L U M B E R C O M P A N Y

FINE WOOD MOULDING

924 W. 1st. Avenue  
 Denver, CO 80223  
 303-534-8263 Phone  
 303-534-8266 Fax

|              |          |             |
|--------------|----------|-------------|
| Approved by: | MM/DD/YY |             |
| Drawn:       |          |             |
| File name:   |          | Scale 1:1   |
|              |          | Sheet 4-5-1 |



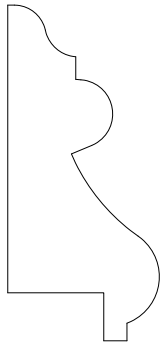

51001

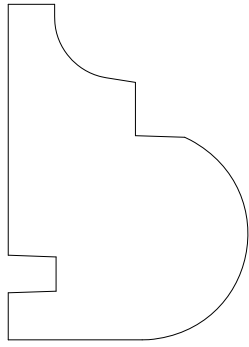

51004

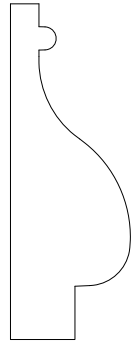

51007

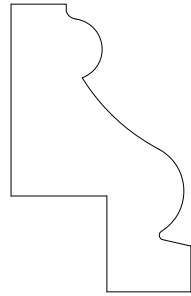

51010

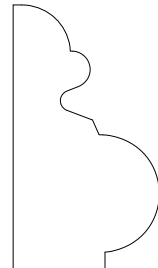

51013

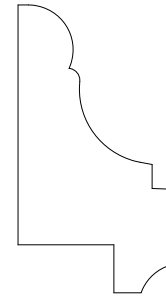

51016

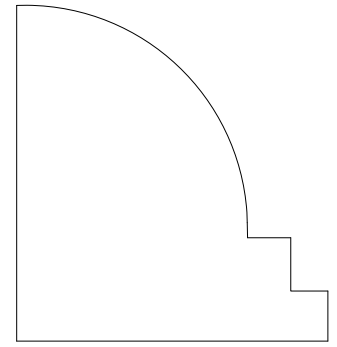

51019

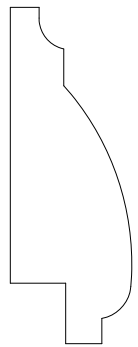

51002



51005

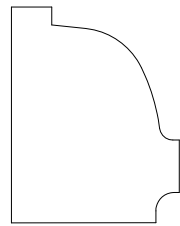

51008

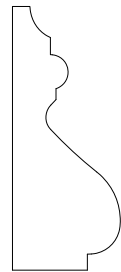

51011

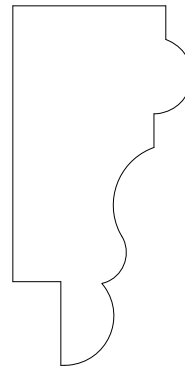

51014

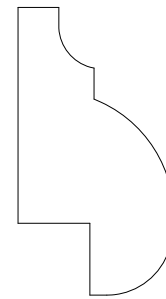

51017

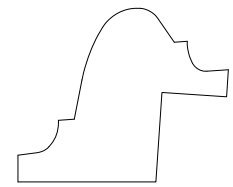

51020

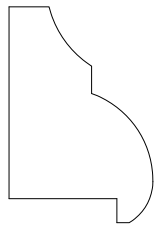

51003

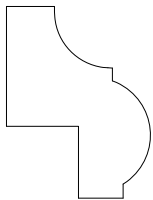

51006

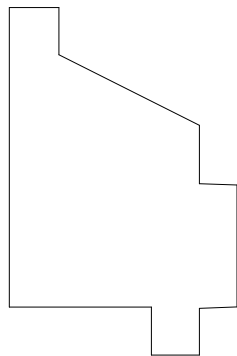

51009

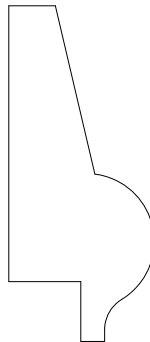

51012

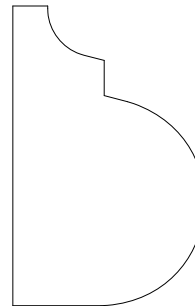

51015

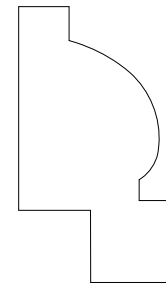

51018

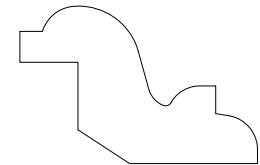

51021

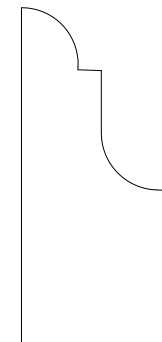

51022

EST. 1879

**S T A R K**

L U M B E R C O M P A N Y

FINE WOOD MOULDING

924 W. 1st. Avenue  
 Denver, CO 80223  
 303-534-8263 Phone  
 303-534-8266 Fax

|              |          |             |
|--------------|----------|-------------|
| Approved by: | MM/DD/YY |             |
| Drawn:       |          |             |
| File name:   |          | Scale 1:1   |
|              |          | Sheet 5-1-1 |

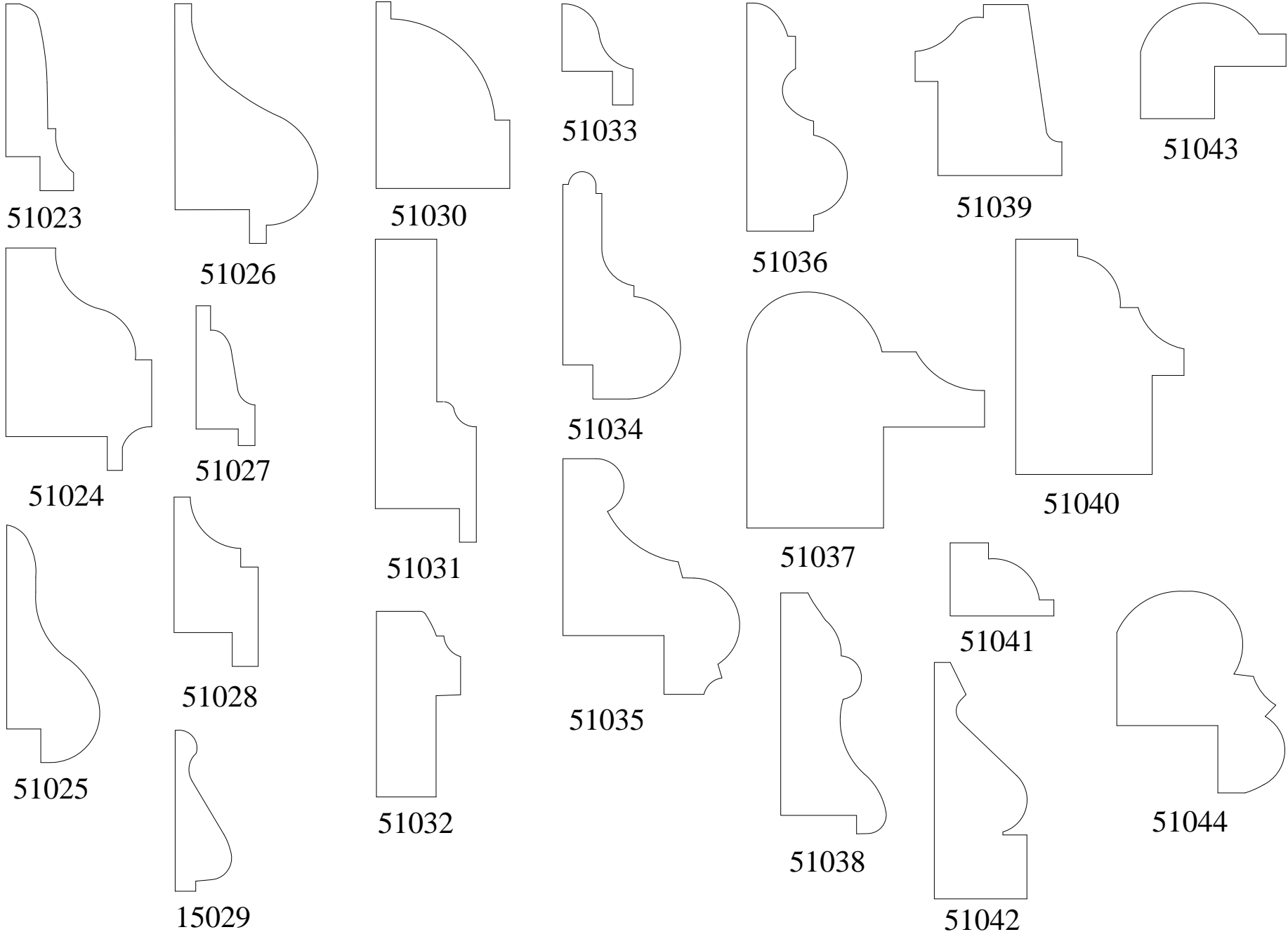

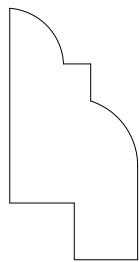

51045

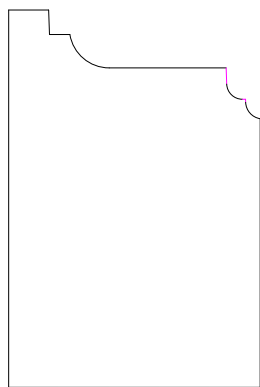

51049

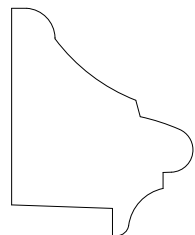

51052

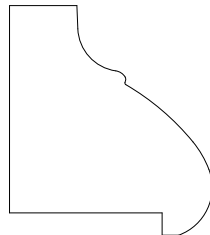

51054

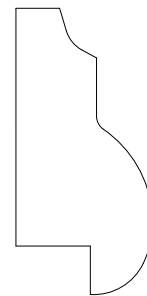

51058

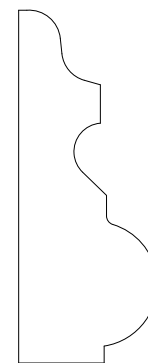

51061

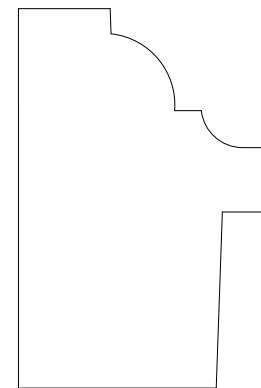

51065

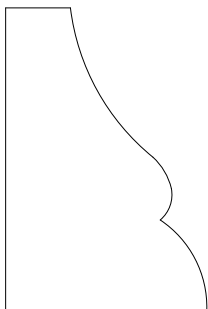

51046

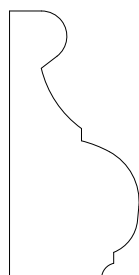

51050

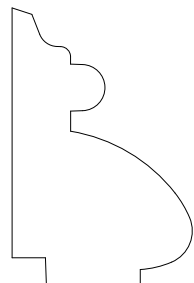

51053

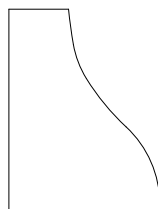

51055

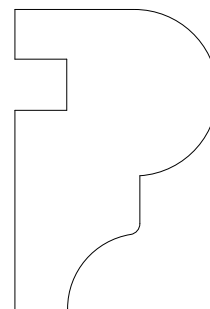

51059



51062

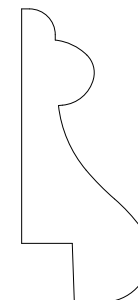

51066

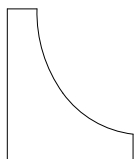

51047

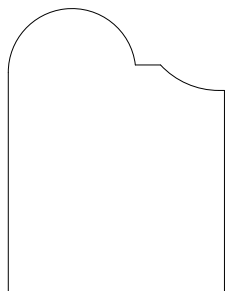

51051

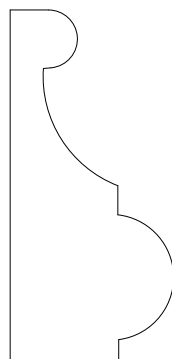
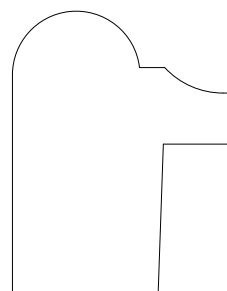

51056

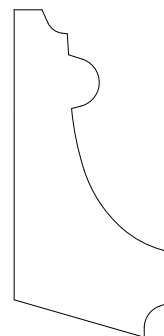

51060

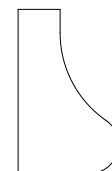

51063

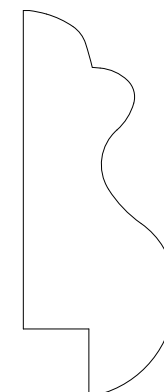

51067

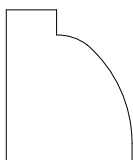

51048

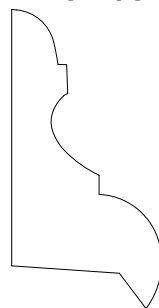

51057



51064

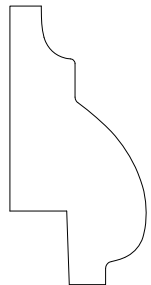

51068

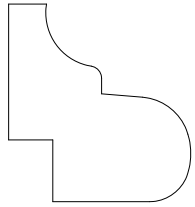

51069

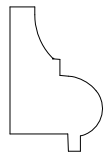

51070

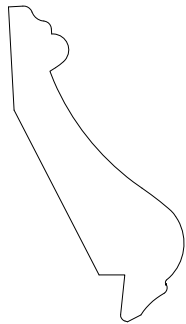

51071

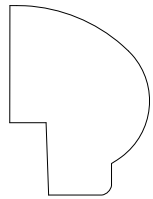

51072

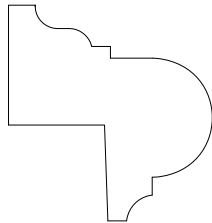

51073

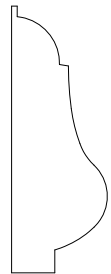

51074

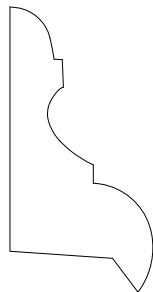

51075

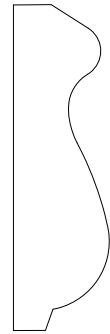

51076

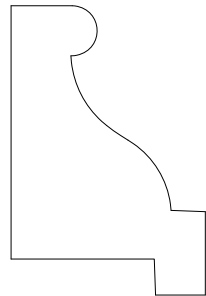

51077

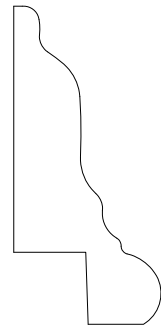

51078

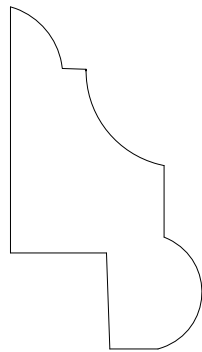

51079

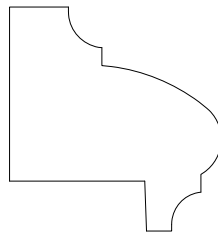

51080

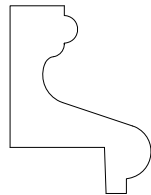

51081

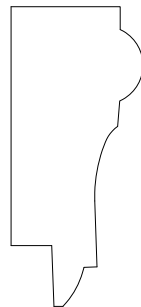

51084

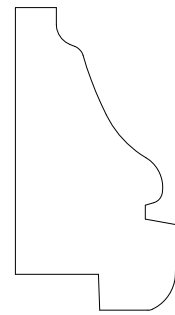

51082

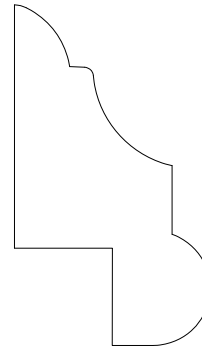

51083

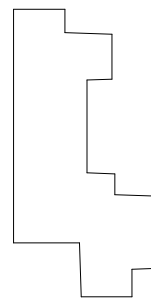

51085

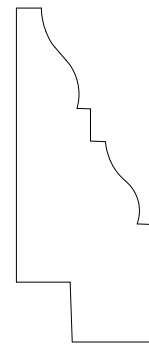

51086

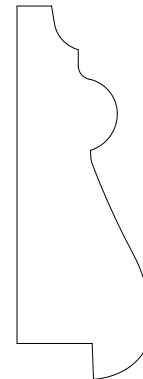

51087

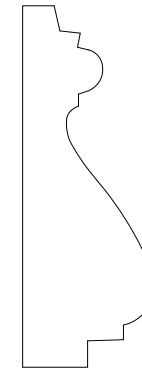

51088

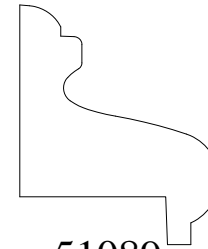

51089

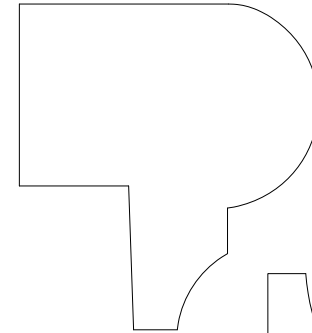

51090

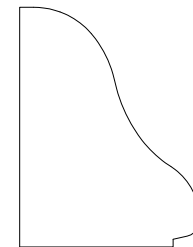

51093

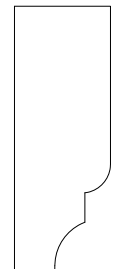

51091

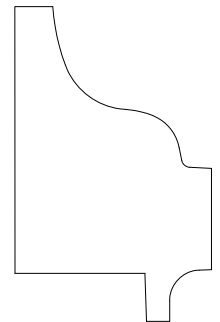

51092

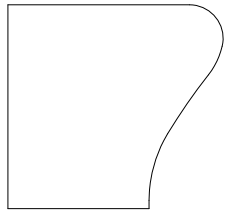

51094

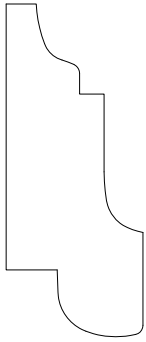

51098

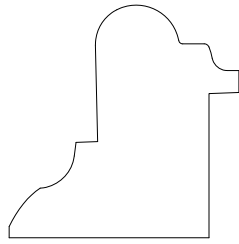

51101

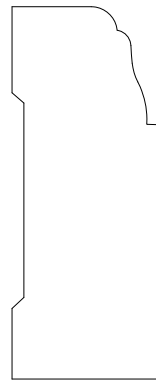

51103



51107

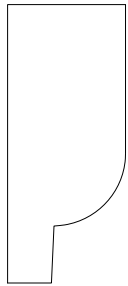

51095

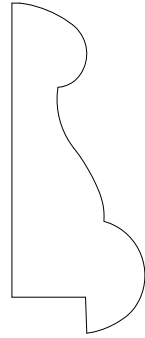

51099

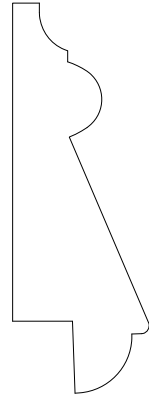

15102

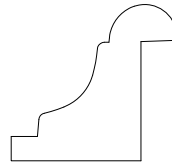

51105



51096

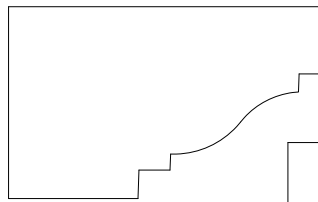

51100

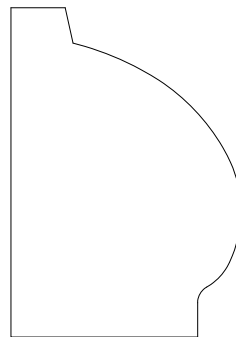

51106

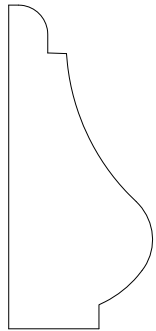

51097

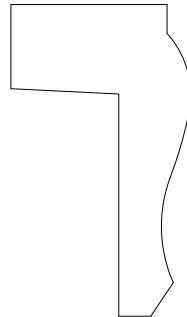

51104

EST. 1879

**S T A R K**

L U M B E R C O M P A N Y

FINE WOOD MOULDING

924 W. 1st. Avenue  
 Denver, CO 80223  
 303-534-8263 Phone  
 303-534-8266 Fax

|              |          |           |             |
|--------------|----------|-----------|-------------|
| Approved by: | MM/DD/YY |           |             |
| Drawn:       |          |           |             |
| File name:   |          | Scale 1:1 | Sheet 5-1-5 |

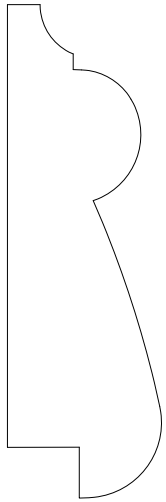

52001

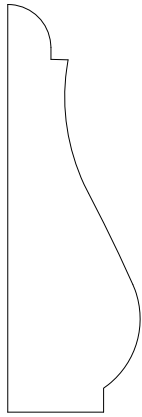

52003

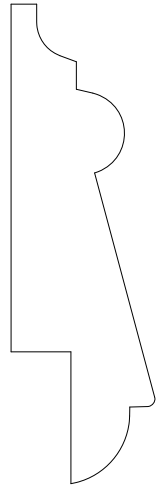

52005

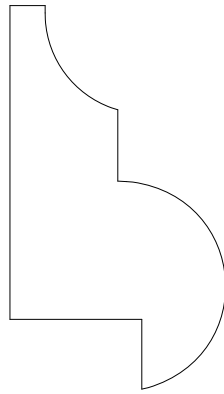

52007

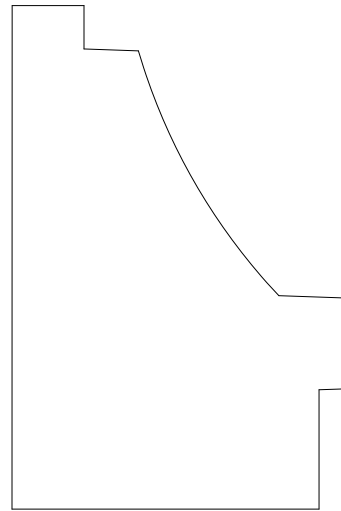

52009

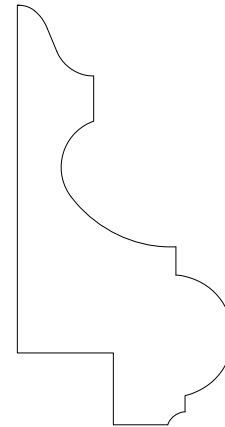

52011

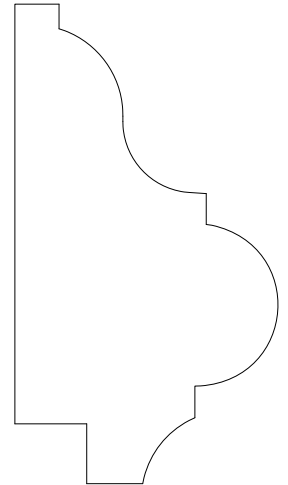

52014

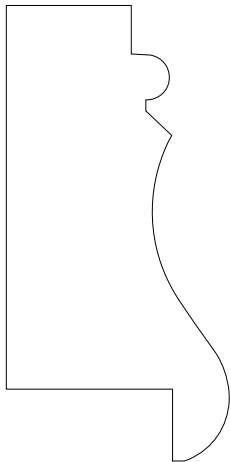

52002

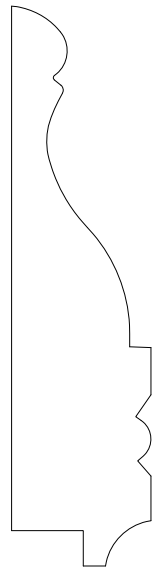

52004

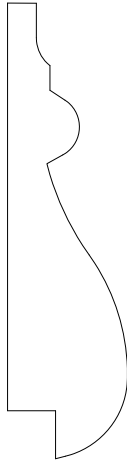

52006

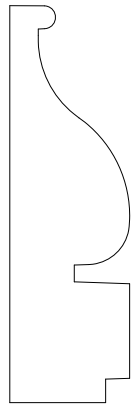

52008

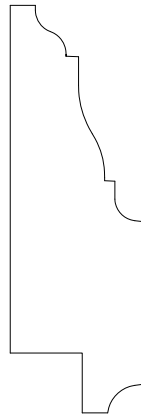

52010

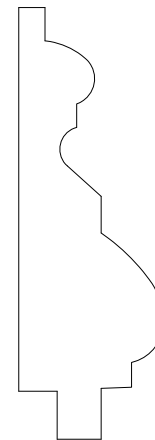

52012

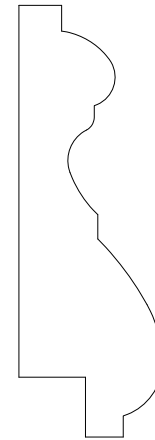

52013

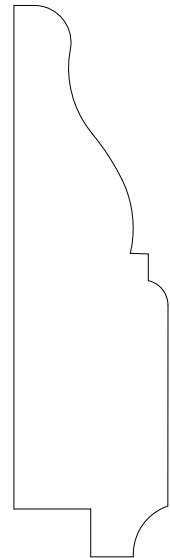

52015

EST. 1879

**S T A R K**

L U M B E R C O M P A N Y

FINE WOOD MOULDING

924 W. 1st. Avenue  
 Denver, CO 80223  
 303-534-8263 Phone  
 303-534-8266 Fax

|              |          |             |
|--------------|----------|-------------|
| Approved by: | MM/DD/YY |             |
| Drawn:       |          |             |
| File name:   |          | Scale 1:1   |
|              |          | Sheet 5-2-1 |

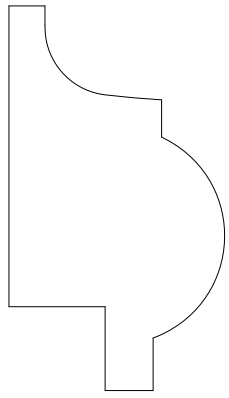

52016

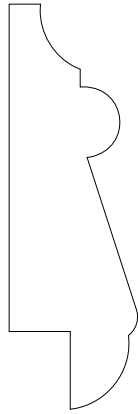

52019

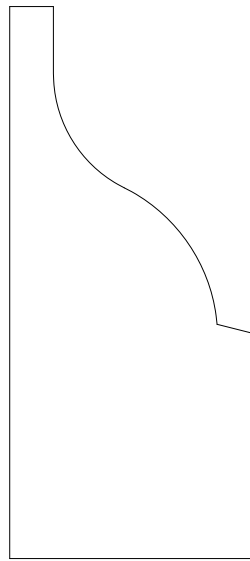

52020

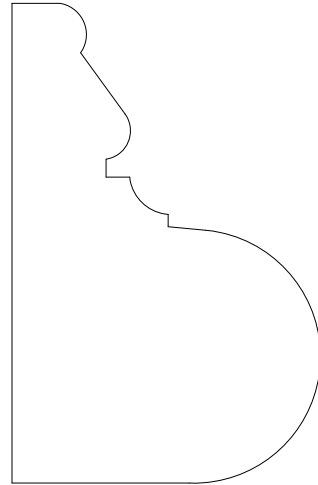

52023

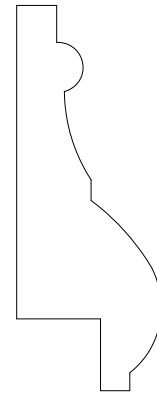

52025

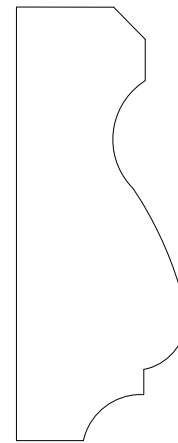

52027

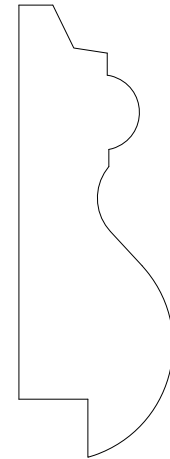

52029

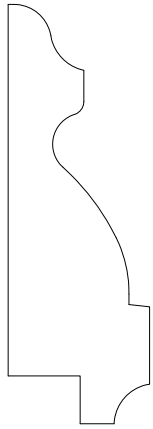

52017

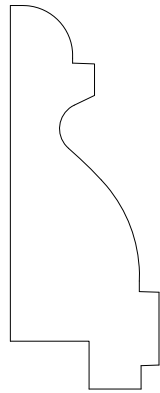

52021

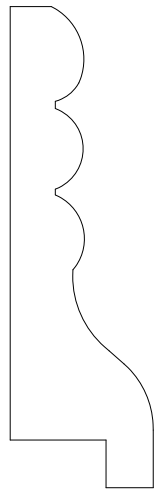

52022

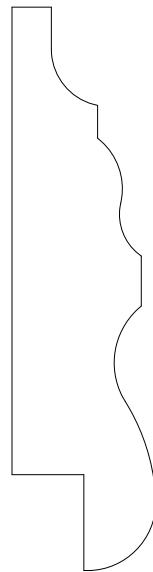

52024

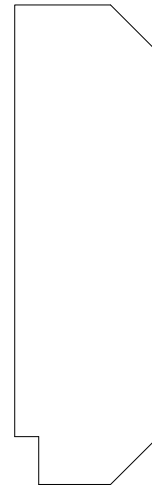

52026

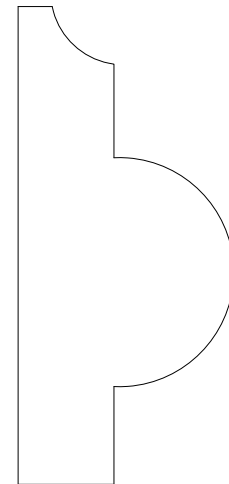

52028

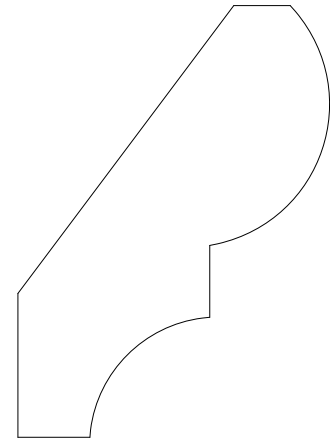

52030

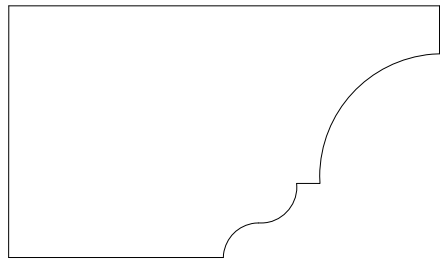

52018

EST. 1879

**S T A R K**

L U M B E R C O M P A N Y

FINE WOOD MOULDING

924 W. 1st. Avenue  
 Denver, CO 80223  
 303-534-8263 Phone  
 303-534-8266 Fax

|              |          |
|--------------|----------|
| Approved by: | MM/DD/YY |
| Drawn:       |          |
| File name:   |          |

Scale 1:1

Sheet 5-2-2

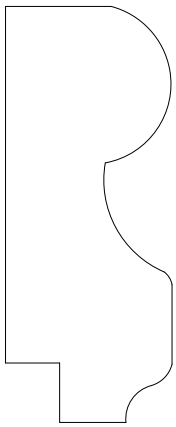

52031

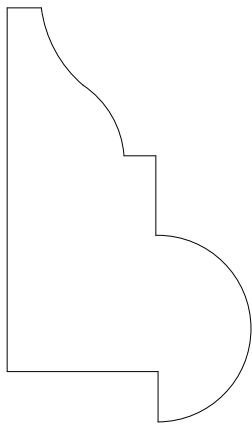

52033

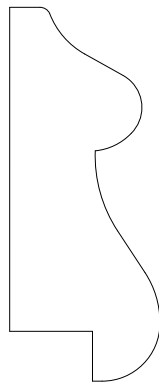

52035

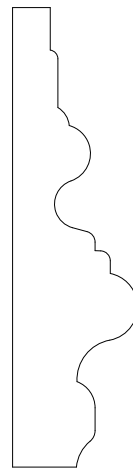

52037

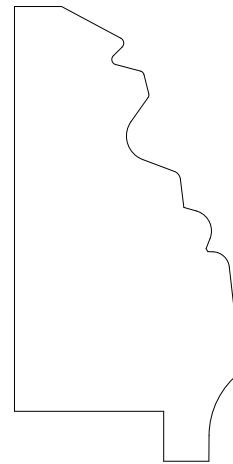

52039

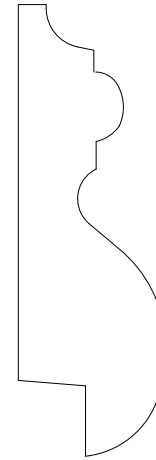

52041

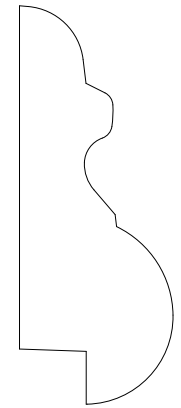

52043

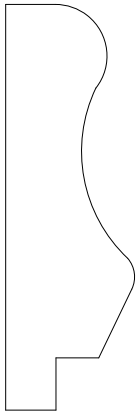

52032

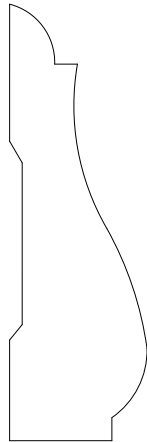

52034

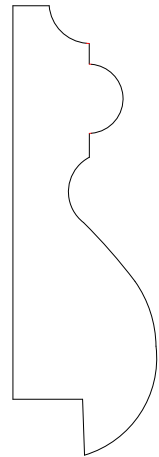

52036

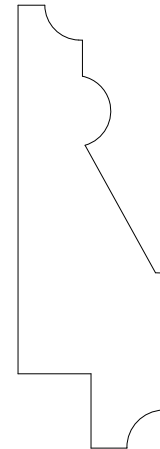

52038

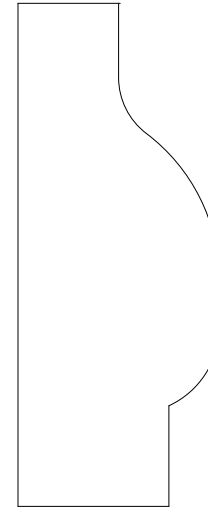

52040



52042

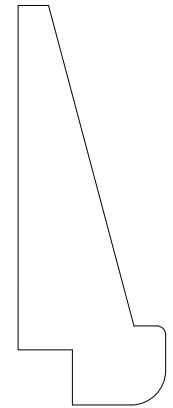

52044

EST. 1879

**S T A R K**

L U M B E R C O M P A N Y

FINE WOOD MOULDING

924 W. 1st. Avenue  
 Denver, CO 80223  
 303-534-8263  
 Phone  
 303-534-8266 Fax

|              |          |           |             |
|--------------|----------|-----------|-------------|
| Approved by: | MM/DD/YY |           |             |
| Drawn:       |          |           |             |
| File name:   |          | Scale 1:1 | Sheet 5-2-3 |



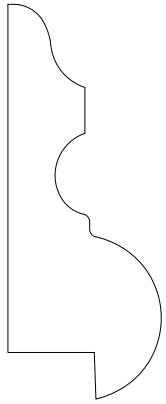

52045

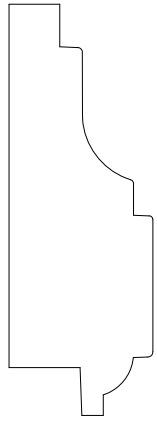

52047

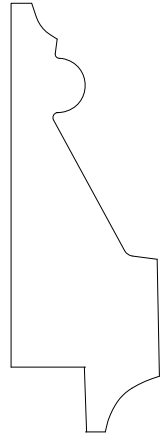

52049

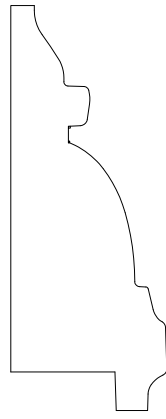

52051

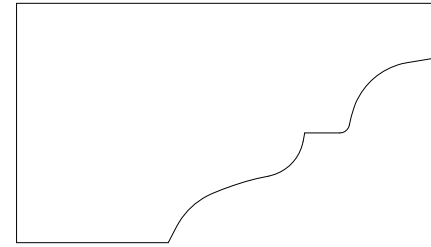

52055

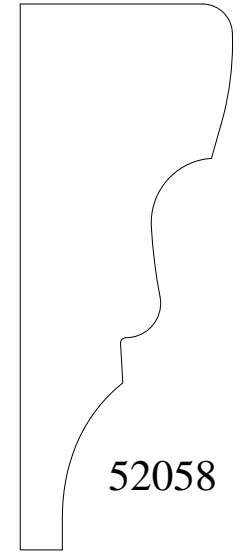

52058

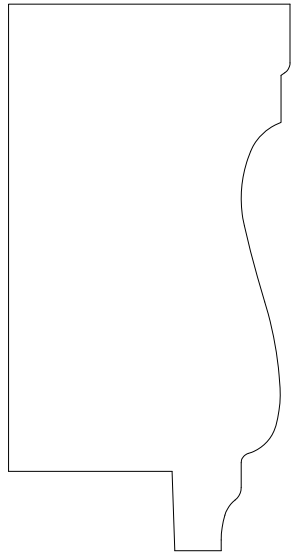

52046

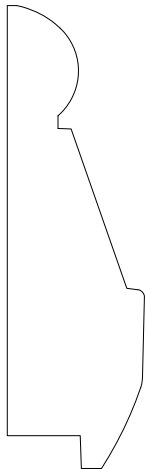

52048

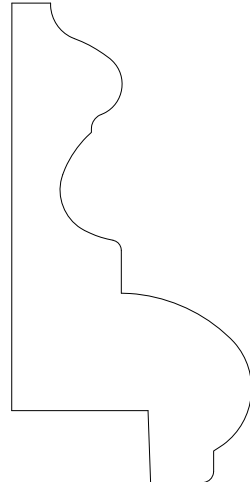

52050

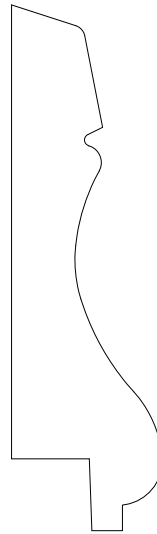

52052



52056

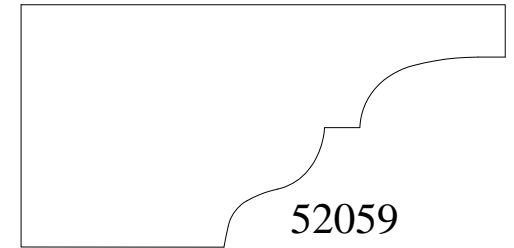

52059

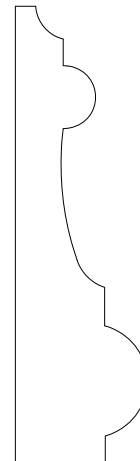

52054

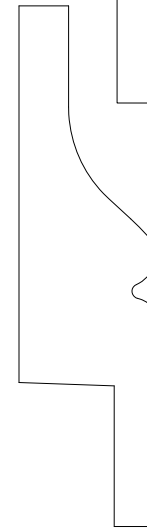

52057

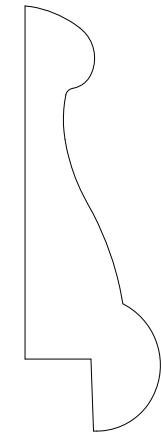

52060

EST. 1879

**S T A R K**

L U M B E R C O M P A N Y

FINE WOOD MOULDING

924 W. 1st. Avenue  
 Denver, CO 80223  
 303-534-8263 Phone  
 303-534-8266 Fax

|              |          |                       |
|--------------|----------|-----------------------|
| Approved by: | MM/DD/YY |                       |
| Drawn:       |          |                       |
| File name:   |          | Scale 1:1 Sheet 5-2-4 |

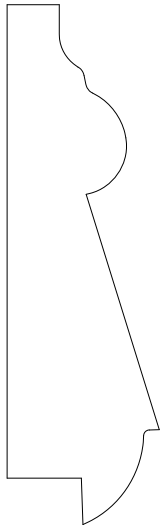

52061

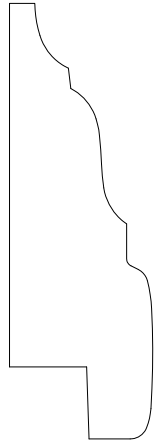

52063

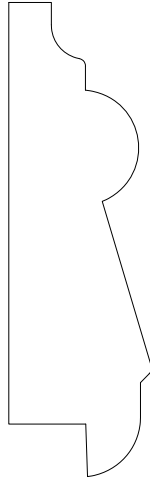

52065

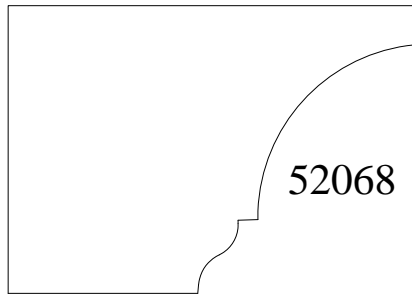

52068



52069

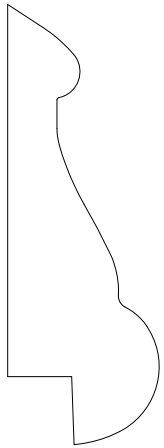

52062

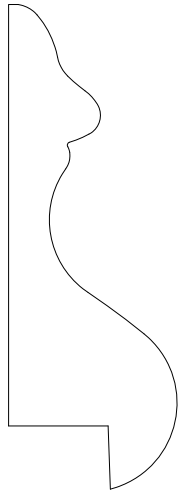

52064

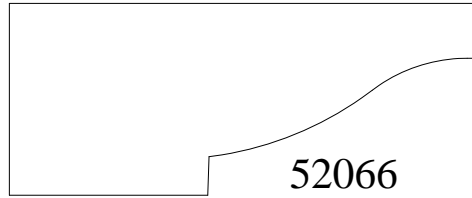

52066

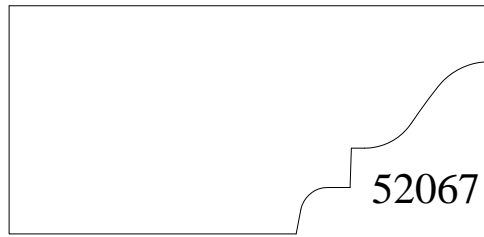

52067

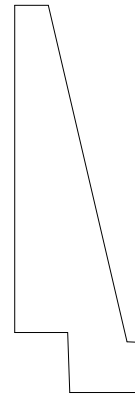

52070

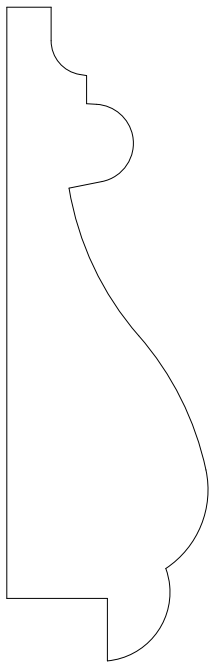

53001

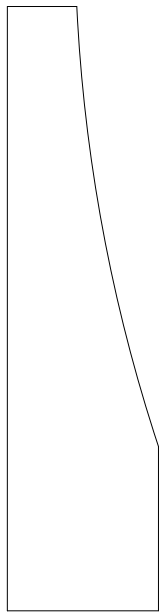

53003

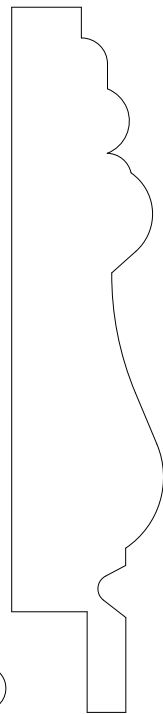

53005

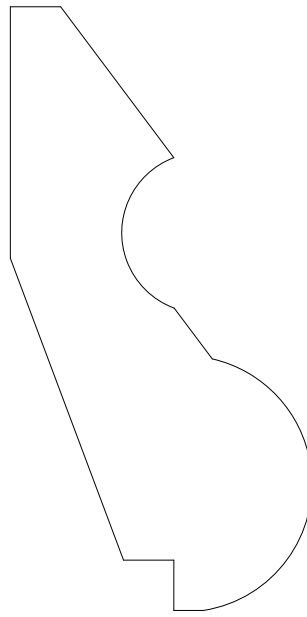

53006

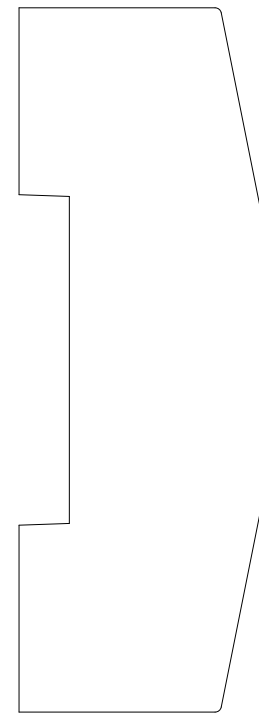

53008



53010

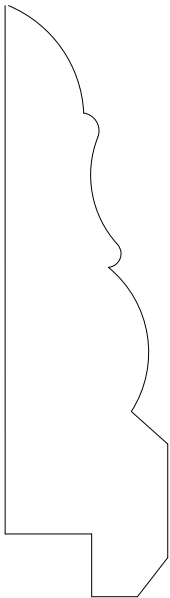

53002

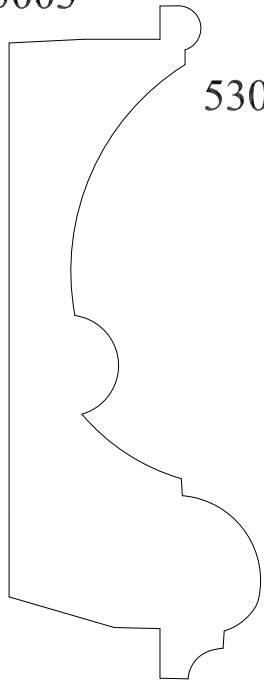

53004



53007

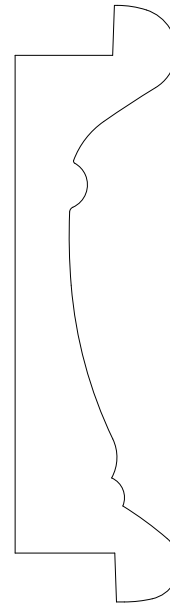

53009

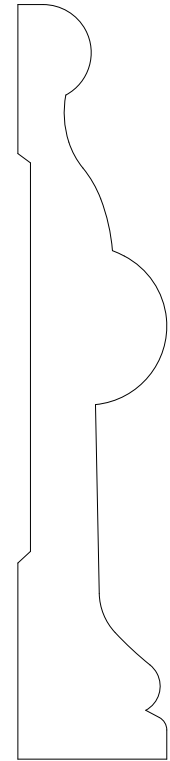

53011

EST. 1879

**S T A R K**

L U M B E R C O M P A N Y

FINE WOOD MOULDING

924 W. 1st. Avenue  
 Denver, CO 80223  
 303-534-8263  
 Phone  
 303-534-8266 Fax

|  |
|--|
|  |
|--|

|              |          |
|--------------|----------|
| Approved by: | MM/DD/YY |
| Drawn:       |          |
| File name:   |          |

|           |             |
|-----------|-------------|
| Scale 1:1 | Sheet 5-3-1 |
|-----------|-------------|

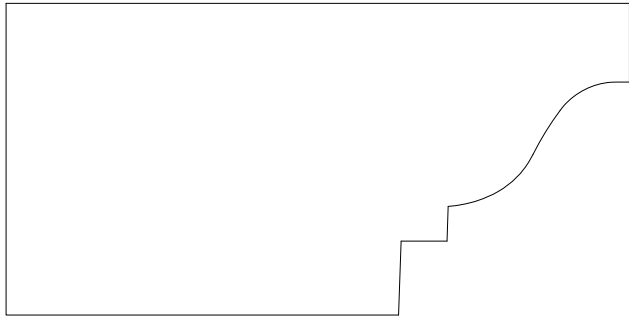

53012

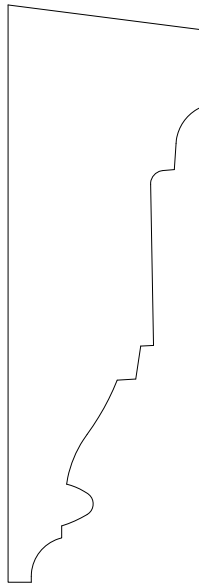

53015

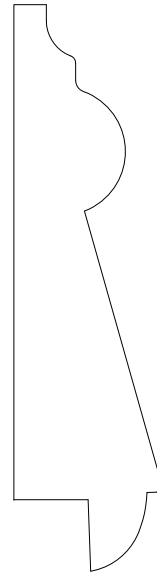

53017

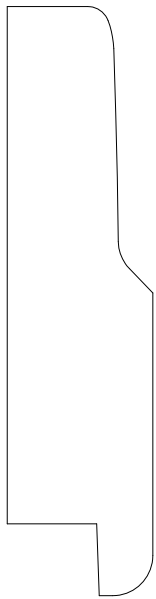

53013

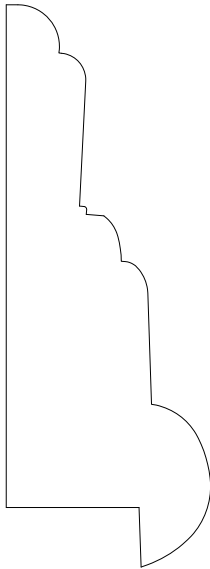

53014

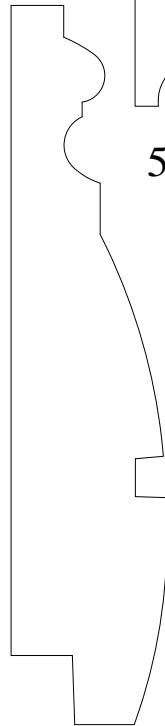

53016

EST. 1879

**S T A R K**

L U M B E R C O M P A N Y

FINE WOOD MOULDING

924 W. 1st. Avenue  
 Denver, CO 80223  
 303-534-8263 Phone  
 303-534-8266 Fax

|              |          |                       |
|--------------|----------|-----------------------|
| Approved by: | MM/DD/YY |                       |
| Drawn:       |          |                       |
| File name:   |          | Scale 1:1 Sheet 5-3-2 |

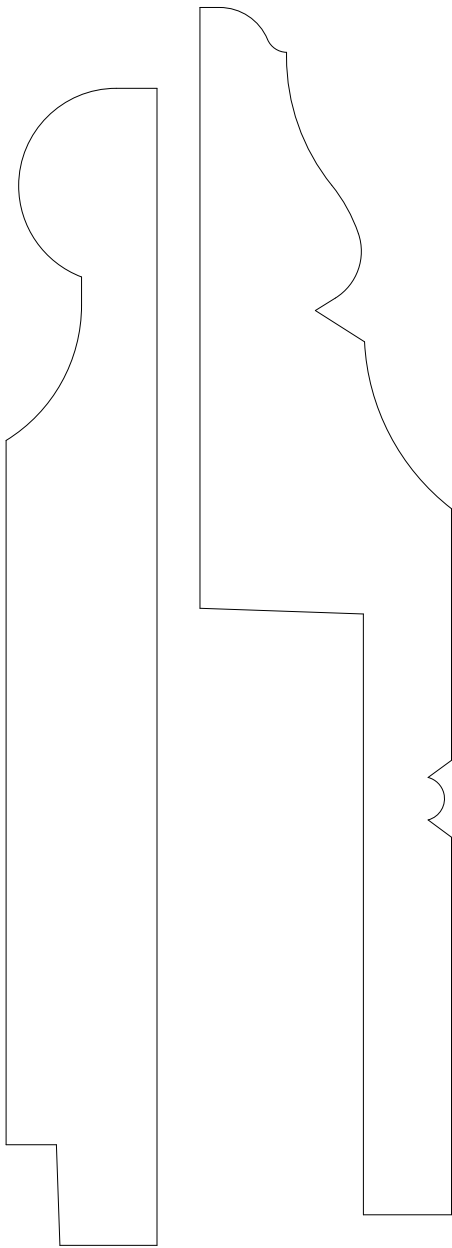

55001

56001

EST. 1879

**S T A R K**

L U M B E R C O M P A N Y

FINE WOOD MOULDING

924 W. 1st. Avenue  
 Denver, CO 80223  
 303-534-8263  
 Phone

303-534-8266 Fax

|              |          |                       |
|--------------|----------|-----------------------|
| Approved by: | MM/DD/YY |                       |
| Drawn:       |          |                       |
| File name:   |          | Scale 1:1 Sheet 5-5-1 |

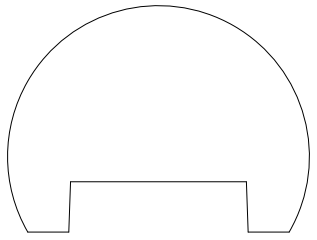

61001

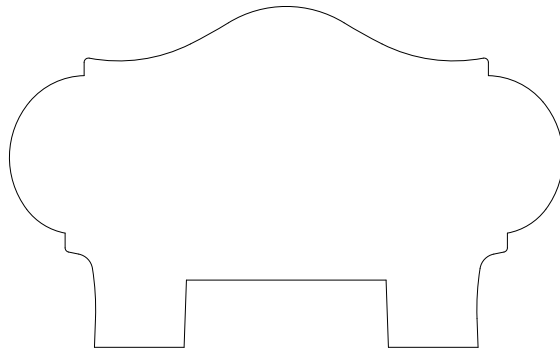

61004

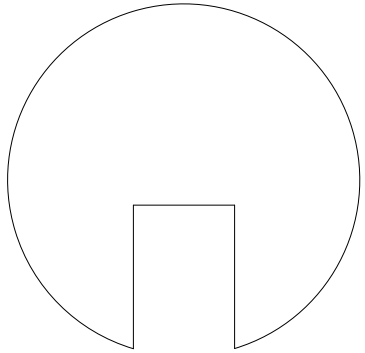

61002

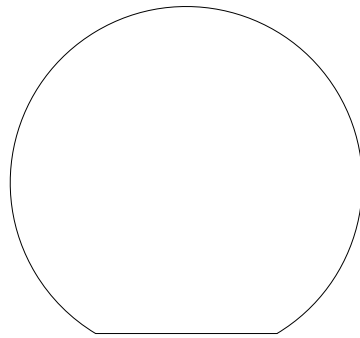

61005

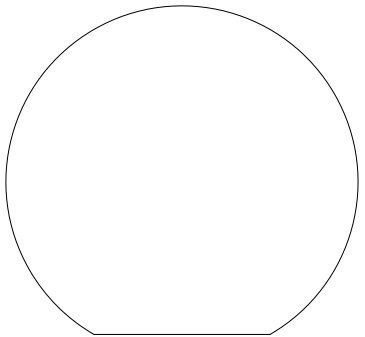

61003

|  |  |
|--|--|
|  | EST. 1879<br>924 W. 1st. Avenue<br>Denver, CO 80223<br>303-534-8263<br>Phone |
|  | 303-534-8266 Fax   |

|  |
|--|
|  |
|--|

|              |          |
|--------------|----------|
| Approved by: | MM/DD/YY |
| Drawn:       |          |
| File name:   |          |

|           |             |
|-----------|-------------|
| Scale 1:1 | Sheet 6-1-1 |
|-----------|-------------|

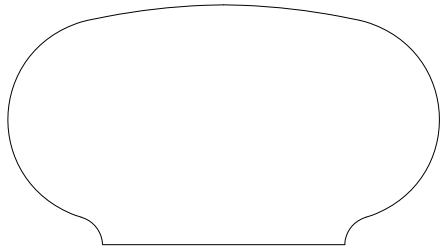

62001

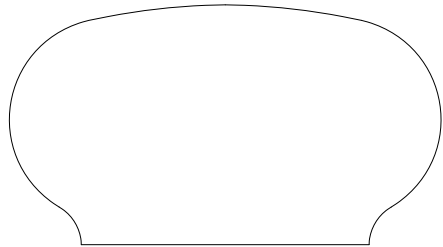
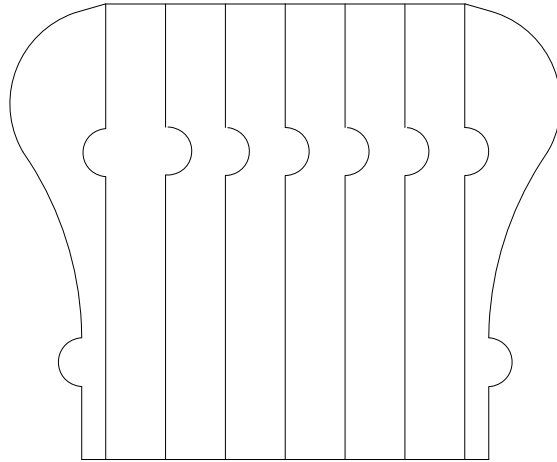

62002

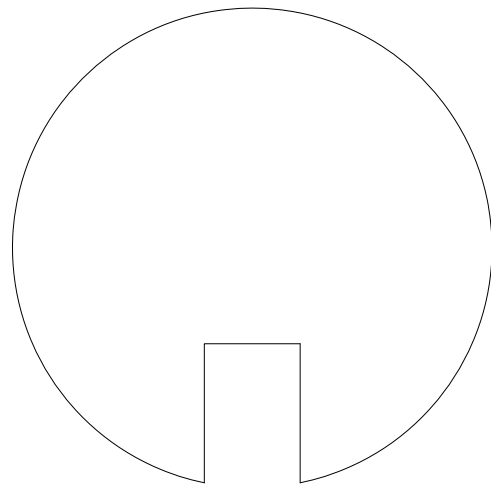

62003

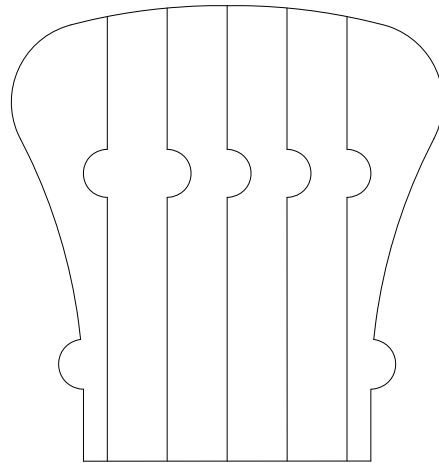

62004

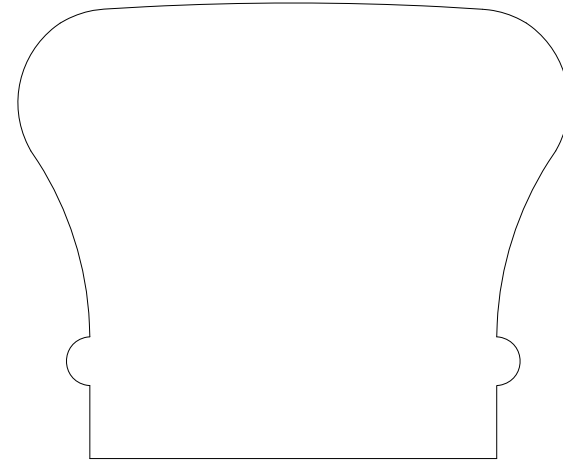

62006

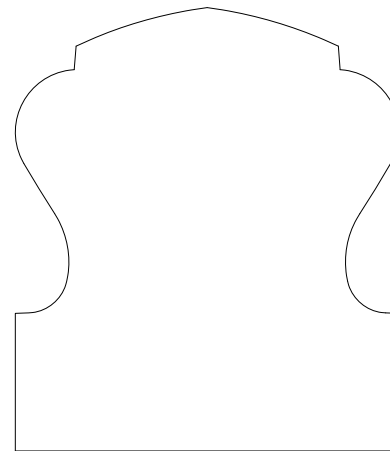

62005

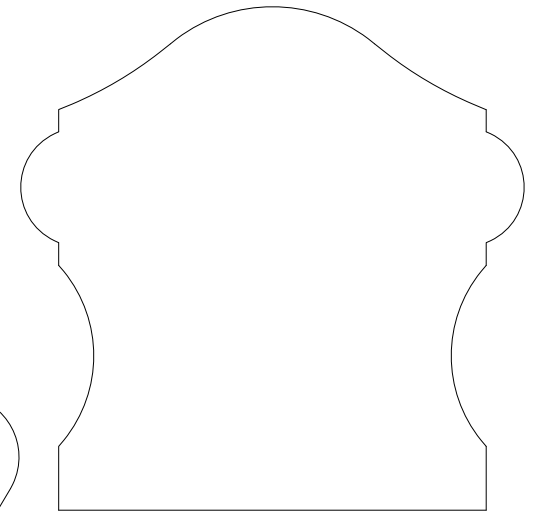

62007

EST. 1879

**S T A R K**

L U M B E R C O M P A N Y

FINE WOOD MOULDING

924 W. 1st. Avenue  
 Denver, CO 80223  
 303-534-8263 Phone  
 303-534-8266 Fax

|              |          |             |
|--------------|----------|-------------|
| Approved by: | MM/DD/YY |             |
| Drawn:       |          |             |
| File name:   |          | Scale 1:1   |
|              |          | Sheet 6-2-1 |

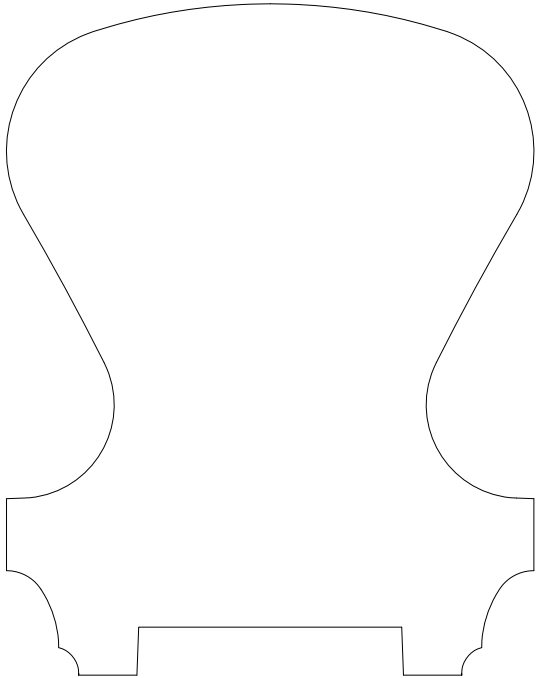

62008

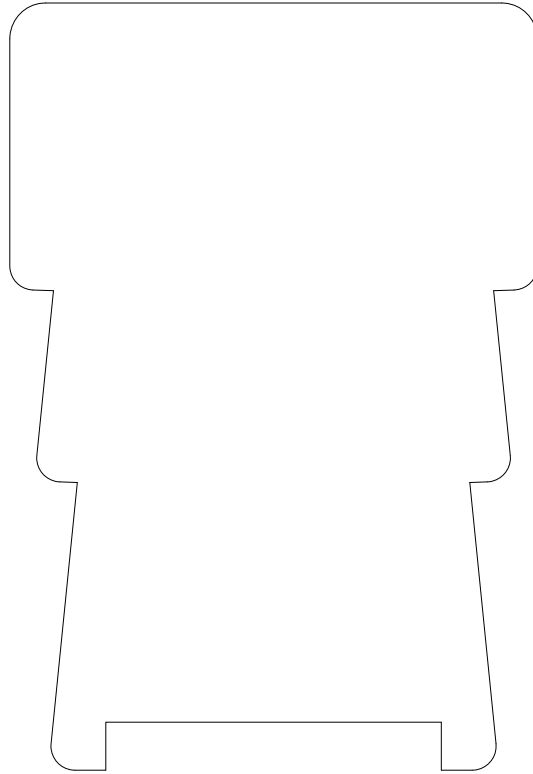

62009

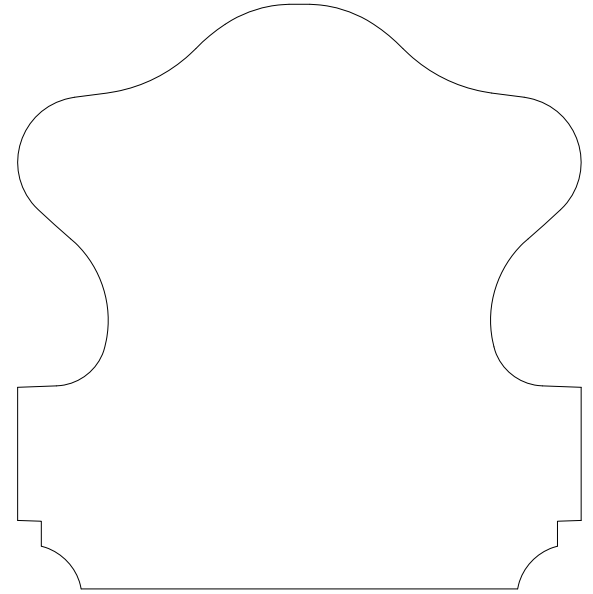

62010

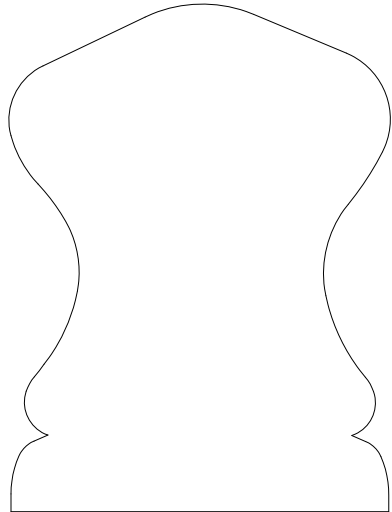

62013

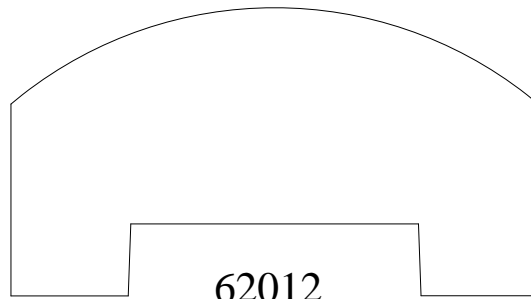

62012

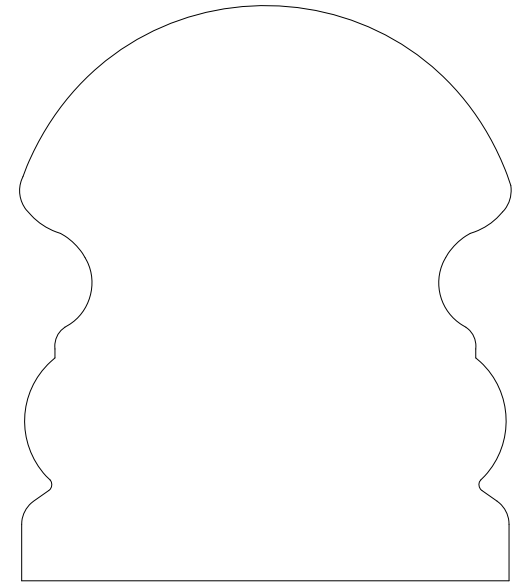

62011

EST. 1879

**S T A R K**

LUMBER COMPANY

FINE WOOD MOULDING

924 W. 1st. Avenue  
 Denver, CO 80223  
 303-534-8263 Phone  
 303-534-8266 Fax

|              |          |             |
|--------------|----------|-------------|
| Approved by: | MM/DD/YY |             |
| Drawn:       |          |             |
| File name:   |          | Scale 1:1   |
|              |          | Sheet 6-2-2 |



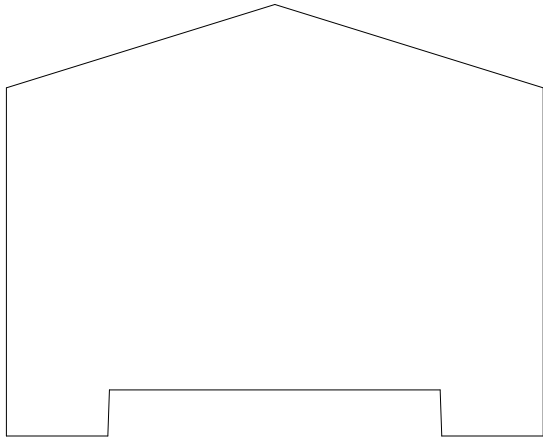

62014

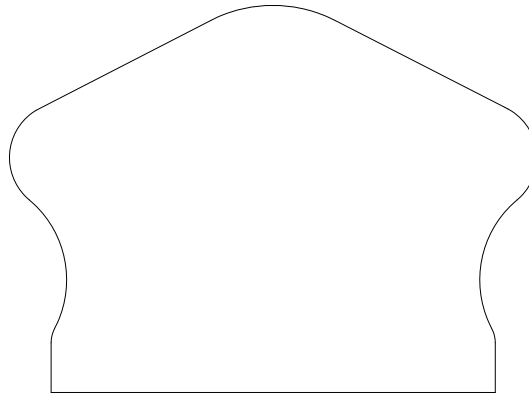

62016

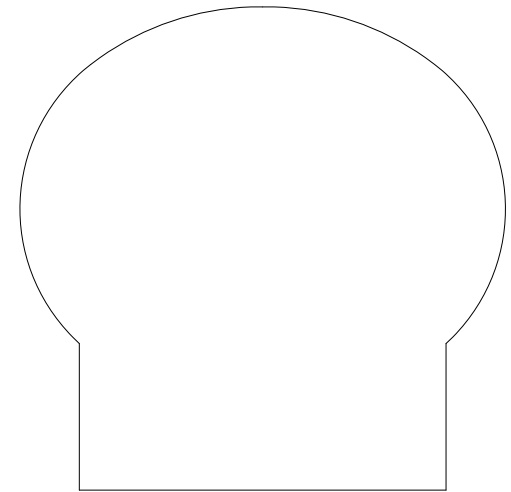

62018

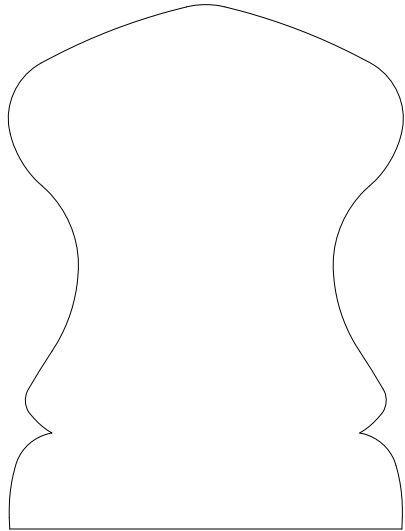

62015

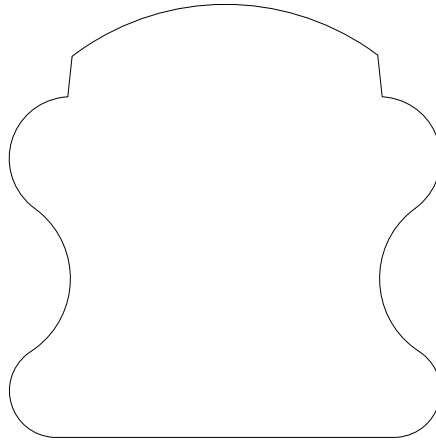

62017

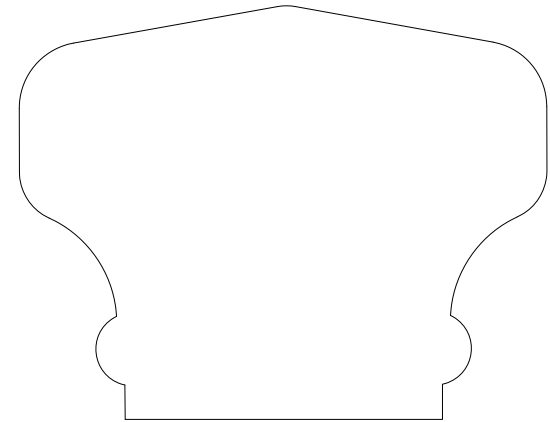

62019

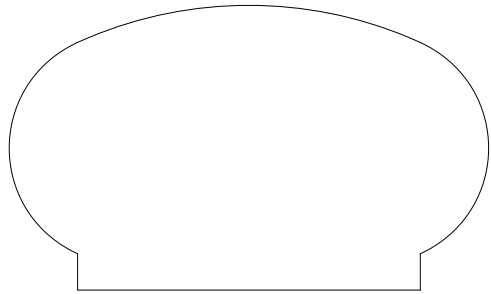

62020

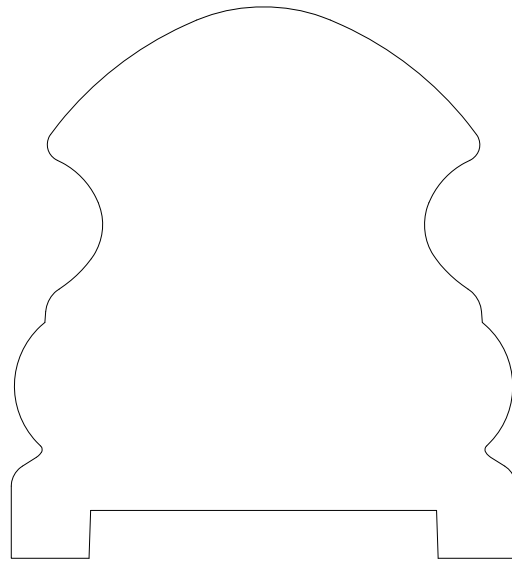

62021

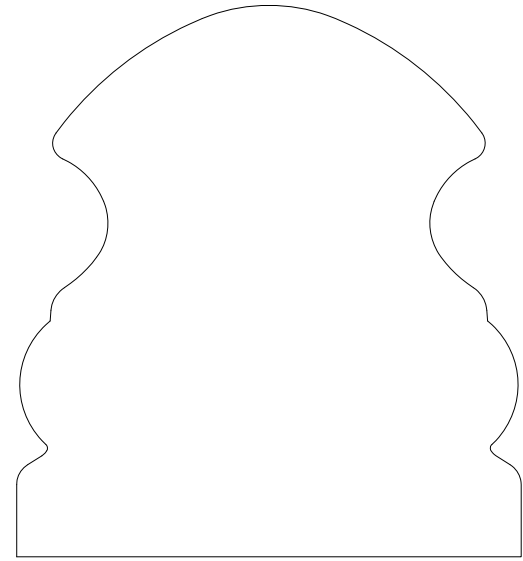

62022

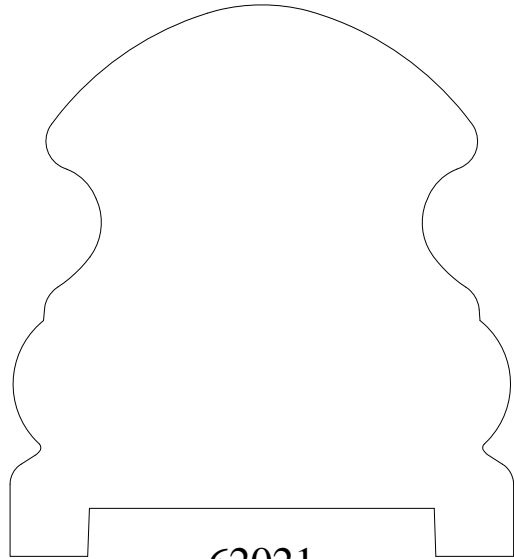

62023

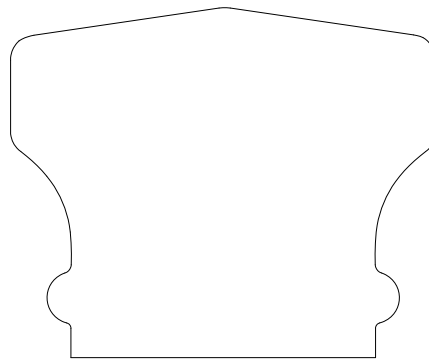

62024

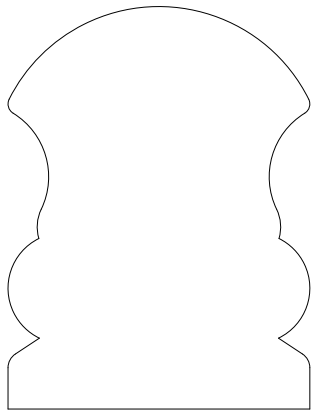

62025

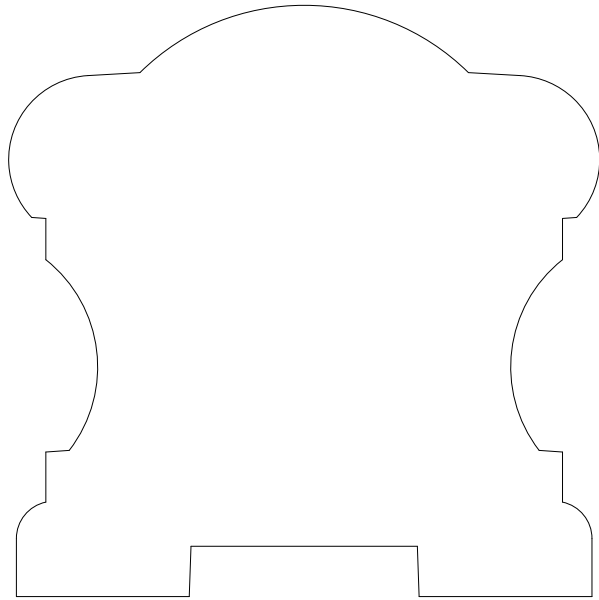

62026

EST. 1879  
**S T A R K**  
L U M B E R C O M P A N Y  
FINE WOOD MOULDING

924 W. 1st. Avenue  
Denver, CO 80223  
303-534-8263  
Phone  
303-534-8266 Fax

|  |
|--|
|  |
|--|

|              |          |
|--------------|----------|
| Approved by: | MM/DD/YY |
| Drawn:       |          |
| File name:   |          |

|           |             |
|-----------|-------------|
| Scale 1:1 | Sheet 6-2-5 |
|-----------|-------------|

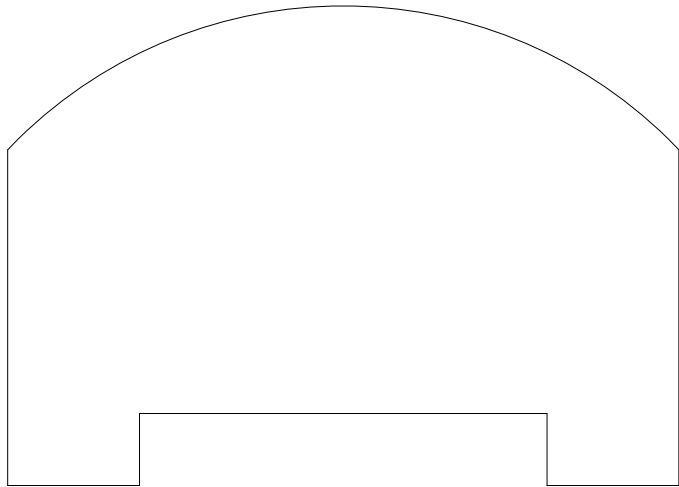

63001

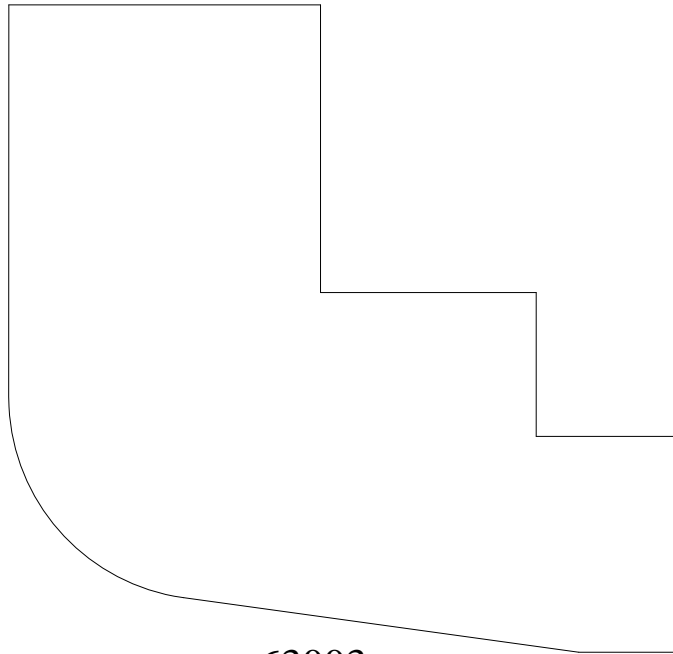

63003

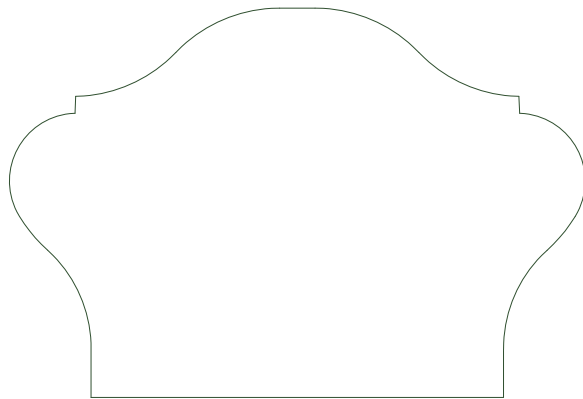

63002

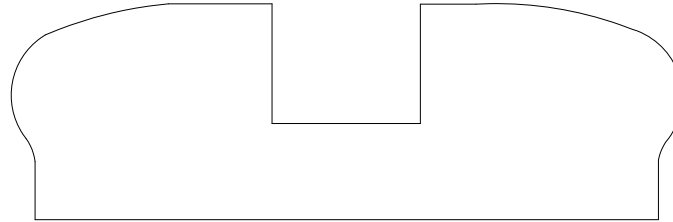

63004

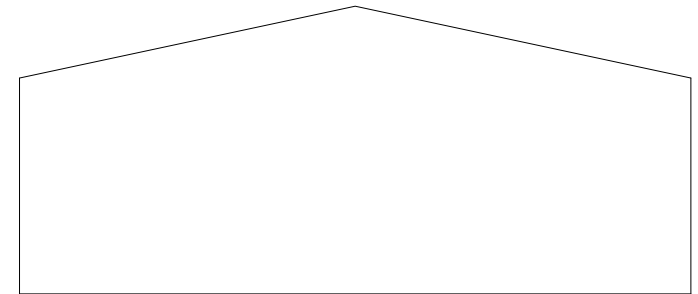

63005

EST. 1879

**S T A R K**

L U M B E R C O M P A N Y

FINE WOOD MOULDING

924 W. 1st. Avenue  
 Denver, CO 80223  
 303-534-8263 Phone  
 303-534-8266 Fax

|              |          |             |
|--------------|----------|-------------|
| Approved by: | MM/DD/YY |             |
| Drawn:       |          |             |
| File name:   |          | Scale 1:1   |
|              |          | Sheet 6-3-1 |

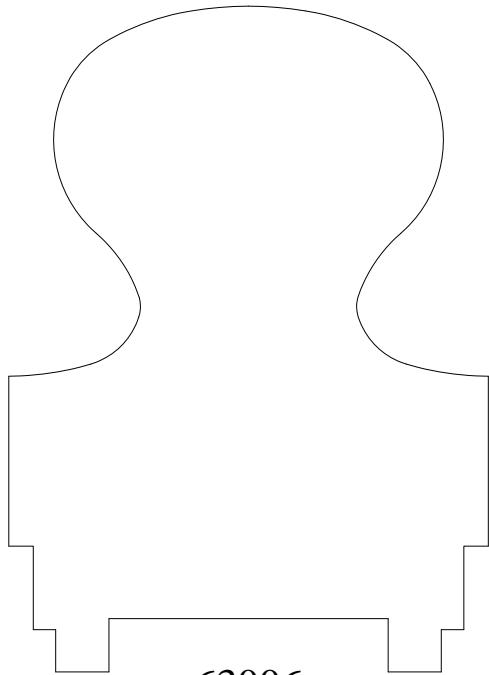

63006

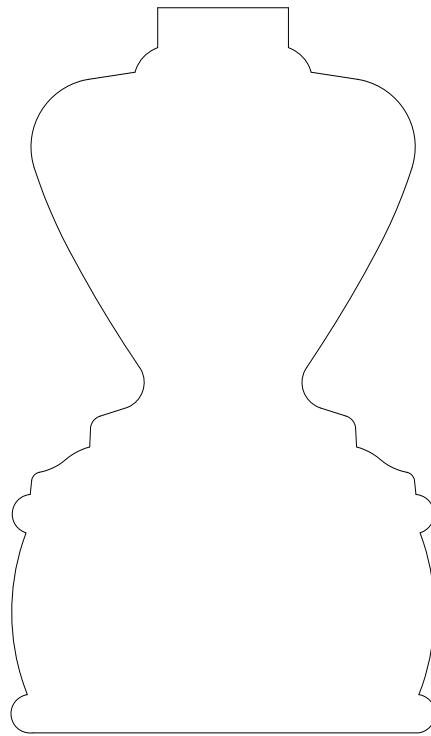

63008

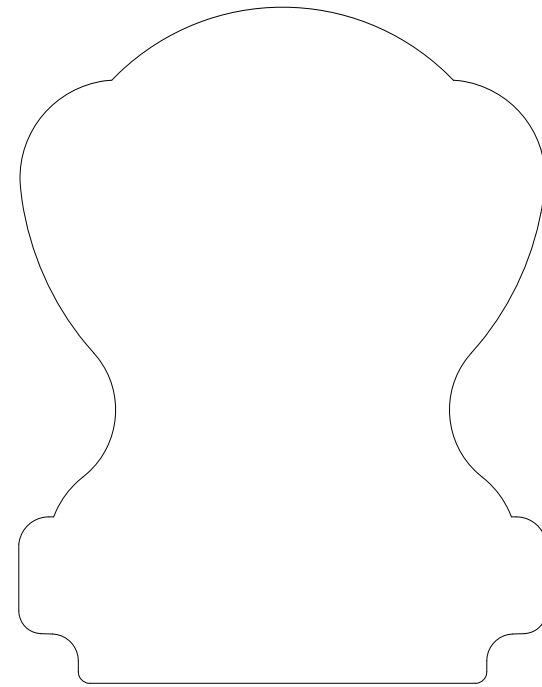

63009

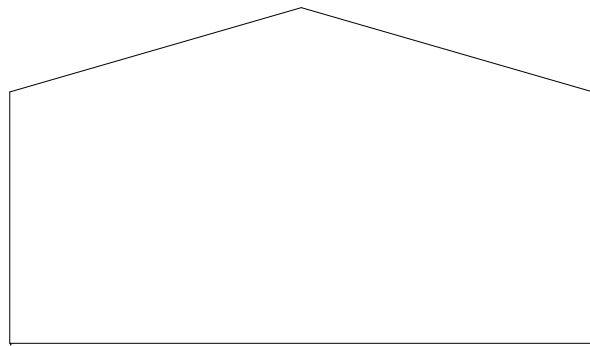

63007

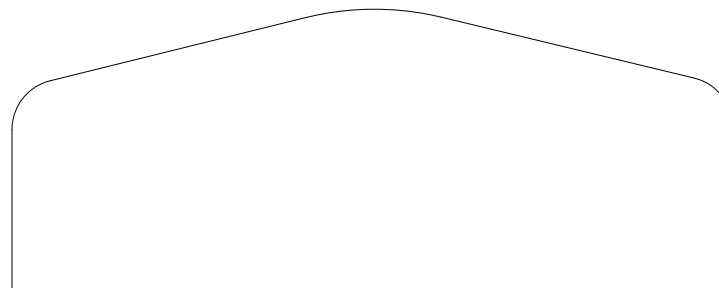

63010

EST. 1879

**S T A R K**

L U M B E R C O M P A N Y

FINE WOOD MOULDING

924 W. 1st. Avenue  
 Denver, CO 80223  
 303-534-8263 Phone  
 303-534-8266 Fax

|              |          |                       |
|--------------|----------|-----------------------|
| Approved by: | MM/DD/YY |                       |
| Drawn:       |          |                       |
| File name:   |          | Scale 1:1 Sheet 6-3-2 |

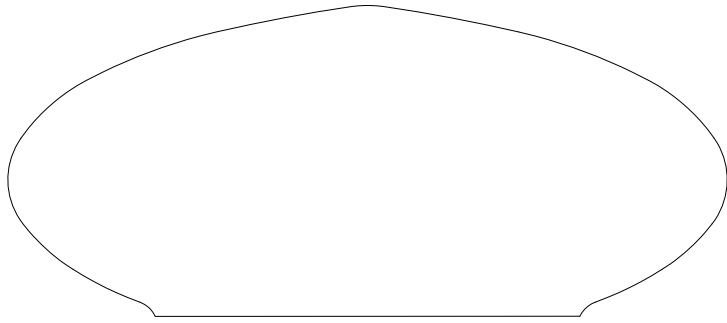

63011

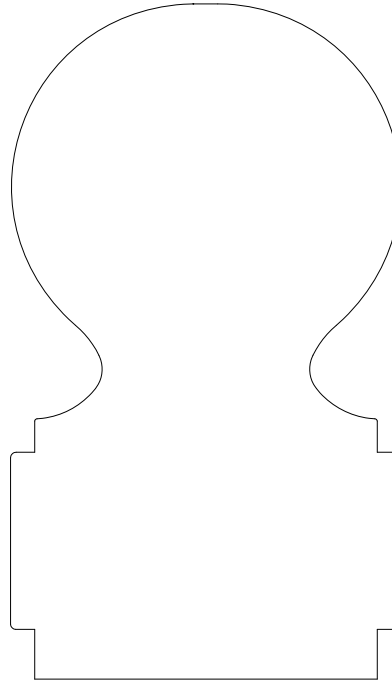

63013

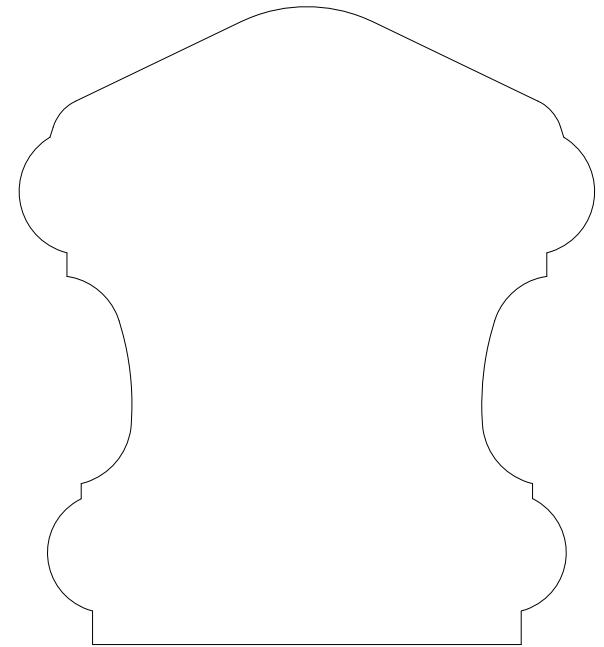

63015

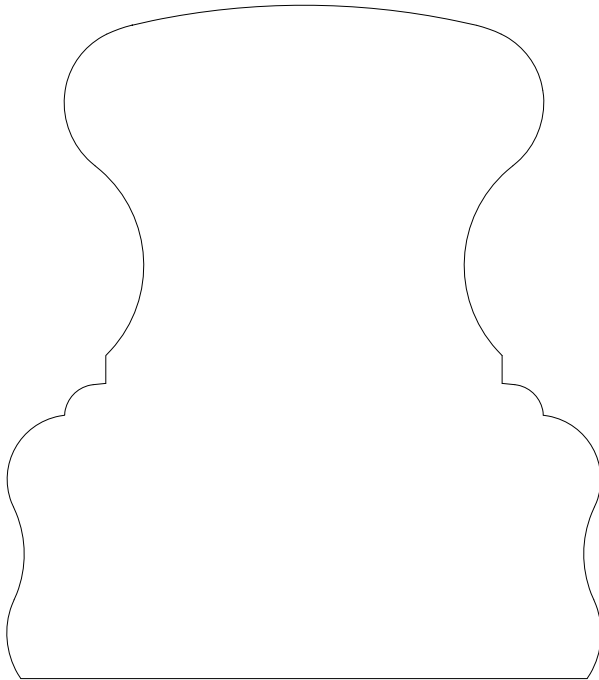

63012

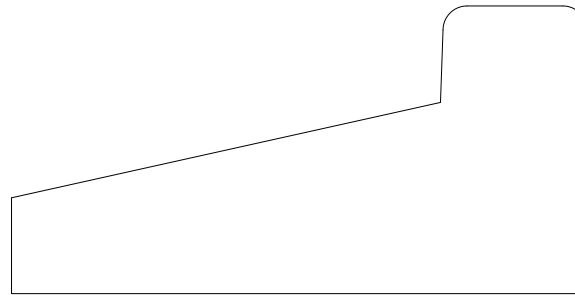

63014

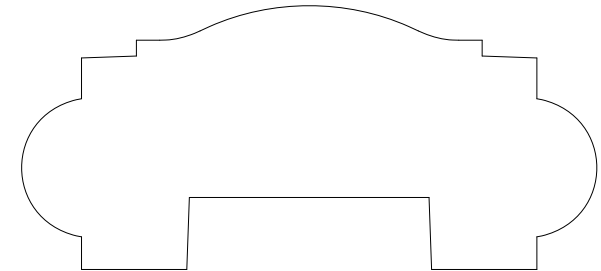

63016

EST. 1879

**S T A R K**

L U M B E R C O M P A N Y

FINE WOOD MOULDING

924 W. 1st. Avenue  
 Denver, CO 80223  
 303-534-8263 Phone  
 303-534-8266 Fax

|              |          |                       |
|--------------|----------|-----------------------|
| Approved by: | MM/DD/YY |                       |
| Drawn:       |          |                       |
| File name:   |          | Scale 1:1 Sheet 6-3-3 |

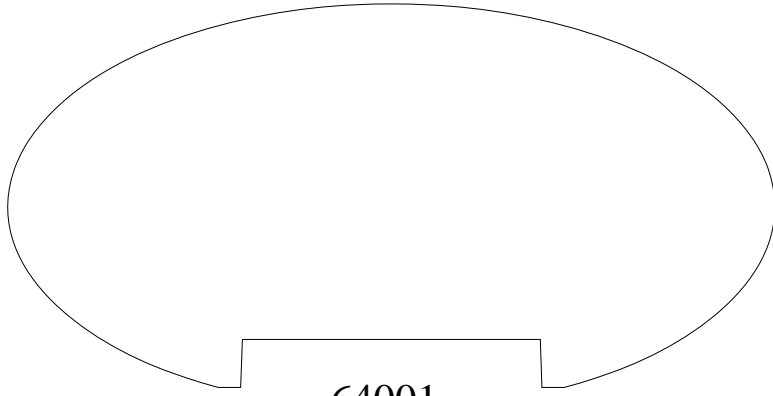

64001

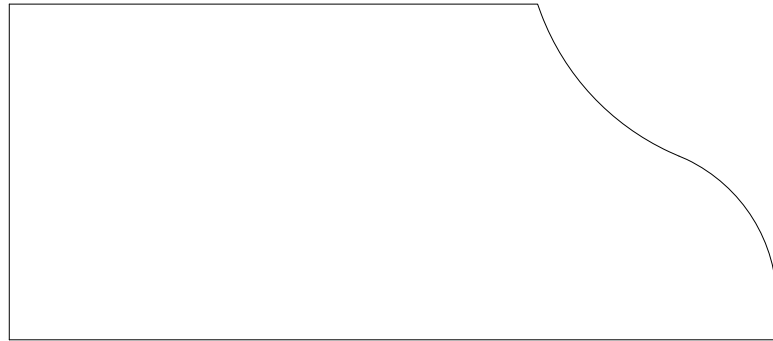

64002

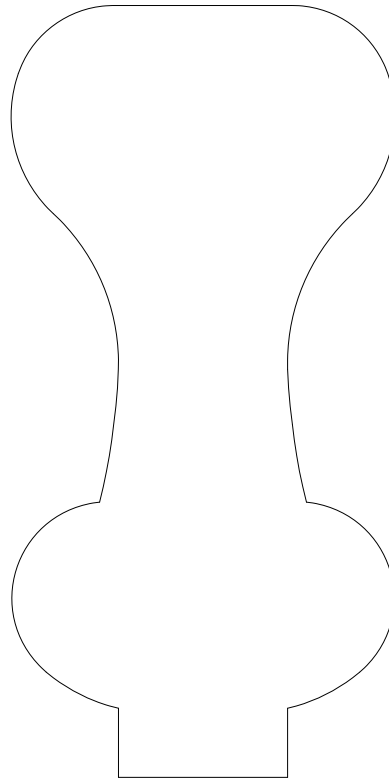

64003

|   |  |              |          |           |             |
|---|--|--------------|----------|-----------|-------------|
|  <p><b>S T A R K</b><br/>L U M B E R C O M P A N Y<br/>FINE WOOD MOULDING</p> | <p>924 W. 1st. Avenue<br/>Denver, CO 80223<br/>303-534-8263 Phone<br/>303-534-8266 Fax</p> | Approved by: | MM/DD/YY | Scale 1:1 | Sheet 6-4-1 |
|   |  | Drawn:       |          |           |             |
|   |  | File name:   |          |           |             |

|              |          |           |             |
|--------------|----------|-----------|-------------|
| Approved by: | MM/DD/YY | Scale 1:1 | Sheet 6-4-1 |
| Drawn:       |          |           |             |
| File name:   |          |           |             |

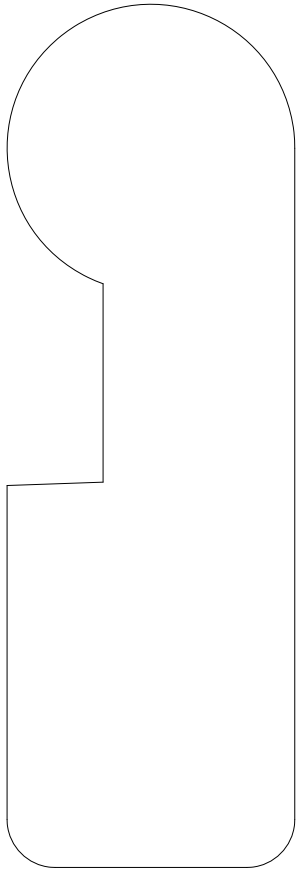

64005

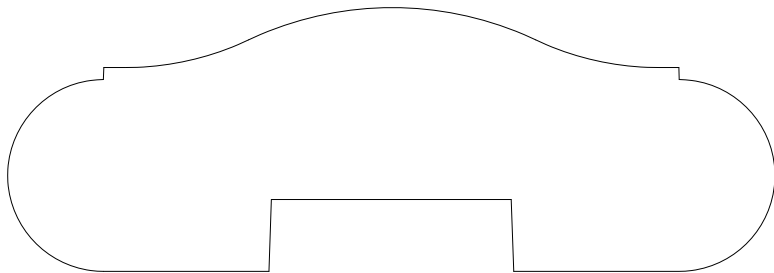

64006

|                           |   |
|---------------------------|---|
| EST. 1879                 |   |
| S                         | T |
| A                         | R |
| K                         |   |
| L U M B E R C O M P A N Y |   |
| FINE WOOD MOULDING        |   |

924 W. 1st. Avenue  
 Denver, CO 80223  
 303-534-8263 Phone  
 303-534-8266 Fax

|              |          |                       |
|--------------|----------|-----------------------|
| Approved by: | MM/DD/YY |                       |
| Drawn:       |          |                       |
| File name:   |          | Scale 1:1 Sheet 6-4-2 |



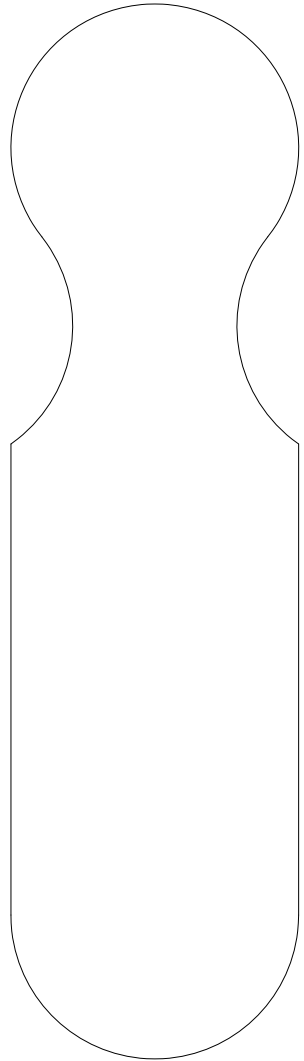

65001

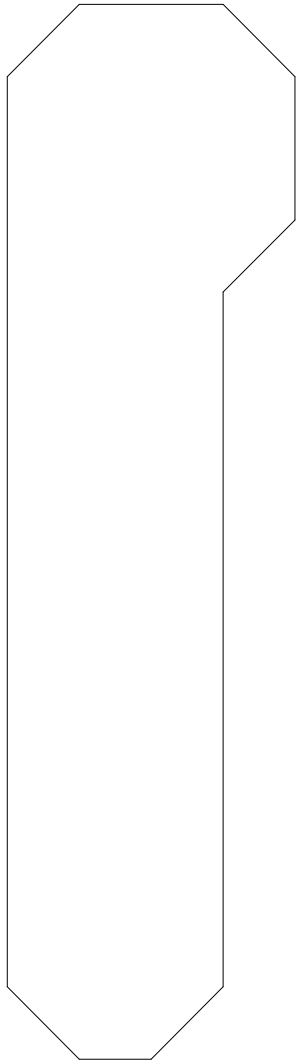

65002

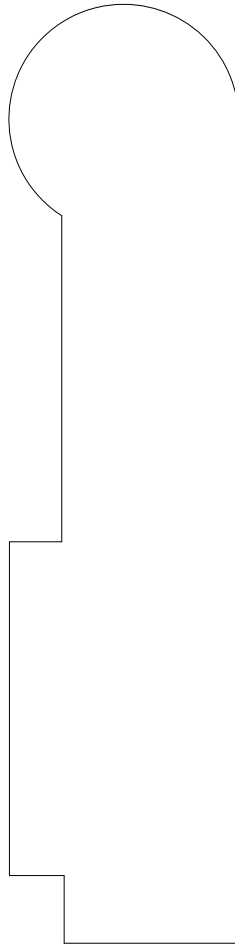

65003

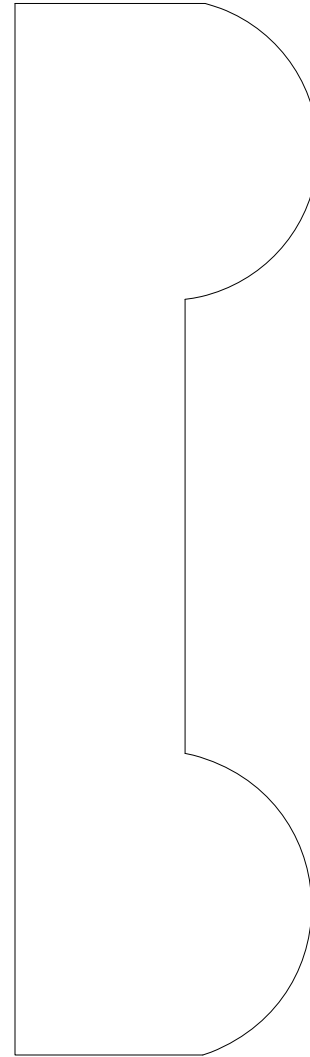

65006

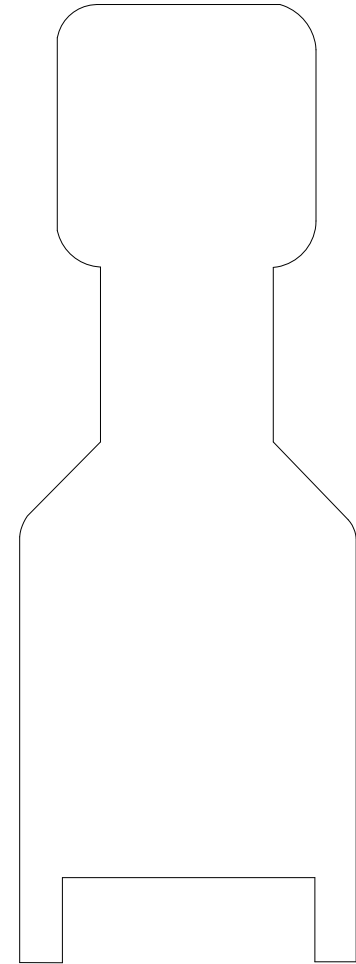

65007

EST. 1879

**S T A R K**

L U M B E R C O M P A N Y

FINE WOOD MOULDING

924 W. 1st. Avenue  
 Denver, CO 80223  
 303-534-8263 Phone  
 303-534-8266 Fax

|              |          |             |
|--------------|----------|-------------|
| Approved by: | MM/DD/YY |             |
| Drawn:       |          |             |
| File name:   |          | Scale 1:1   |
|              |          | Sheet 6-5-1 |

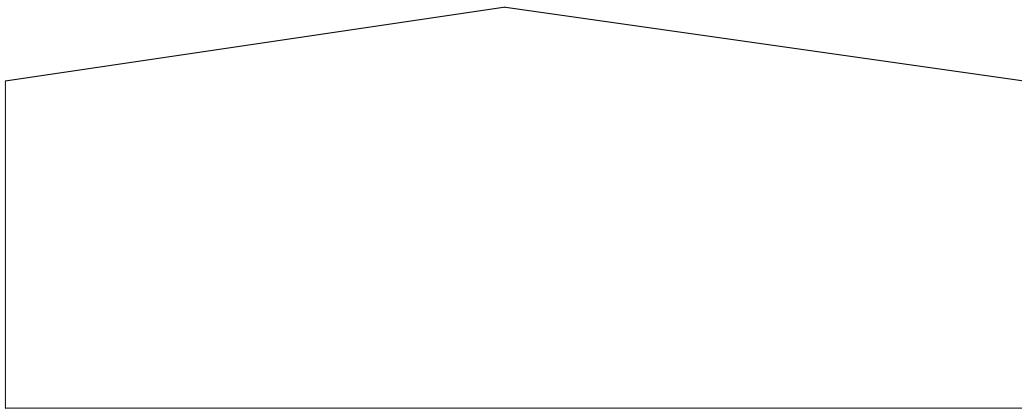

65004

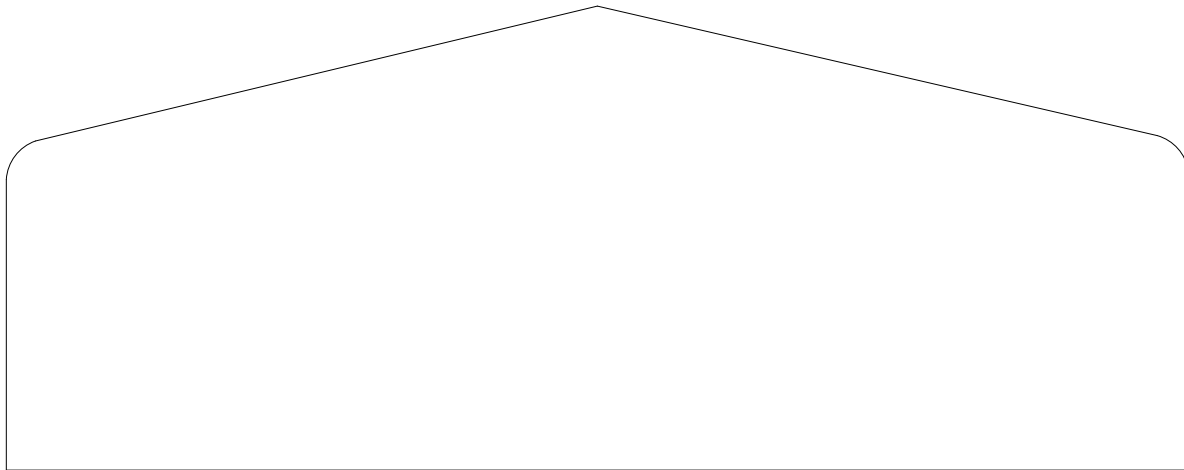

65005

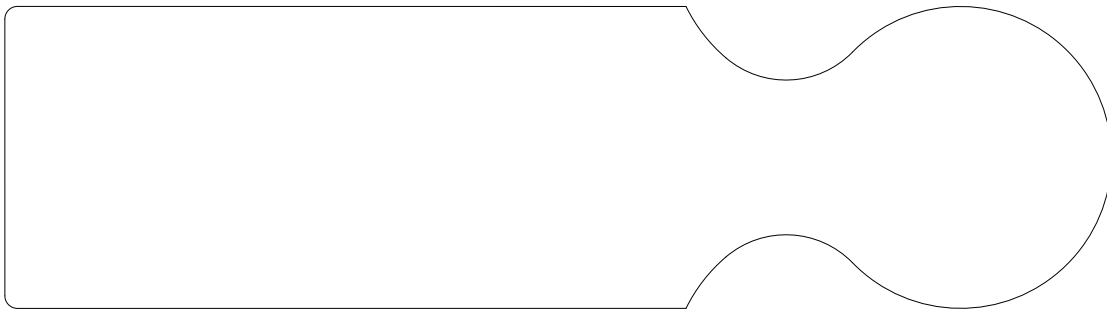

65010

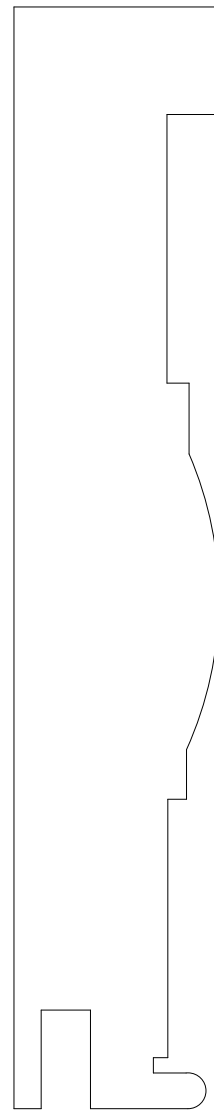

65008

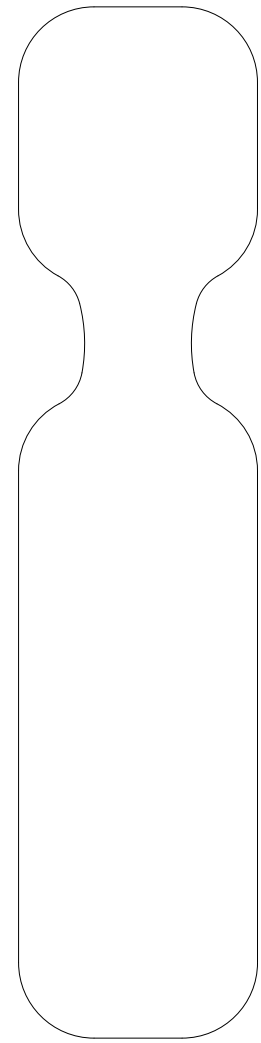

65009

|                           |   |
|---------------------------|---|
| EST. 1879                 | 924 W. 1st. Avenue<br>Denver, CO 80223<br>303-534-8263<br>Phone<br>303-534-8266 Fax |
| S T A R K                 |   |
| L U M B E R C O M P A N Y |   |
| FINE WOOD MOULDING        |   |

|  |
|--|
|  |
|--|

|              |          |
|--------------|----------|
| Approved by: | MM/DD/YY |
| Drawn:       |          |
| File name:   |          |

|           |             |
|-----------|-------------|
| Scale 1:1 | Sheet 6-5-2 |
|-----------|-------------|

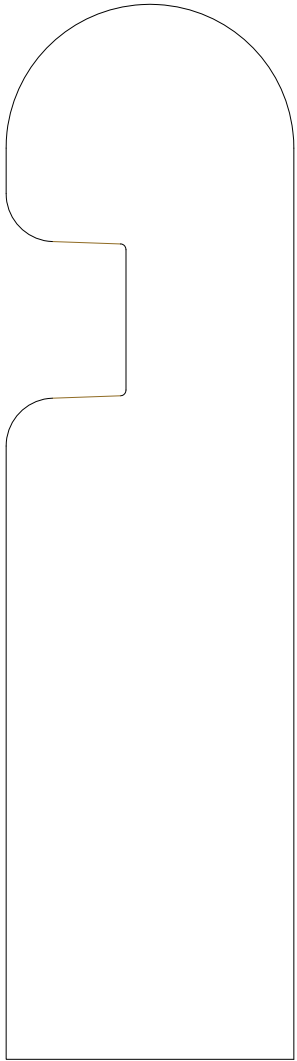

65011

EST. 1879  
**S T A R K**  
L U M B E R C O M P A N Y  
FINE WOOD MOULDING

924 W. 1st. Avenue  
Denver, CO 80223  
303-534-8263 Phone  
303-534-8266 Fax

|              |          |           |             |
|--------------|----------|-----------|-------------|
| Approved by: | MM/DD/YY |           |             |
| Drawn:       |          |           |             |
| File name:   |          | Scale 1:1 | Sheet 6-5-3 |



66001

EST. 1879  
**S T A R K**  
L U M B E R C O M P A N Y  
FINE WOOD MOULDING

924 W. 1st. Avenue  
Denver, CO 80223  
303-534-8263 Phone  
303-534-8266 Fax

|              |          |           |             |
|--------------|----------|-----------|-------------|
| Approved by: | MM/DD/YY |           |             |
| Drawn:       |          |           |             |
| File name:   |          | Scale 1:1 | Sheet 6-6-1 |

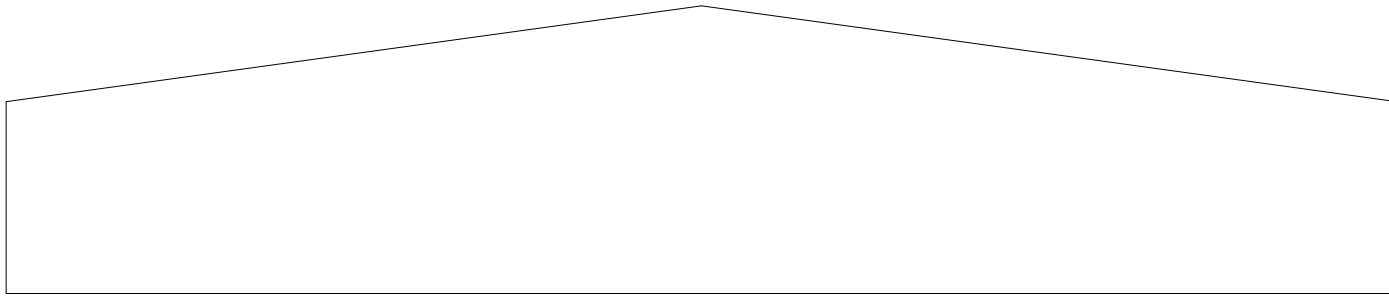

67001

EST. 1879  
**S T A R K**  
L U M B E R C O M P A N Y  
FINE WOOD MOULDING

924 W. 1st. Avenue  
Denver, CO 80223  
303-534-8263 Phone  
303-534-8266 Fax

|              |          |           |             |
|--------------|----------|-----------|-------------|
| Approved by: | MM/DD/YY |           |             |
| Drawn:       |          |           |             |
| File name:   |          | Scale 1:1 | Sheet 6-7-1 |

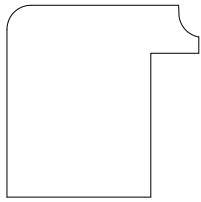

71001

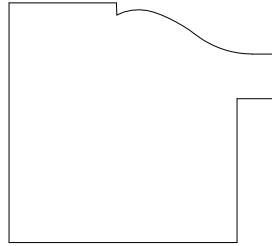

71005

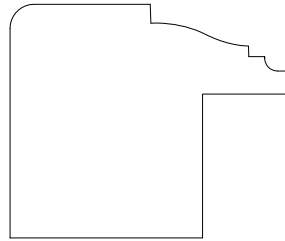

71009

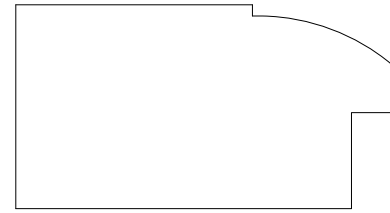

71013

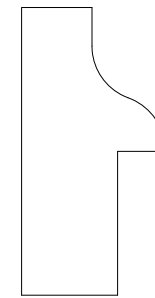

71017

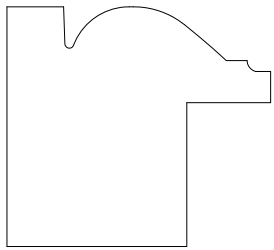

71002

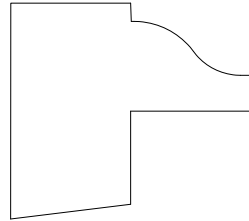

71006

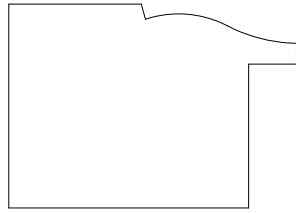

71010

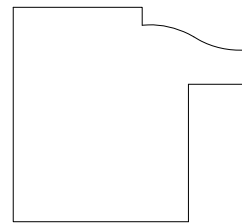

71014

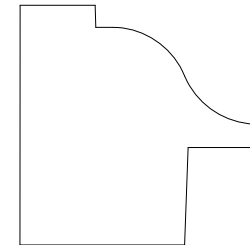

71018

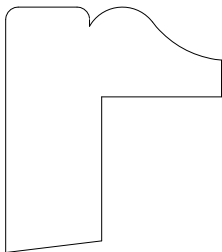

71003

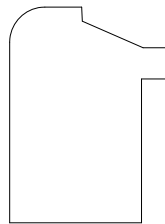

71007

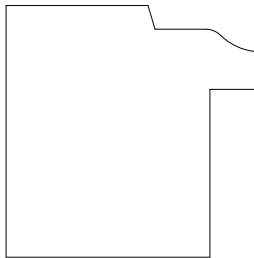

71011

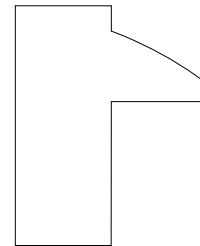

71015

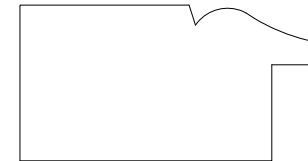

71019

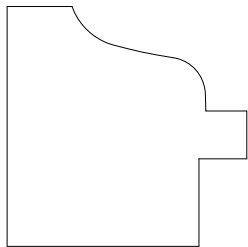

71004

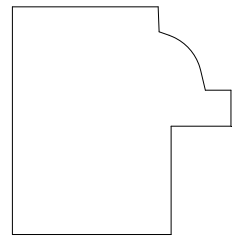

71008

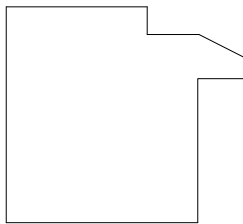

71012

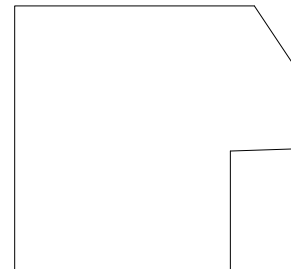

71016

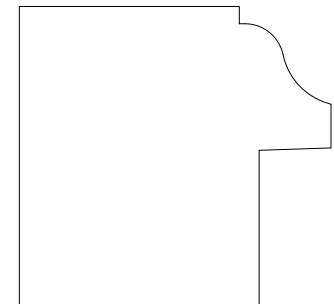

71020

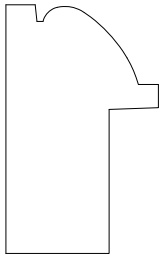

71021

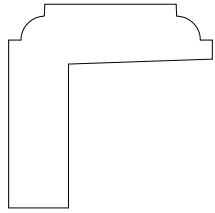

71025

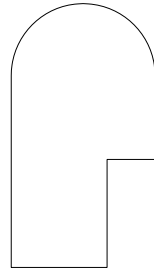

71029

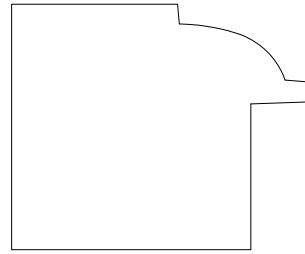

71030

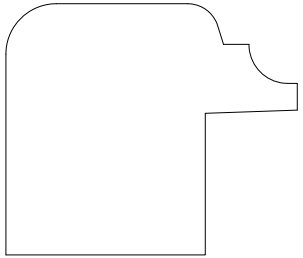

71022

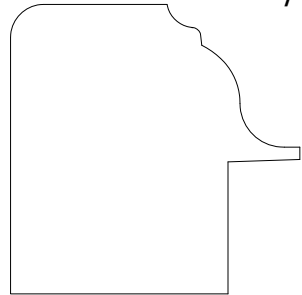

71026

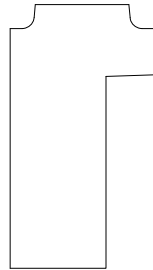

71031

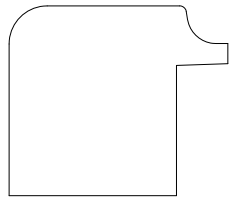

71023

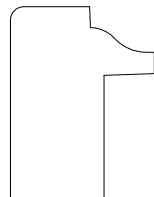

71027

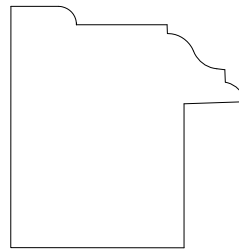

71032

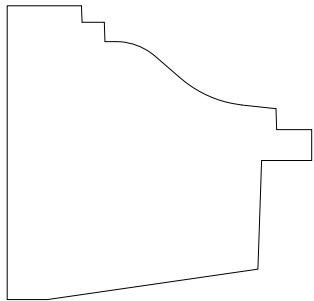

71024

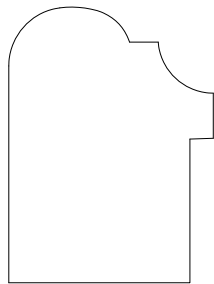

71028

EST. 1879

**S T A R K**

L U M B E R C O M P A N Y

FINE WOOD MOULDING

924 W. 1st. Avenue  
 Denver, CO 80223  
 303-534-8263 Phone  
 303-534-8266 Fax

|              |          |                       |
|--------------|----------|-----------------------|
| Approved by: | MM/DD/YY |                       |
| Drawn:       |          |                       |
| File name:   |          | Scale 1:1 Sheet 7-1-2 |

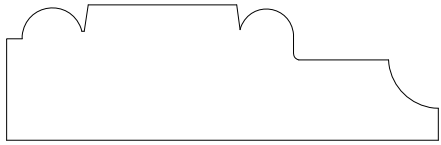

72001

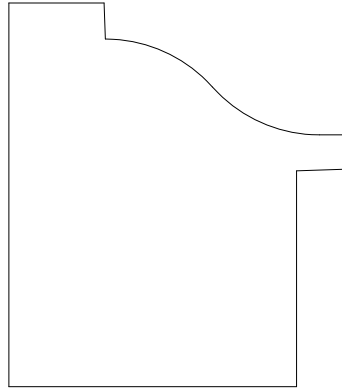

72004

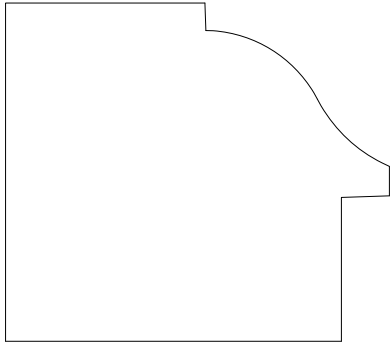

72002

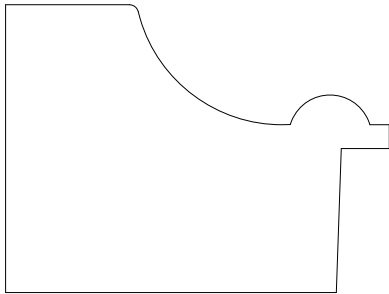

72003

EST. 1879

**S T A R K**

L U M B E R C O M P A N Y

FINE WOOD MOULDING

924 W. 1st. Avenue  
 Denver, CO 80223  
 303-534-8263 Phone  
 303-534-8266 Fax

|              |          |             |
|--------------|----------|-------------|
| Approved by: | MM/DD/YY |             |
| Drawn:       |          |             |
| File name:   |          | Scale 1:1   |
|              |          | Sheet 7-2-1 |



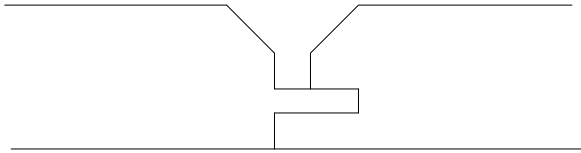

81001



81002



81003

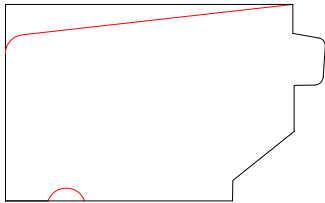

81004

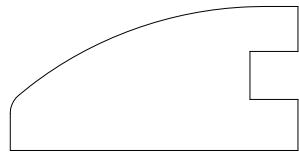

81005

EST. 1879

**S T A R K**

L U M B E R C O M P A N Y

FINE WOOD MOULDING

924 W. 1st. Avenue  
 Denver, CO 80223  
 303-534-8263 Phone  
 303-534-8266 Fax

|              |          |             |
|--------------|----------|-------------|
| Approved by: | MM/DD/YY |             |
| Drawn:       |          |             |
| File name:   |          | Scale 1:1   |
|              |          | Sheet 8-1-1 |



82001



82002

EST. 1879

**S T A R K**

L U M B E R C O M P A N Y

FINE WOOD MOULDING

924 W. 1st. Avenue  
Denver, CO 80223  
303-534-8263 Phone  
303-534-8266 Fax

Approved by:

MM/DD/YY

Drawn:

File name:

Scale 1:1

Sheet 8-2-1

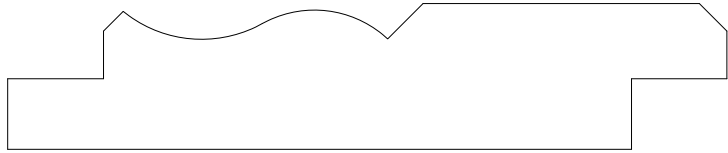

83001

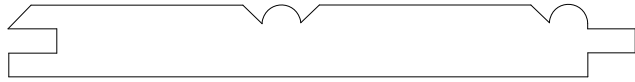

83002



83003

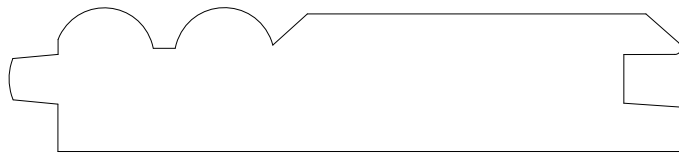

83004



83005

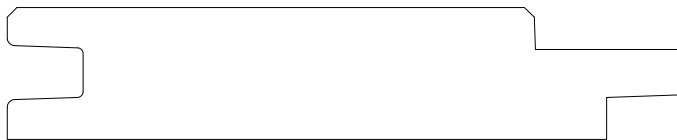

83006

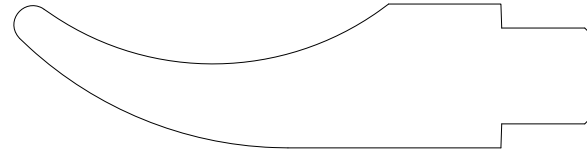

83007



84001

|   |  |
|---|--|
|  <p><b>S T A R K</b><br/>L U M B E R C O M P A N Y<br/>FINE WOOD MOULDING</p> | 924 W. 1st. Avenue<br>Denver, CO 80223<br>303-534-8263 Phone<br>303-534-8266 Fax |
|   |  |

|  |
|--|
|  |
|--|

|              |          |
|--------------|----------|
| Approved by: | MM/DD/YY |
| Drawn:       |          |
| File name:   |          |

|           |             |
|-----------|-------------|
| Scale 1:1 | Sheet 8-4-1 |
|-----------|-------------|

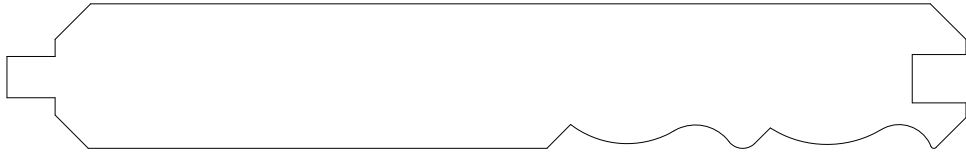

85001

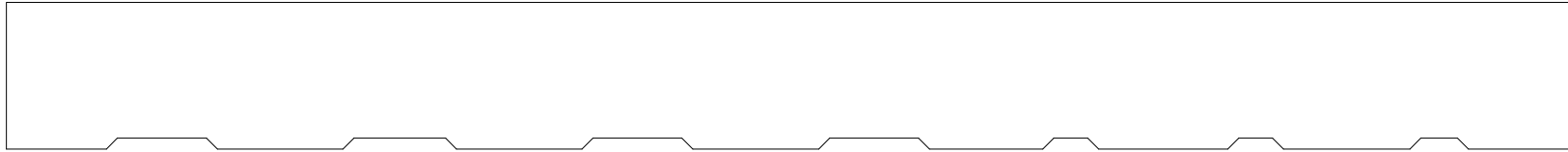

85002



85003

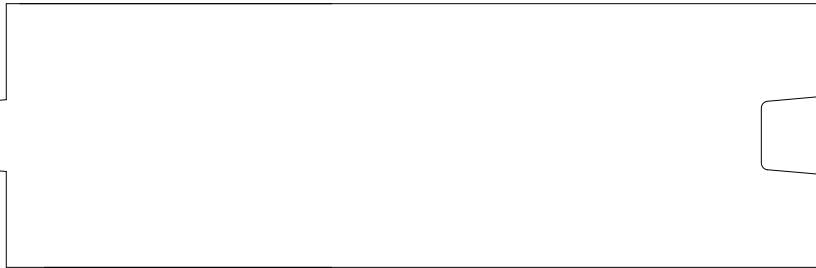

85004

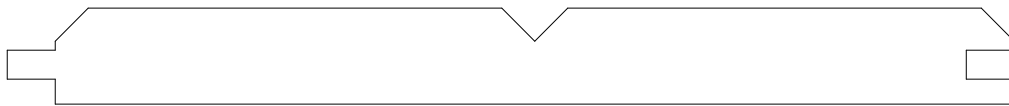

85005

EST. 1879

**S T A R K**

L U M B E R C O M P A N Y

FINE WOOD MOULDING

924 W. 1st. Avenue  
 Denver, CO 80223  
 303-534-8263 Phone  
 303-534-8266 Fax

|              |          |           |             |
|--------------|----------|-----------|-------------|
| Approved by: | MM/DD/YY |           |             |
| Drawn:       |          |           |             |
| File name:   |          | Scale 1:1 | Sheet 8-5-1 |



85006



85007

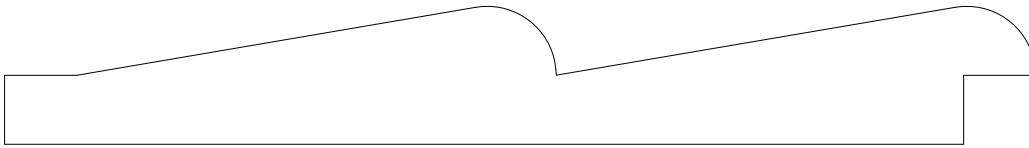

85008

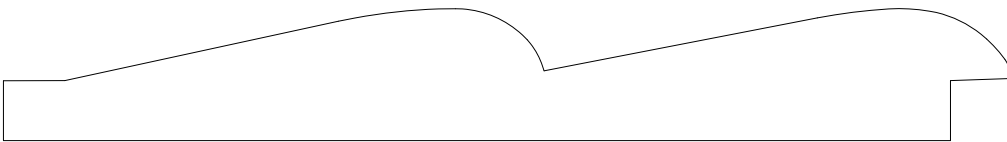

85009

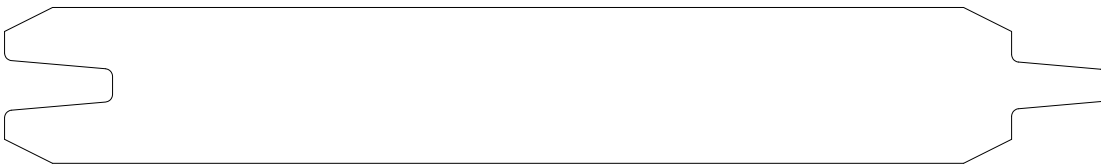

85010

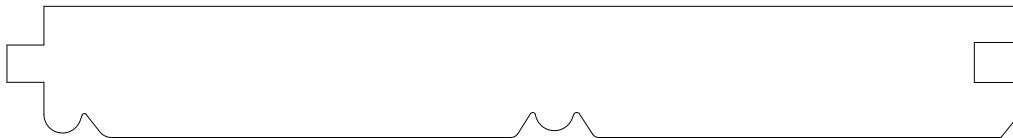

85011

EST. 1879

**S T A R K**

L U M B E R C O M P A N Y

FINE WOOD MOULDING

924 W. 1st. Avenue  
 Denver, CO 80223  
 303-534-8263 Phone  
 303-534-8266 Fax

|              |          |                       |
|--------------|----------|-----------------------|
| Approved by: | MM/DD/YY |                       |
| Drawn:       |          |                       |
| File name:   |          | Scale 1:1 Sheet 8-5-2 |



86001

EST. 1879  
**S T A R K**  
L U M B E R C O M P A N Y  
FINE WOOD MOULDING

924 W. 1st. Avenue  
Denver, CO 80223  
303-534-8263 Phone  
303-534-8266 Fax

|              |          |           |             |
|--------------|----------|-----------|-------------|
| Approved by: | MM/DD/YY |           |             |
| Drawn:       |          |           |             |
| File name:   |          | Scale 1:1 | Sheet 8-6-1 |

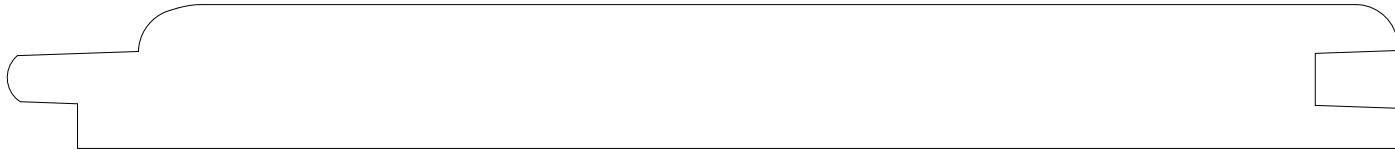

87001

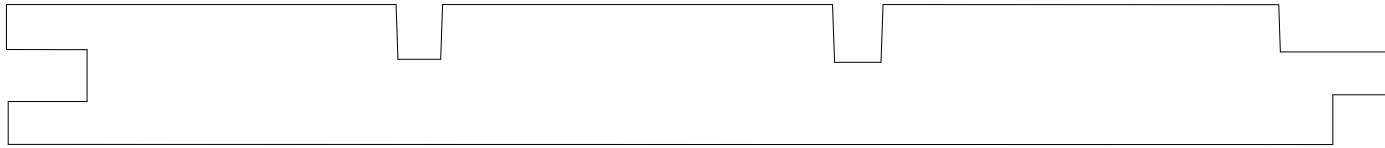

87002

|   |  |              |           |
|---|--|--------------|-----------|
| <p>EST. 1879</p> <p><b>S T A R K</b></p> <p>L U M B E R C O M P A N Y</p> <p>FINE WOOD MOULDING</p> | <p>924 W. 1st. Avenue<br/>Denver, CO 80223<br/>303-534-8263 Phone<br/>303-534-8266 Fax</p> | Approved by: | MM/DD/YY  |
|   |  | Drawn:       |           |
|   |  | File name:   | Scale 1:1 |

|  |
|--|
|  |
|--|

|  |
|--|
|  |
|--|

|           |             |
|-----------|-------------|
| Scale 1:1 | Sheet 8-7-1 |
|-----------|-------------|





88001

EST. 1879  
**S T A R K**  
L U M B E R C O M P A N Y  
FINE WOOD MOULDING

924 W. 1st. Avenue  
Denver, CO 80223  
303-534-8263 Phone  
303-534-8266 Fax

|              |          |           |             |
|--------------|----------|-----------|-------------|
| Approved by: | MM/DD/YY |           |             |
| Drawn:       |          |           |             |
| File name:   |          | Scale 1:1 | Sheet 8-8-1 |



89001



89002

EST. 1879  
**S T A R K**  
L U M B E R C O M P A N Y  
FINE WOOD MOULDING

924 W. 1st. Avenue  
Denver, CO 80223  
303-534-8263 Phone  
303-534-8266 Fax

|              |          |           |             |
|--------------|----------|-----------|-------------|
| Approved by: | MM/DD/YY |           |             |
| Drawn:       |          |           |             |
| File name:   |          | Scale 1:1 | Sheet 8-9-1 |

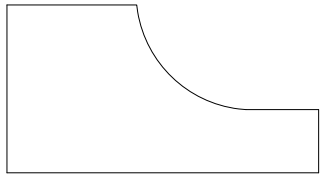

91001

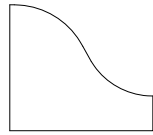

91008

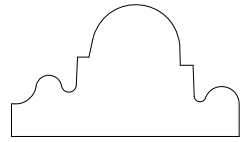

91013

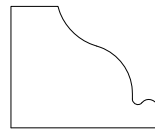

91014

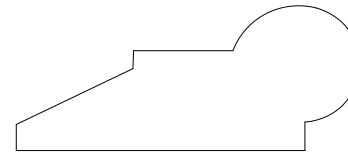

91020

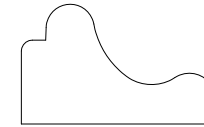

91025

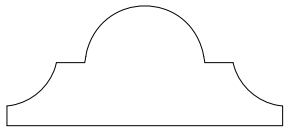

91002

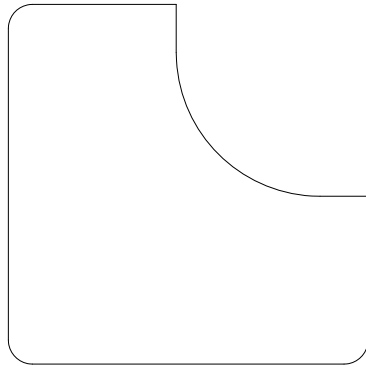

91009

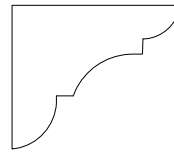

91015

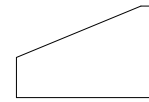

91021

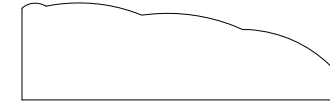

91026

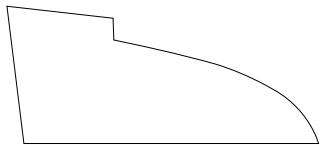

91003

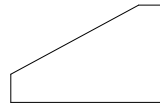

91016

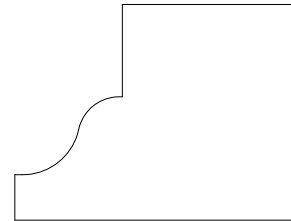

91022

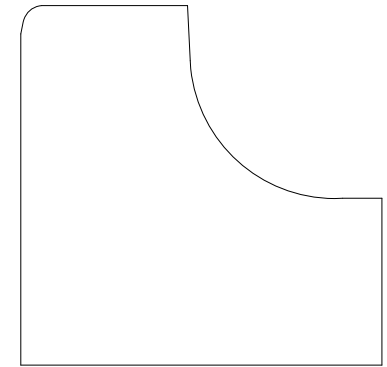

91027

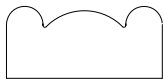

91004

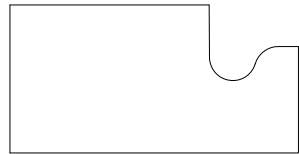

91010

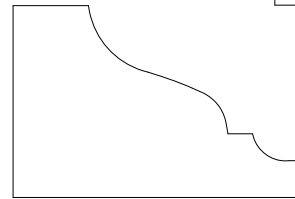

91017

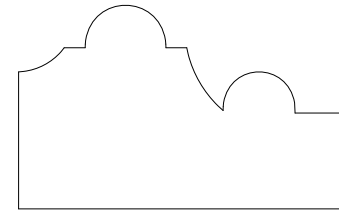

91023

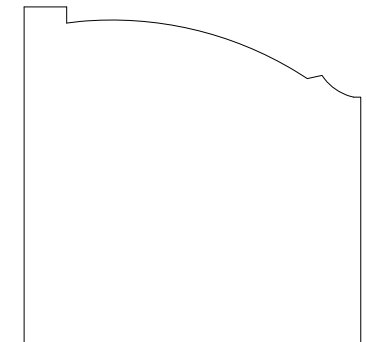

91028

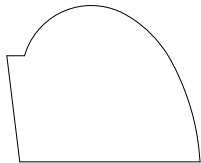

91005

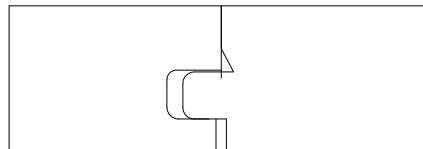

91011

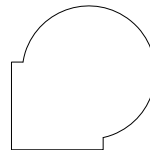

91018

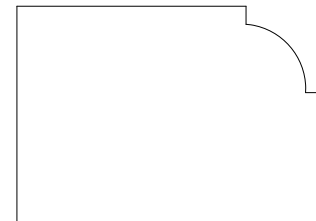

91024

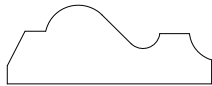

91006

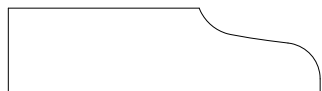

91012

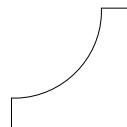

91019

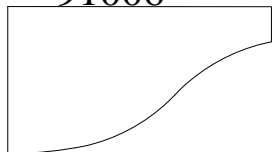

91007



91029

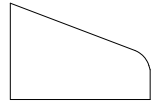

91036

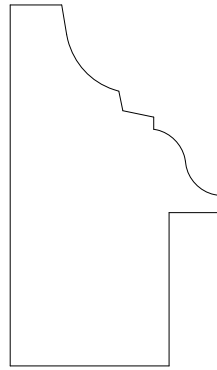

91043

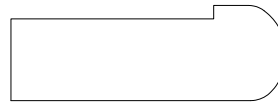

91047

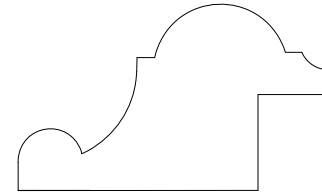

91052

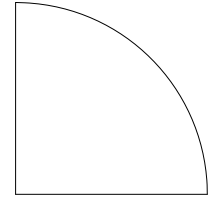

91058

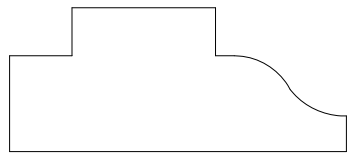

91030

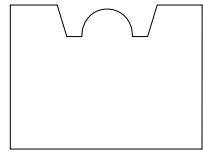

91037

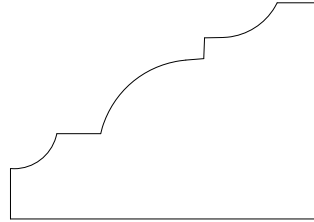

91048

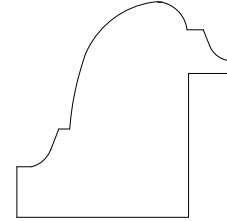

91053

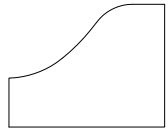

91031

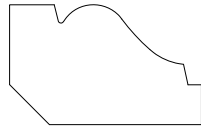

91038

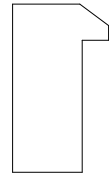

91044



91049

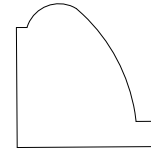

91054

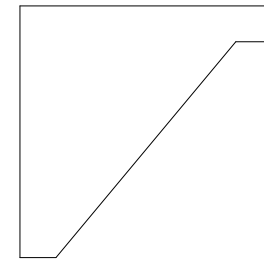

91055



91059

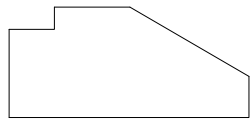

91032

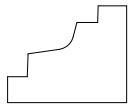

91039

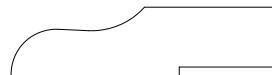

91045

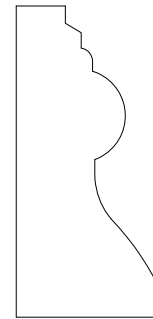

91050

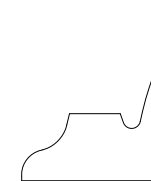

91056

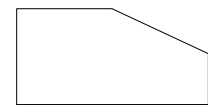

91060

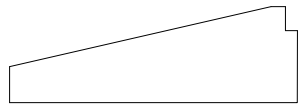

91033



91040

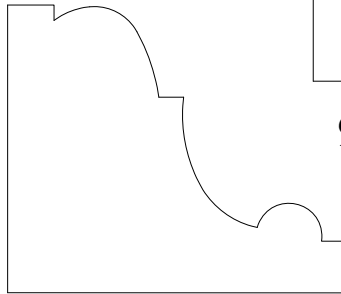

91046



91051

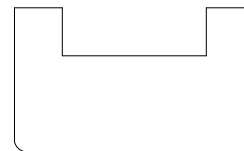

91057

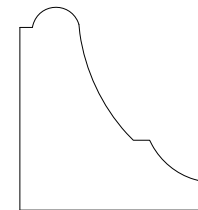

91061

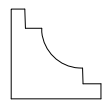

91034



91041

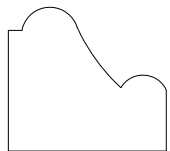

91035

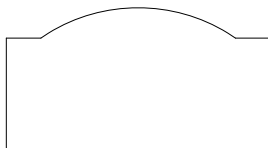

91042



91062

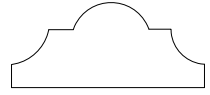

91063

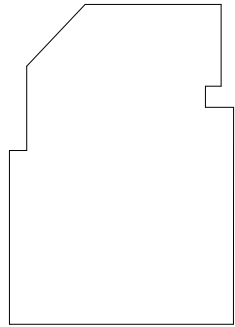

91064

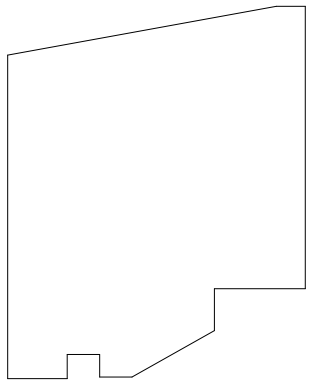

91065

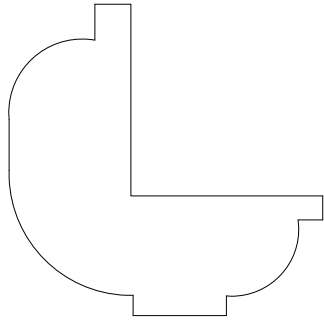

91066

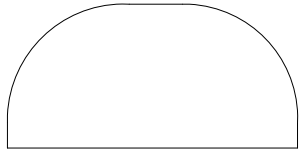

91067

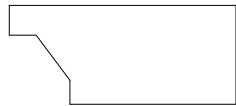

91068

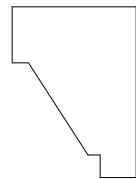

91069

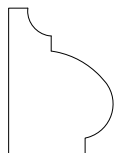

91070

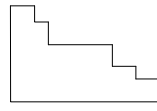

91071

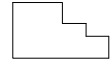

91072

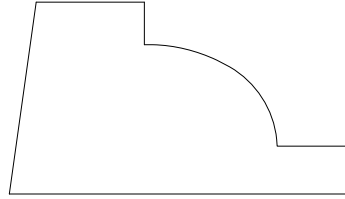

91073

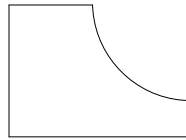

91074

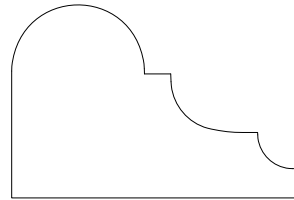

91075

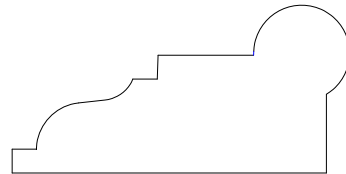

91076

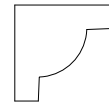

91077

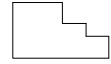

91072

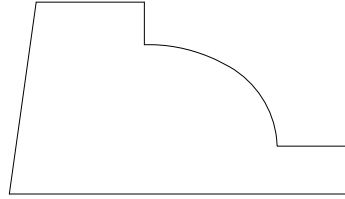

91073

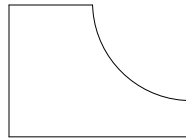

91074

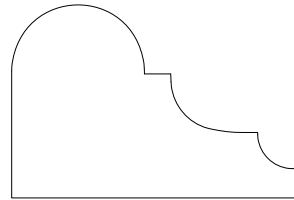

91075

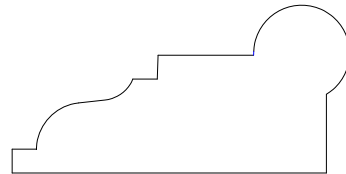

91076

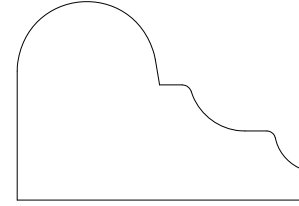

91078

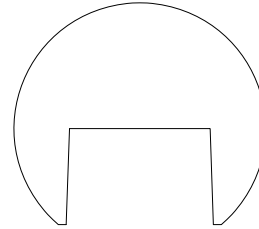
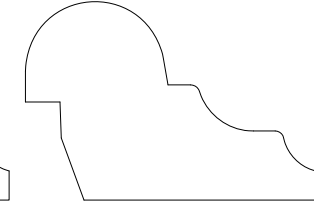

91079

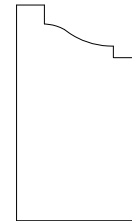
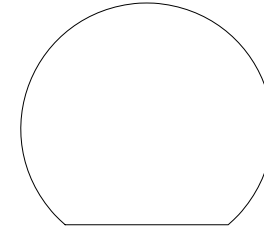

91080



91083

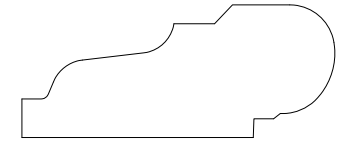

91084

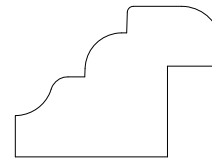

91081

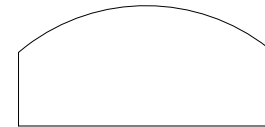

91085



91086



91082



91087

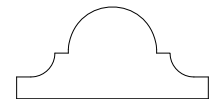

91088

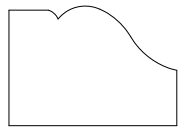

91089



91095



91101



91107

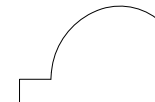

91113

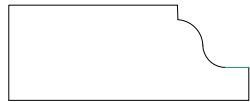

91090



91102

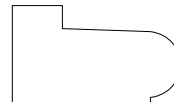

91108

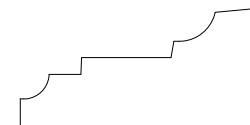

91114

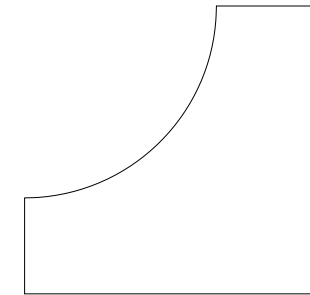

91115

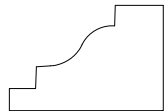

91091



91096

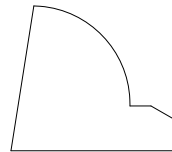

91103



91109

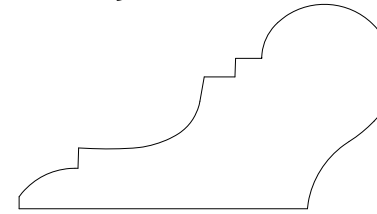

91116

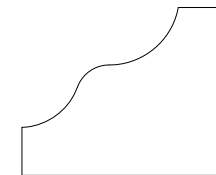

91117

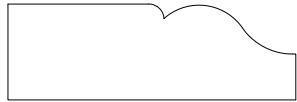

91092

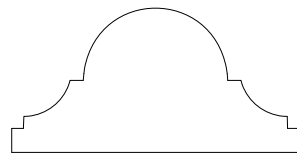

91097

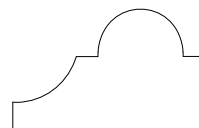

91104

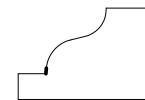

91110

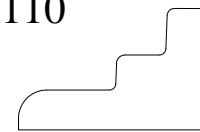

91111

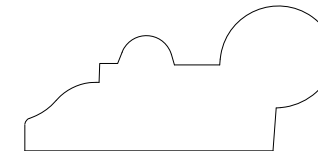

91118



91119

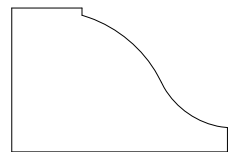

91093

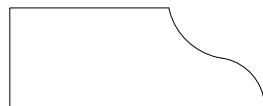

91098

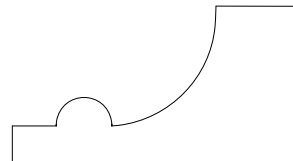

91105

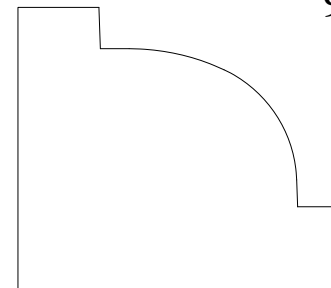

91112

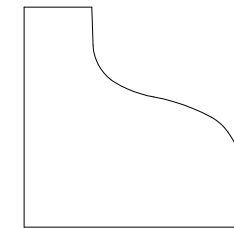

91120

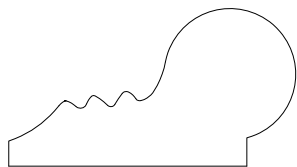

91094



91099

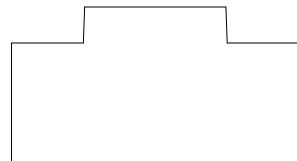

91100

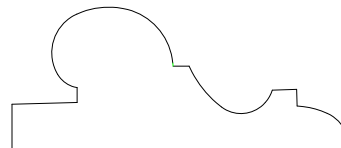

91106

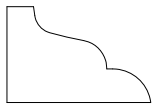

91121

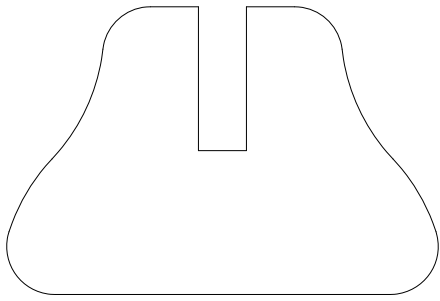

91127

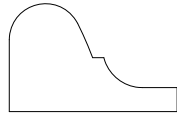

91134

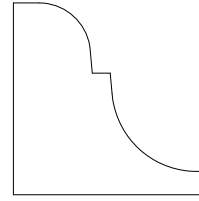

91139

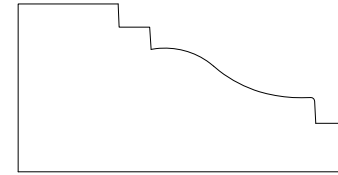

91145

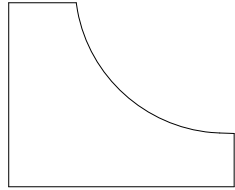

91122

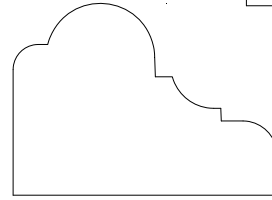

91135

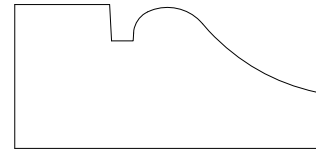

91140

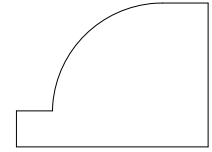

91146

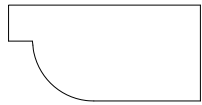

91123

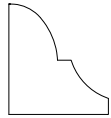

91129

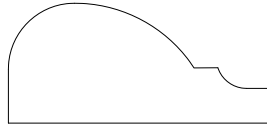

91136

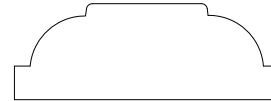

91141

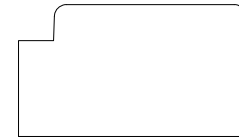

91147

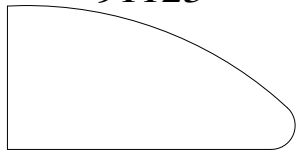

91124

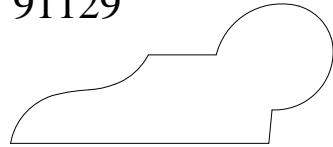

91130

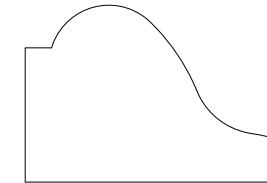

91137

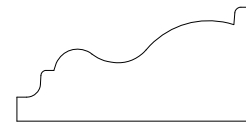

91142

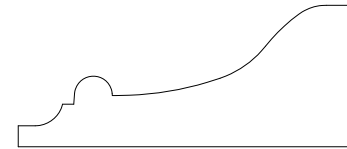

91148

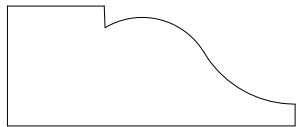

91125

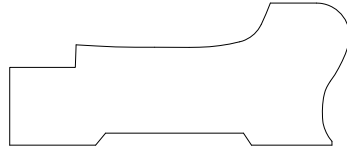

91131

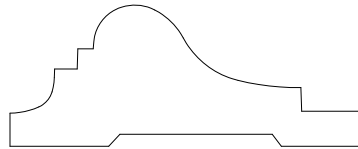

91138

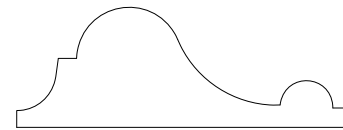

91143

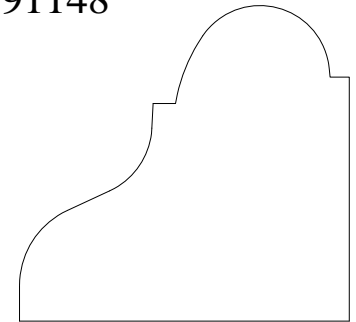

91149



91126

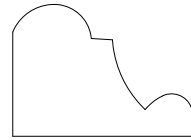

91132

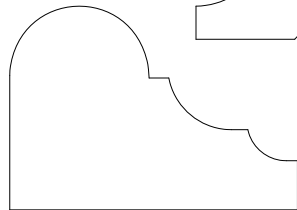

91133

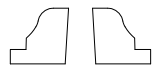

91128



91144

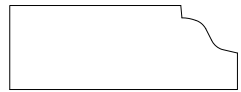

91151

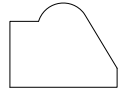

91152

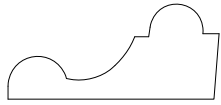

91153

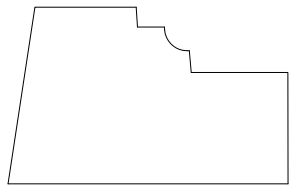

91154



91155

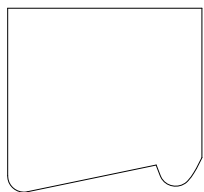

91156

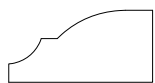

91157

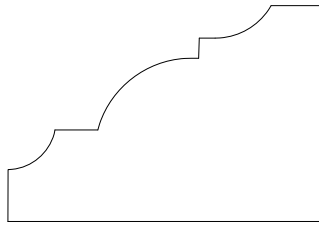

91158

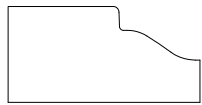

91159



91160

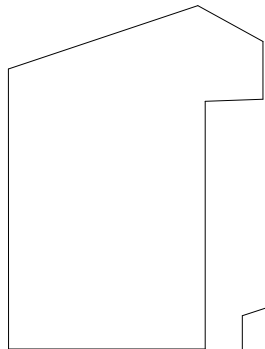

91161

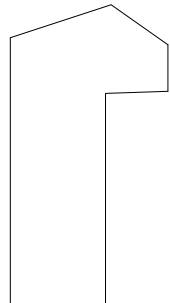

91162

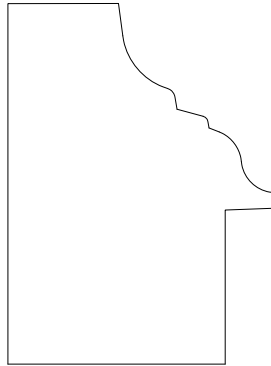

91163

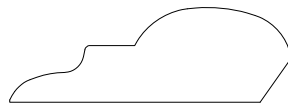

91164

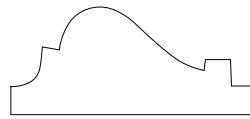

91165

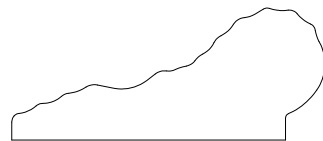

91166

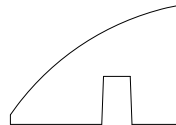

91167

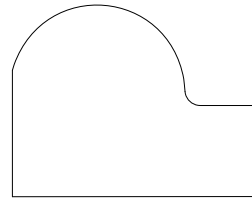

91168

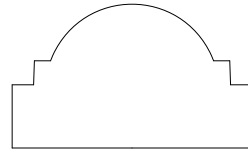

91169

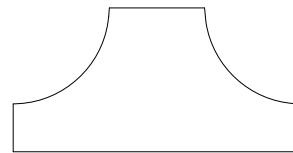

91170

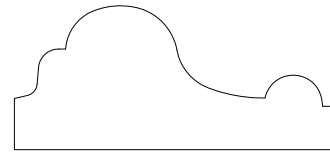

91171

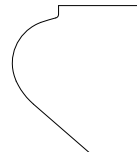

91172

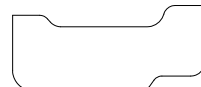

91173

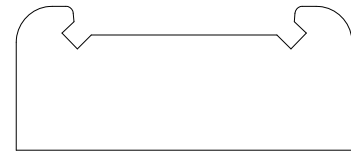

91174

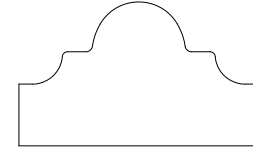

91175

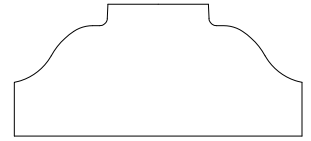

91176



91177

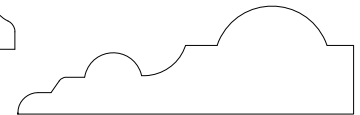

91178

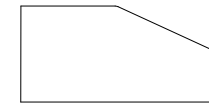

91179

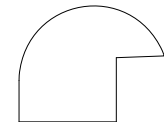

91181



91180

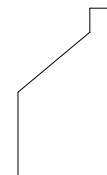

91182



91183



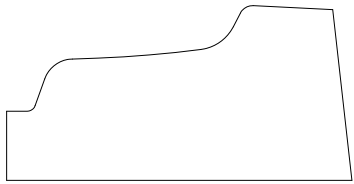

91184

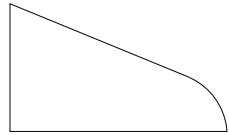

91185



91186

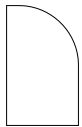

91187

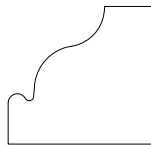

91188

|  |  |              |          |           |             |
|--|--|--------------|----------|-----------|-------------|
|  | 924 W. 1st. Avenue<br>Denver, CO 80223<br>303-534-8263 Phone<br>303-534-8266 Fax | Approved by: | MM/DD/YY |           |             |
|  |  | Drawn:       |          |           |             |
|  |  | File name:   |          | Scale 1:1 | Sheet 9-1-7 |

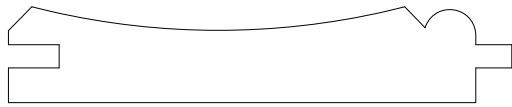

92001



92006

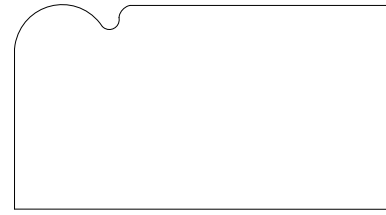

92010

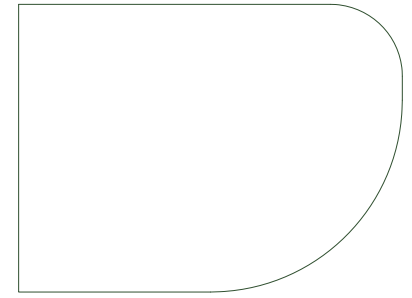

92015

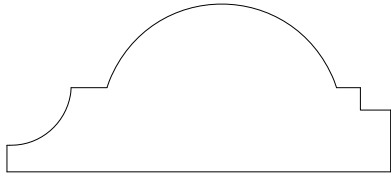

92002

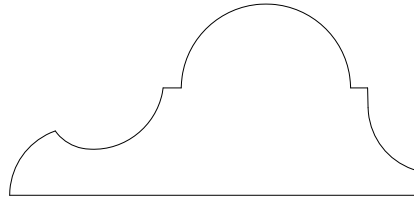

92007

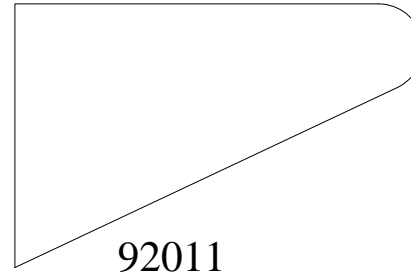

92011

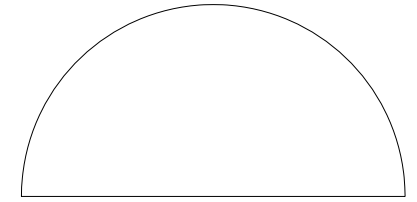

92016

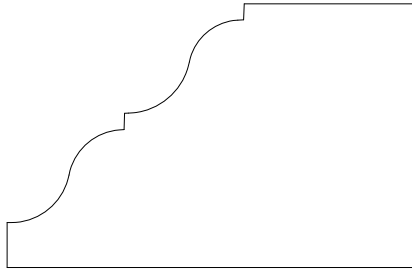

92003

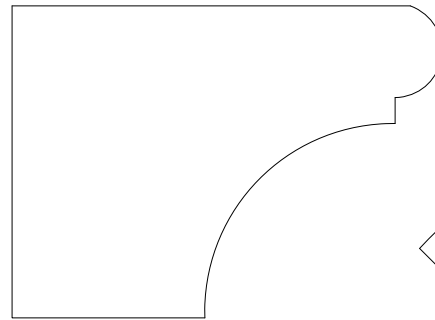

92008

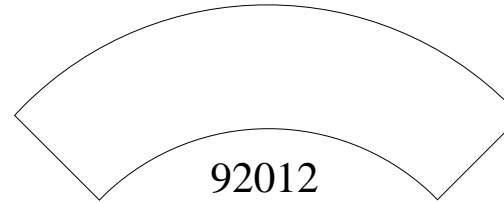

92012

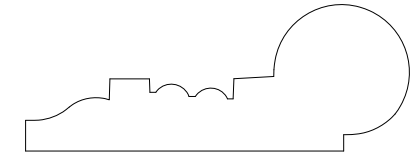

92017

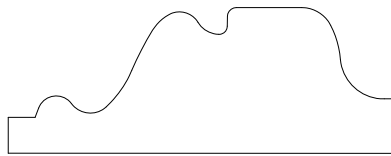

92004

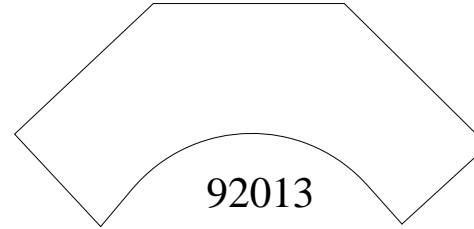

92013

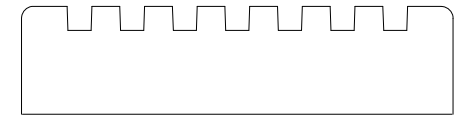

92018



92005

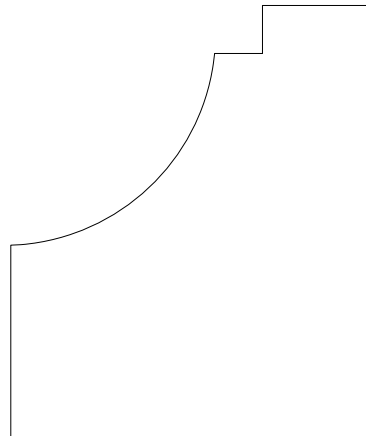

92009



92014

EST. 1879

**S T A R K**

L U M B E R C O M P A N Y

FINE WOOD MOULDING

924 W. 1st. Avenue  
 Denver, CO 80223  
 303-534-8263 Phone  
 303-534-8266 Fax

|              |          |             |
|--------------|----------|-------------|
| Approved by: | MM/DD/YY |             |
| Drawn:       |          |             |
| File name:   |          | Scale 1:1   |
|              |          | Sheet 9-2-1 |

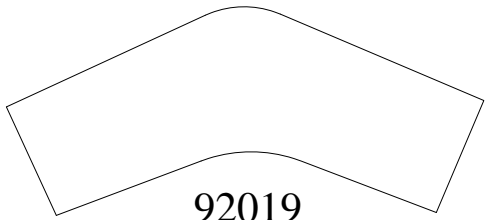

92019



92023

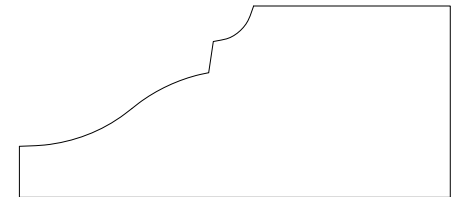

92027

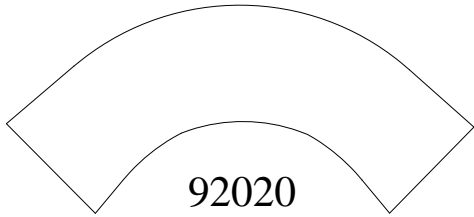

92020

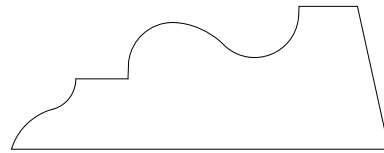

92024

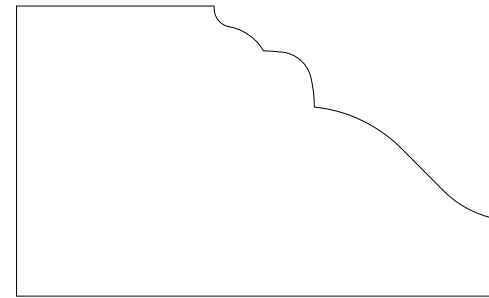

92028

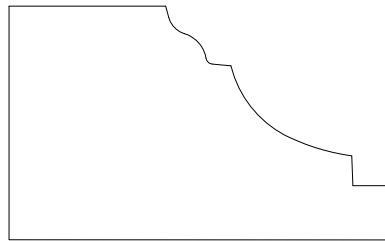

92021

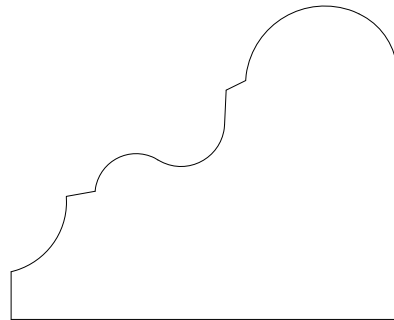

92025

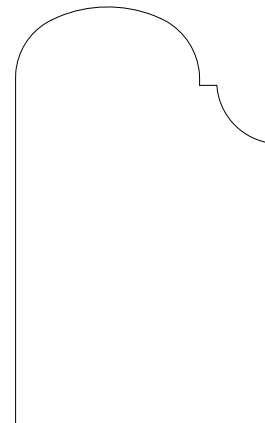

92029



92030

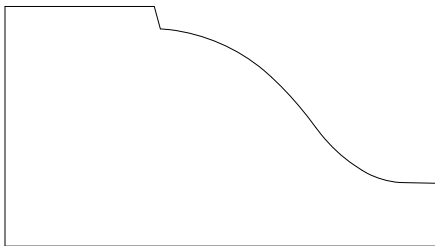

92022

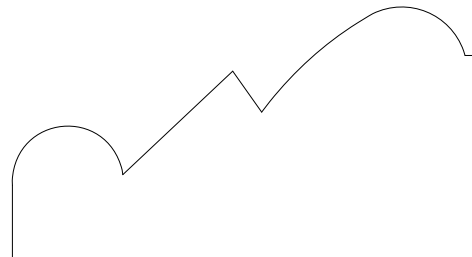

92026

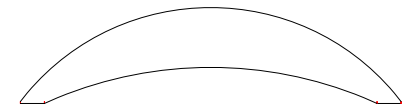

92031

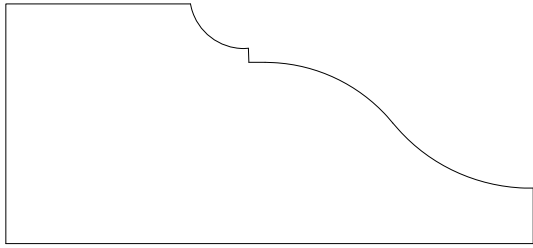

92032

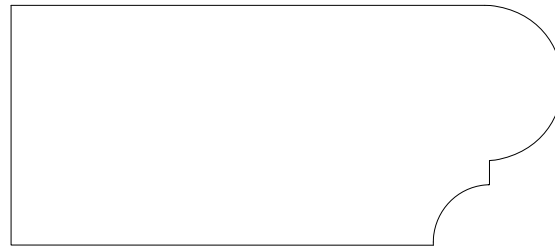

92036

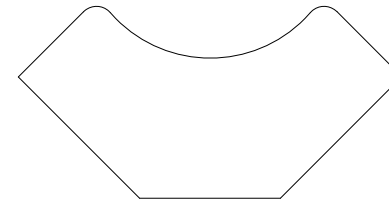

92040

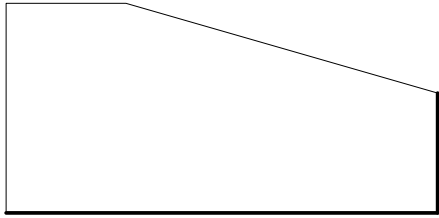

92033

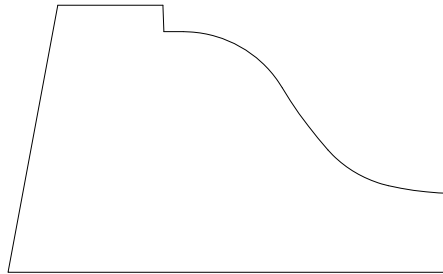

92037

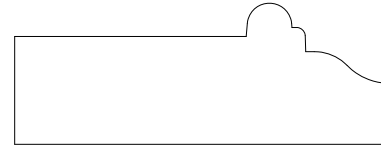

92041

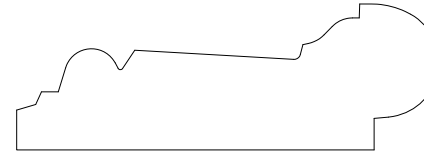

92042

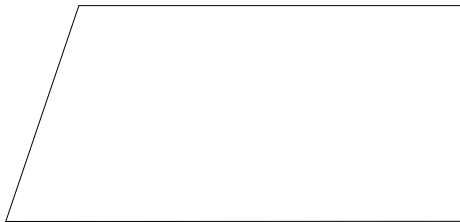

92034

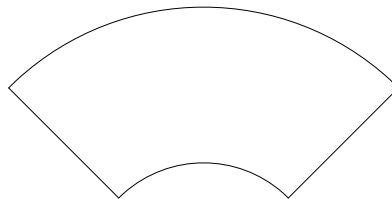

92038

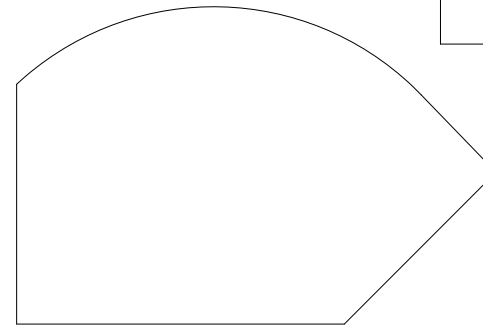

92043



92044



92035

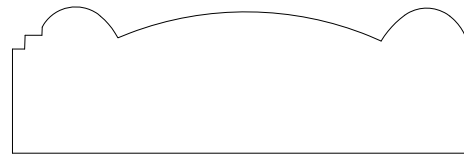

92039

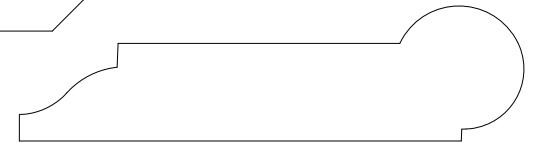

92045

EST. 1879

**S T A R K**

LUMBER COMPANY

FINE WOOD MOULDING

924 W. 1st. Avenue  
 Denver, CO 80223  
 303-534-8263 Phone  
 303-534-8266 Fax

|              |          |                       |
|--------------|----------|-----------------------|
| Approved by: | MM/DD/YY |                       |
| Drawn:       |          |                       |
| File name:   |          | Scale 1:1 Sheet 9-2-3 |

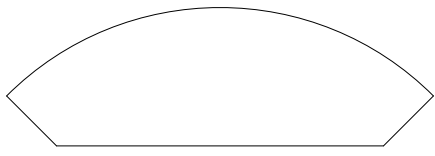

92046



92051

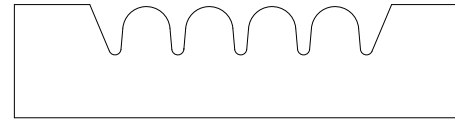

92056

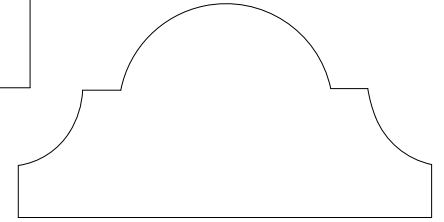

92060

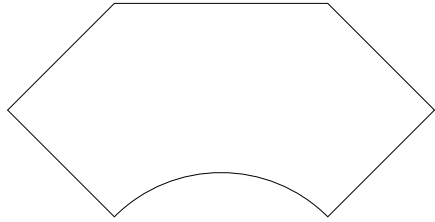

92047

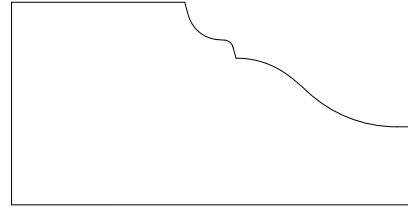

92052

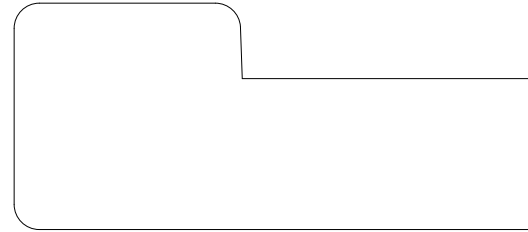

92057

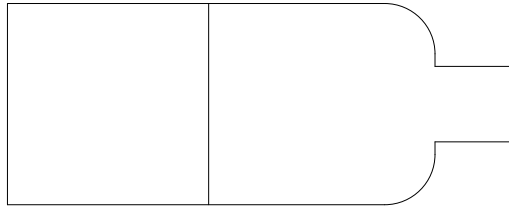

92048

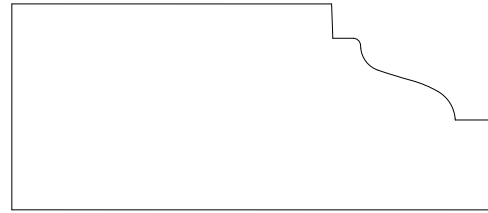

92053

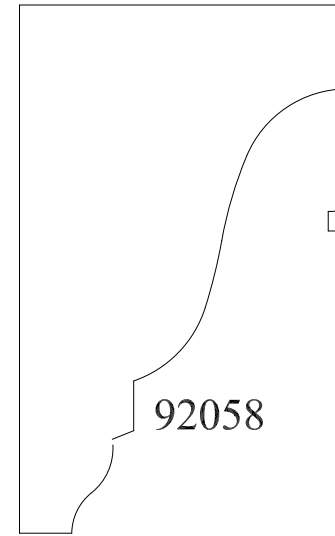

92058

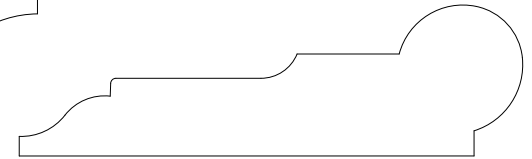

92061

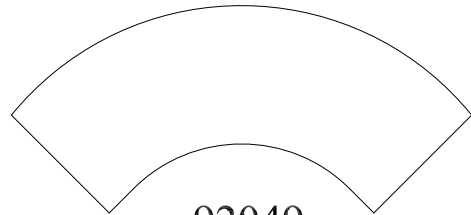

92049

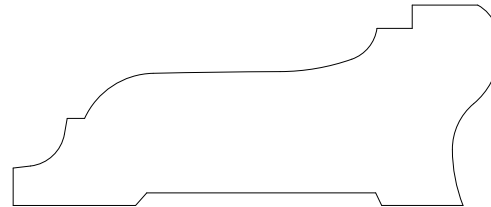

92054

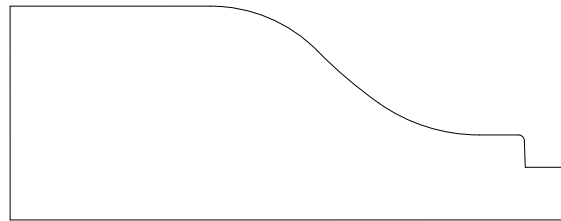

92050



92055

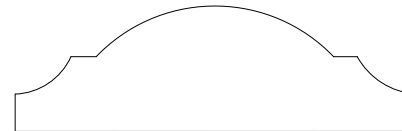

92059



EST. 1879  
924 W. 1st. Avenue  
Denver, CO 80223  
303-534-8263  
Phone

303-534-8266 Fax

|              |          |                         |
|--------------|----------|-------------------------|
| Approved by: | MM/DD/YY |                         |
| Drawn:       |          |                         |
| File name:   |          | Scale 1:1   Sheet 9-2-4 |

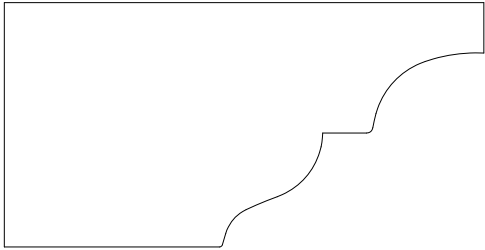

92063

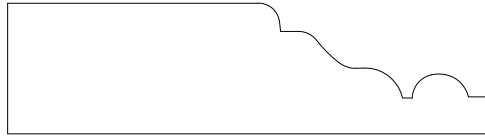

92067

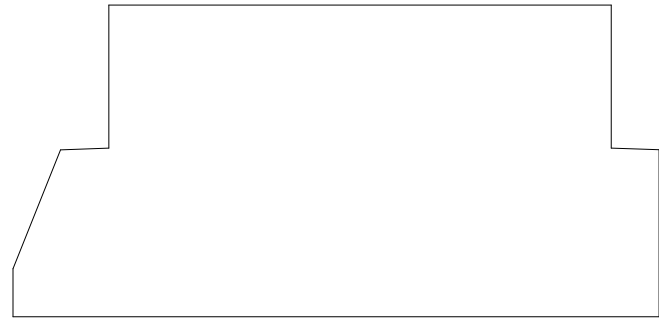

92072

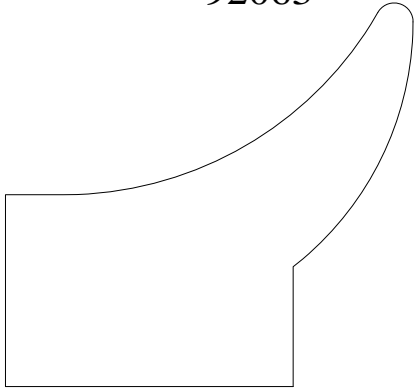

92064

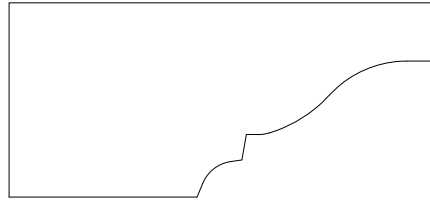

92068

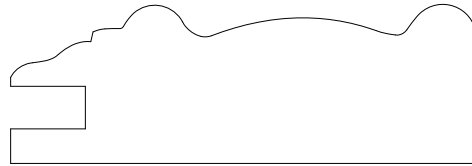

92069

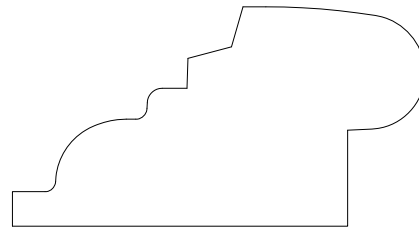

92073

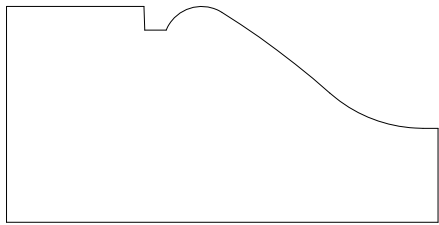

92065



92070

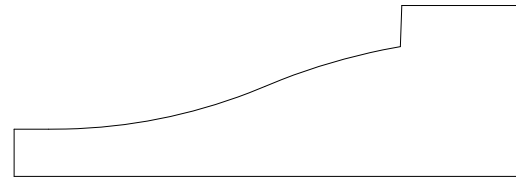

92074

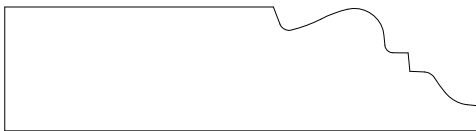

92066

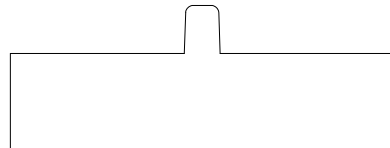

92071



92075

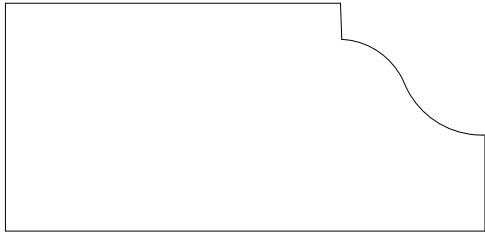

92076

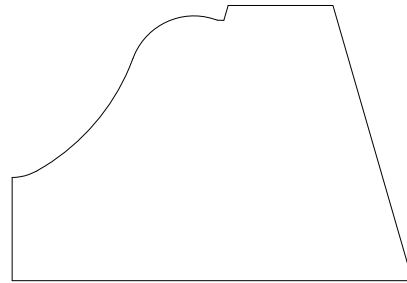

92079

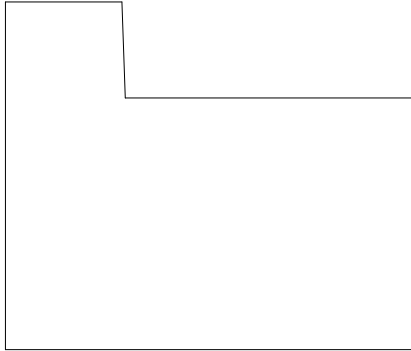

92077

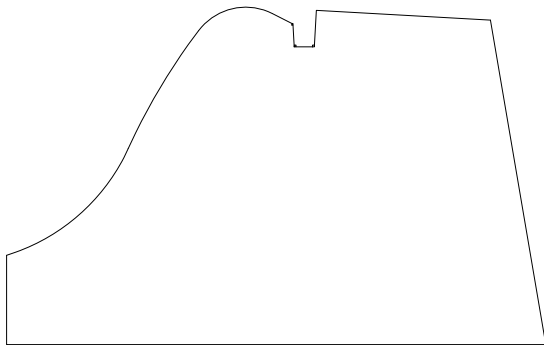

92078



924 W. 1st. Avenue  
Denver, CO 80223  
303-534-8263 Phone  
303-534-8266 Fax

|              |          |           |             |
|--------------|----------|-----------|-------------|
| Approved by: | MM/DD/YY |           |             |
| Drawn:       |          |           |             |
| File name:   |          | Scale 1:1 | Sheet 9-2-6 |

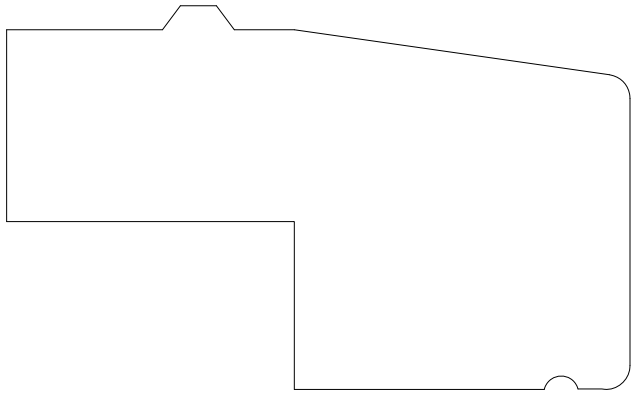

93001



93004

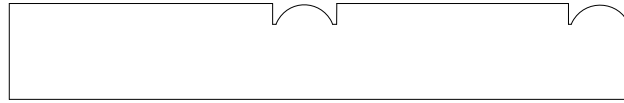

93005



93006

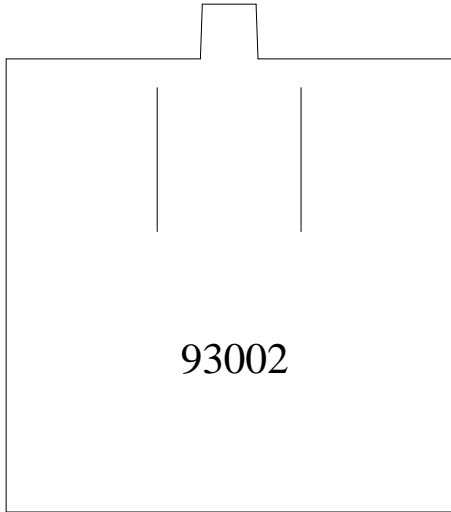

93002

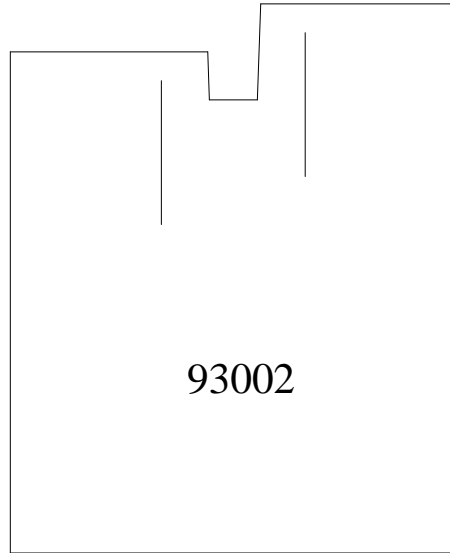

93002

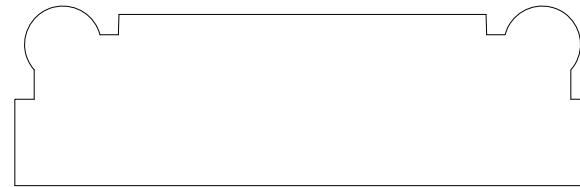

93007

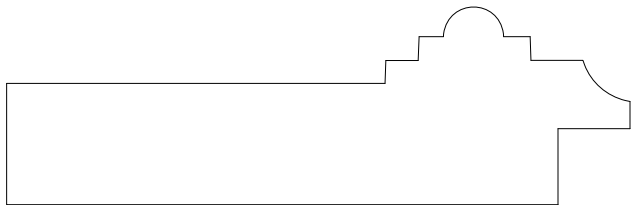

93003

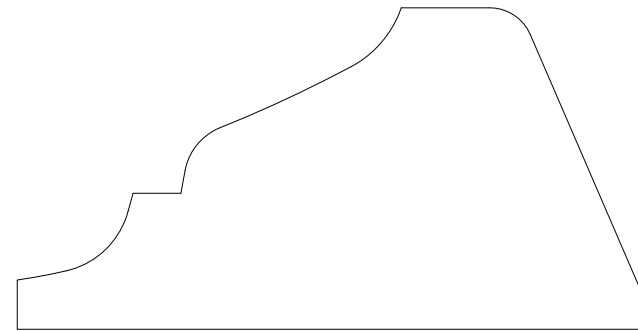

93008



924 W. 1st. Avenue  
Denver, CO 80223  
303-534-8263 Phone  
303-534-8266 Fax

|              |          |             |
|--------------|----------|-------------|
| Approved by: | MM/DD/YY |             |
| Drawn:       |          |             |
| File name:   |          | Scale 1:1   |
|              |          | Sheet 9-3-1 |



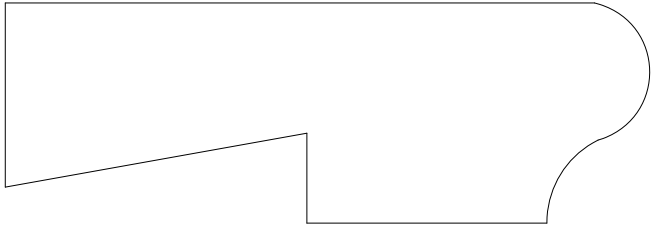

93009

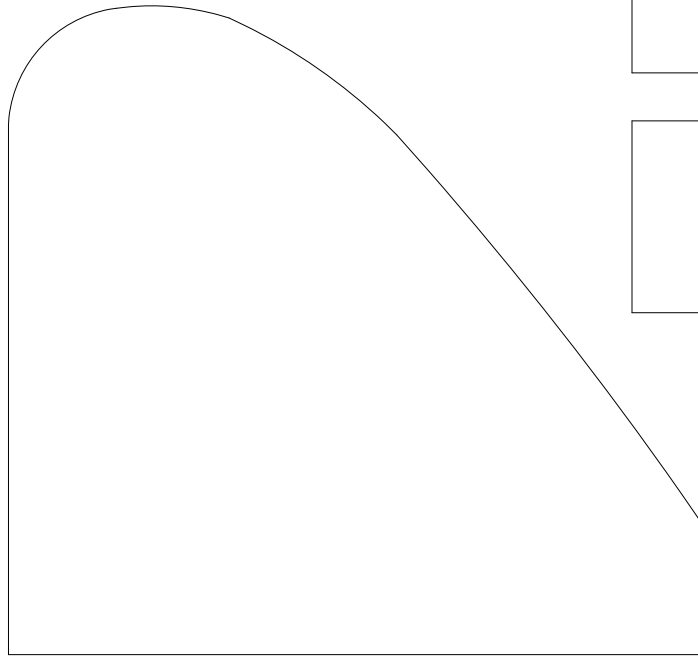

93011

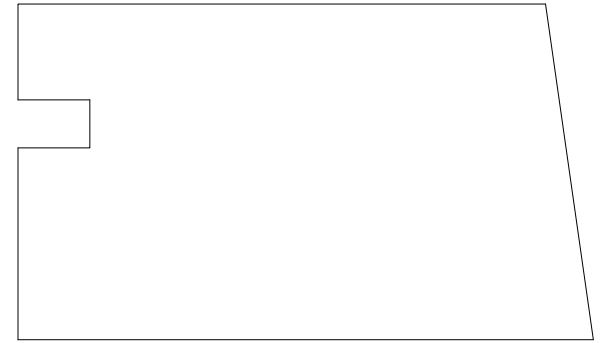

93014

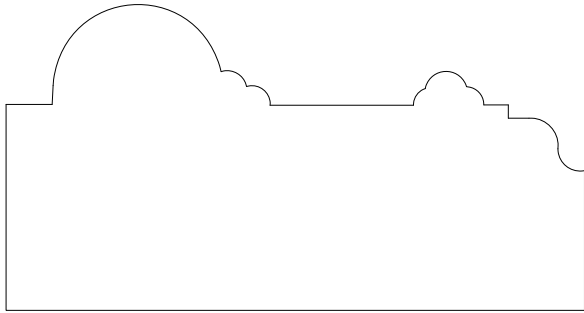

93010

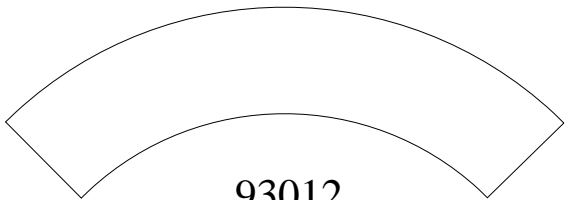

93012

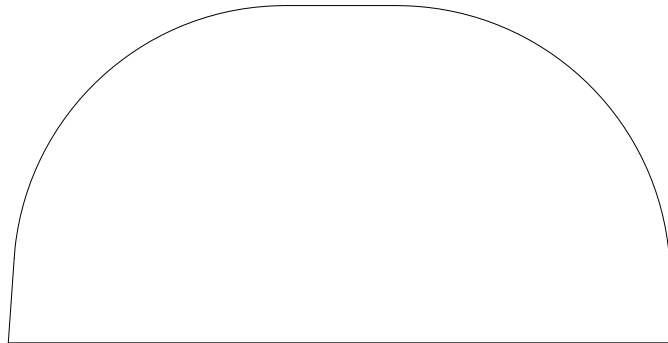

93015



93013



924 W. 1st. Avenue  
Denver, CO 80223  
303-534-8263 Phone  
303-534-8266 Fax

|              |          |             |
|--------------|----------|-------------|
| Approved by: | MM/DD/YY |             |
| Drawn:       |          |             |
| File name:   |          | Scale 1:1   |
|              |          | Sheet 9-3-2 |

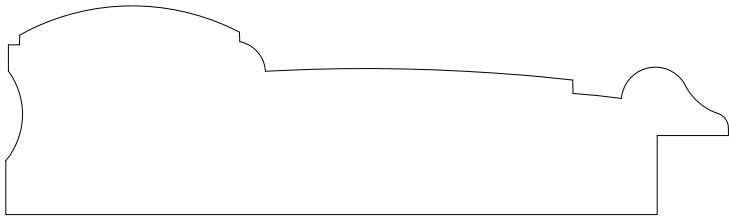

93016

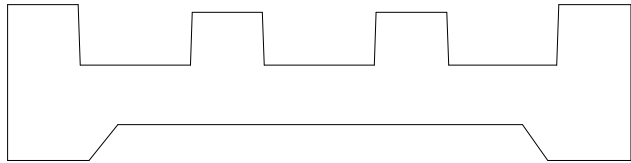

93017

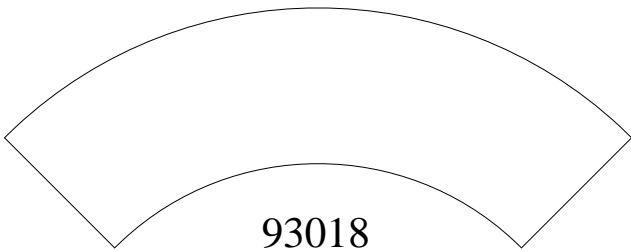

93018



93019

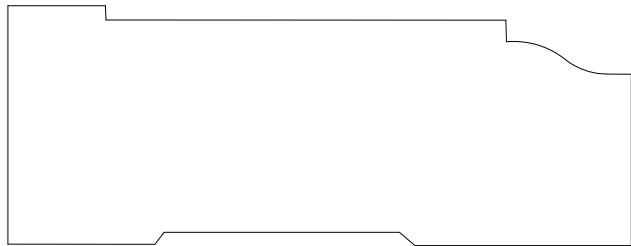

93020

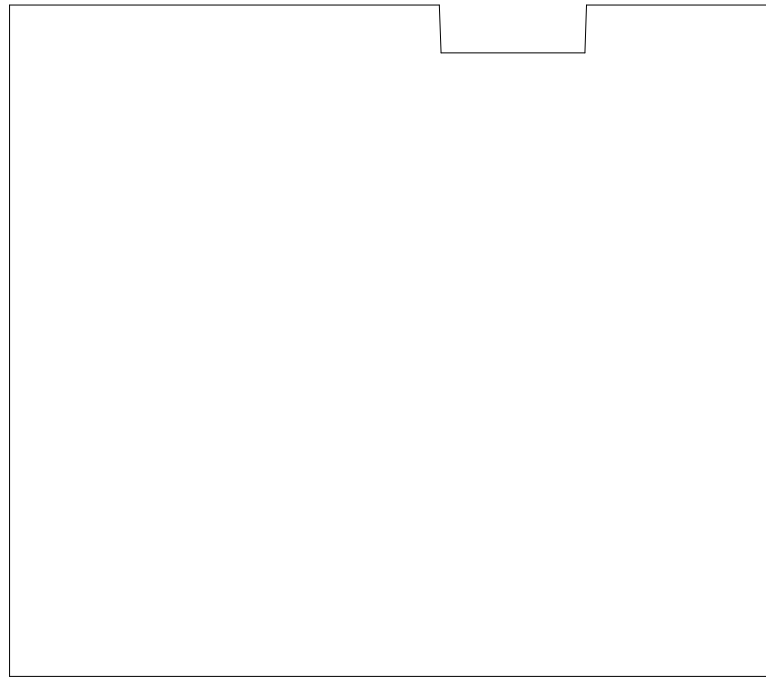

93021

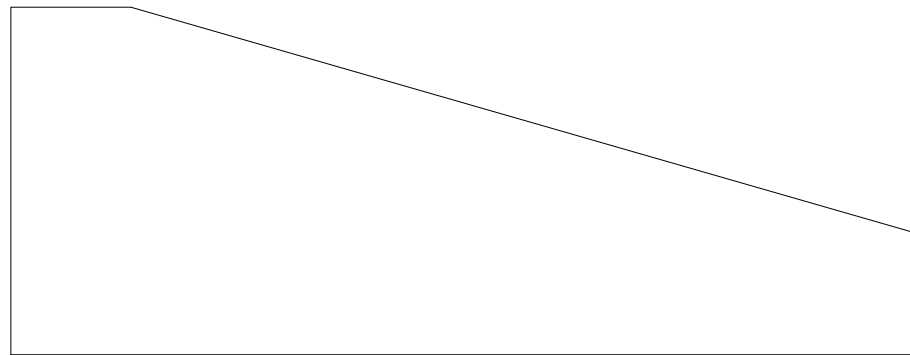

93022

EST. 1879

**S T A R K**

L U M B E R C O M P A N Y

FINE WOOD MOULDING

924 W. 1st. Avenue  
 Denver, CO 80223  
 303-534-8263 Phone  
 303-534-8266 Fax

|              |          |           |             |
|--------------|----------|-----------|-------------|
| Approved by: | MM/DD/YY |           |             |
| Drawn:       |          |           |             |
| File name:   |          | Scale 1:1 | Sheet 9-3-3 |

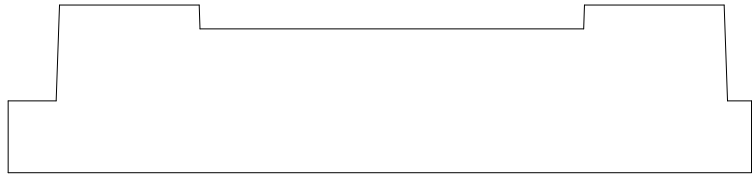

93023

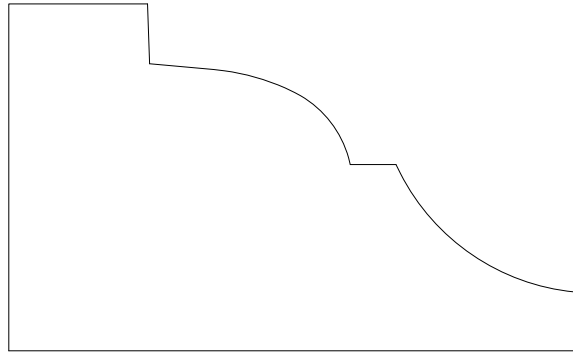

93027

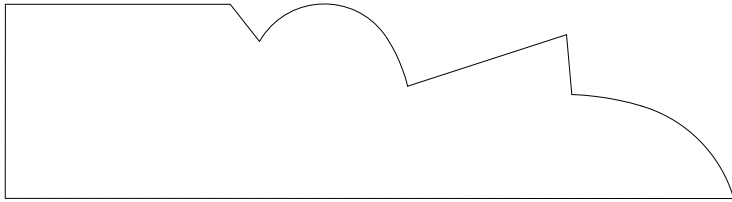

93024

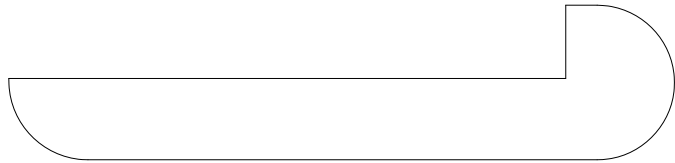

93025



93026



93028



924 W. 1st. Avenue  
Denver, CO 80223  
303-534-8263 Phone  
303-534-8266 Fax

|              |          |           |             |
|--------------|----------|-----------|-------------|
| Approved by: | MM/DD/YY |           |             |
| Drawn:       |          |           |             |
| File name:   |          | Scale 1:1 | Sheet 9-3-4 |

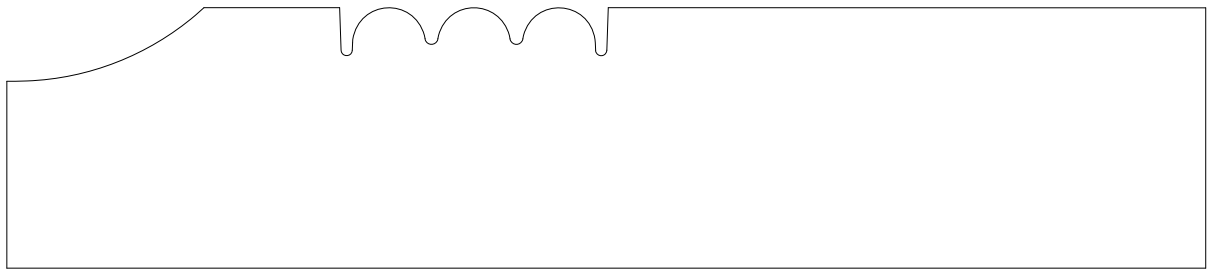

93029

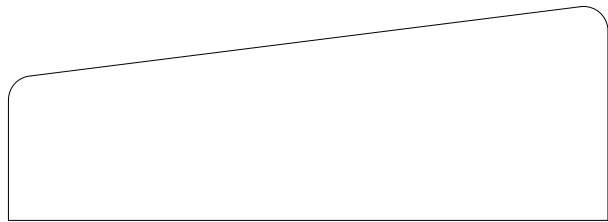

93030

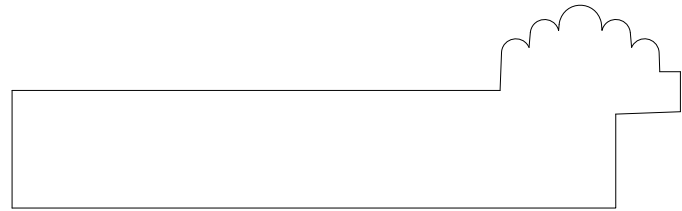

93033

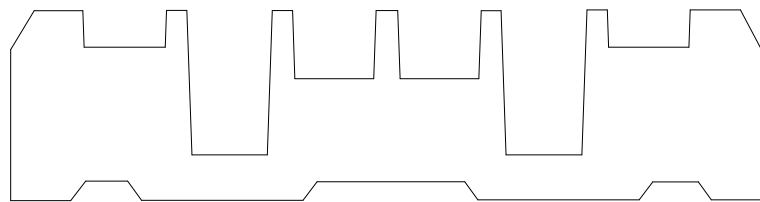

93031

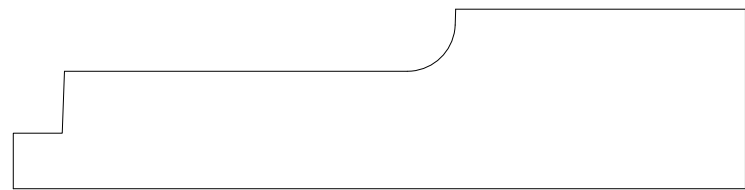

93034

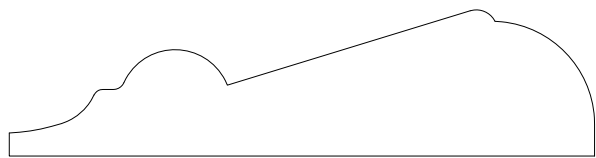

93032

EST. 1879

**S T A R K**

L U M B E R C O M P A N Y

FINE WOOD MOULDING

924 W. 1st. Avenue  
 Denver, CO 80223  
 303-534-8263 Phone  
 303-534-8266 Fax

|              |          |           |             |
|--------------|----------|-----------|-------------|
| Approved by: | MM/DD/YY |           |             |
| Drawn:       |          |           |             |
| File name:   |          | Scale 1:1 | Sheet 9-3-5 |

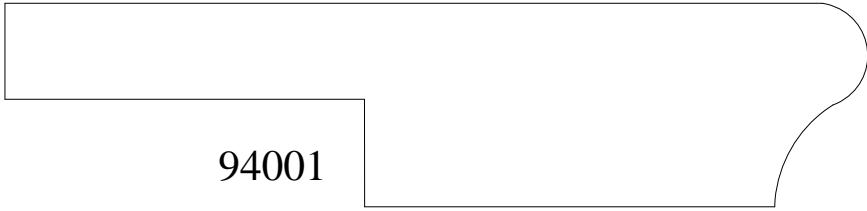

94001

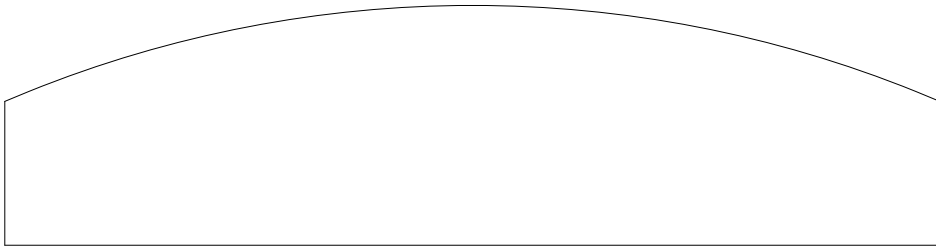

94002



94003

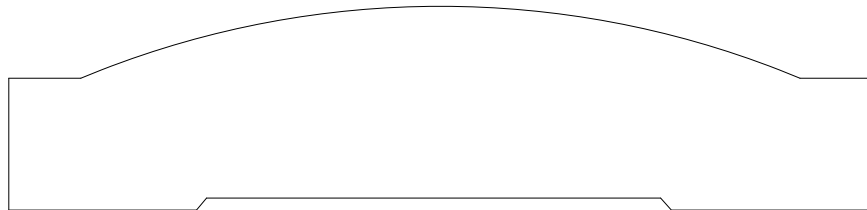

94004

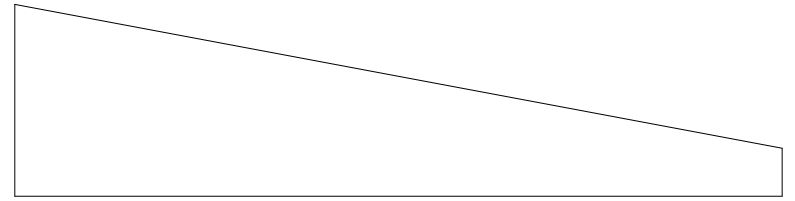

94005

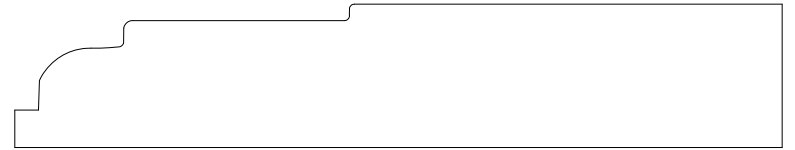

94006

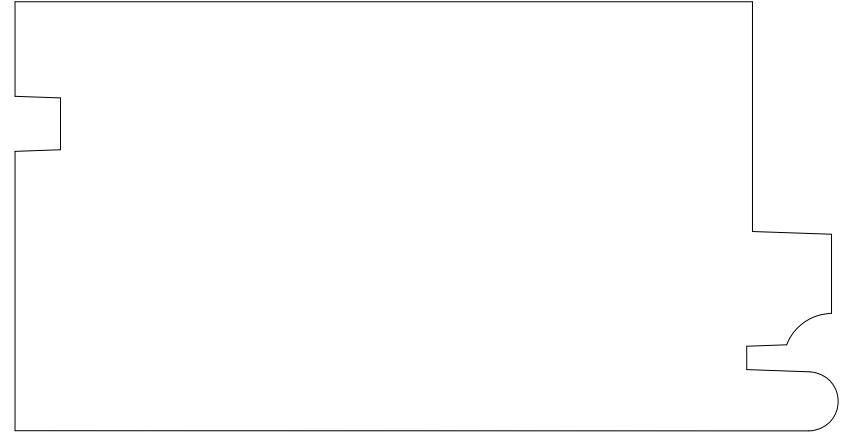

94007



94008



924 W. 1st. Avenue  
Denver, CO 80223  
303-534-8263 Phone  
303-534-8266 Fax

|              |          |  |           |             |
|--------------|----------|--|-----------|-------------|
| Approved by: | MM/DD/YY |  | Scale 1:1 | Sheet 9-4-1 |
| Drawn:       |          |  |           |             |
| File name:   |          |  |           |             |

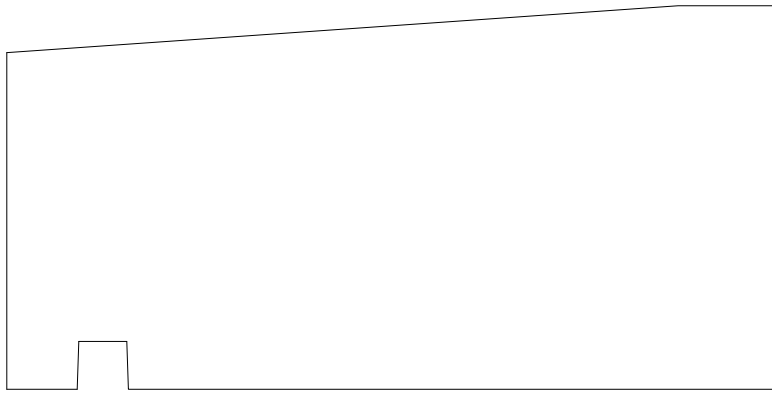

94009

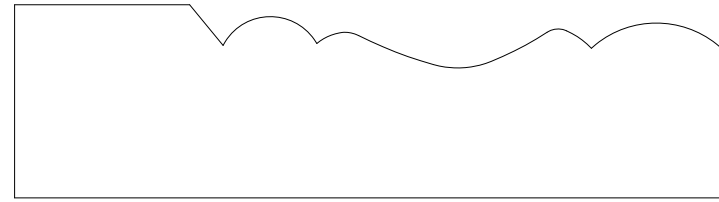

94013



94010

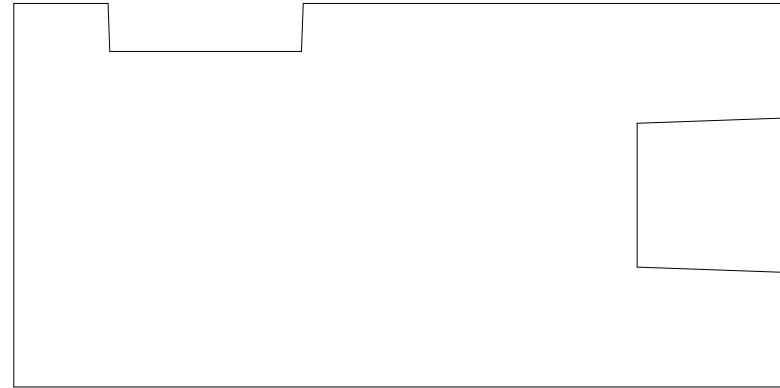

94014

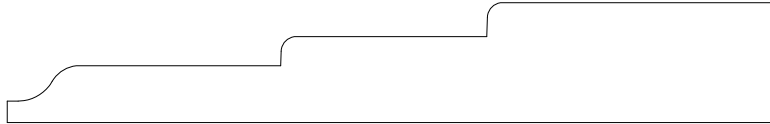

94011

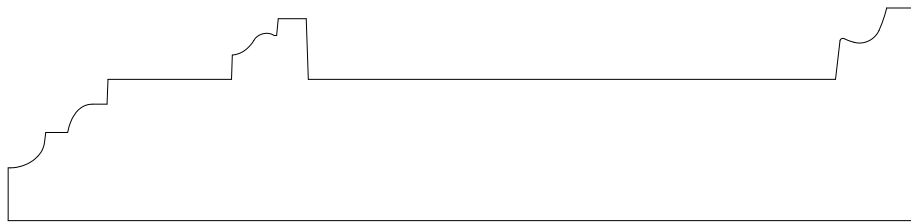

94012

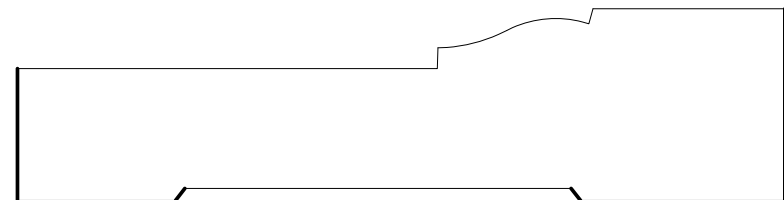

94015

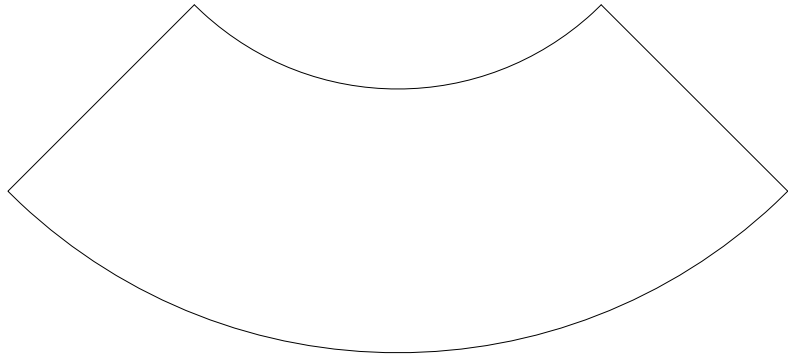

94016

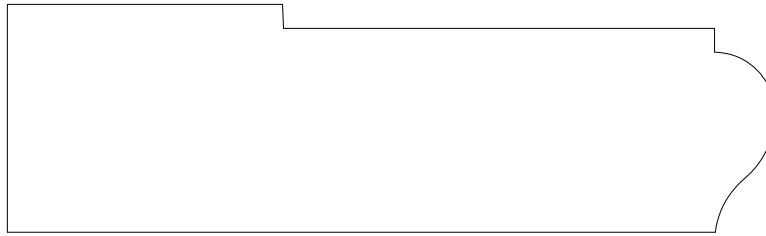

94021



94017



94022



94018



94023



94019

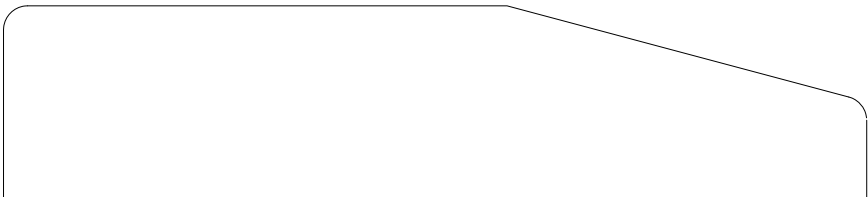

94036



94020



924 W. 1st. Avenue  
Denver, CO 80223  
303-534-8263 Phone  
303-534-8266 Fax

|              |          |           |             |
|--------------|----------|-----------|-------------|
| Approved by: | MM/DD/YY |           |             |
| Drawn:       |          |           |             |
| File name:   |          | Scale 1:1 | Sheet 9-4-3 |



95001



95002

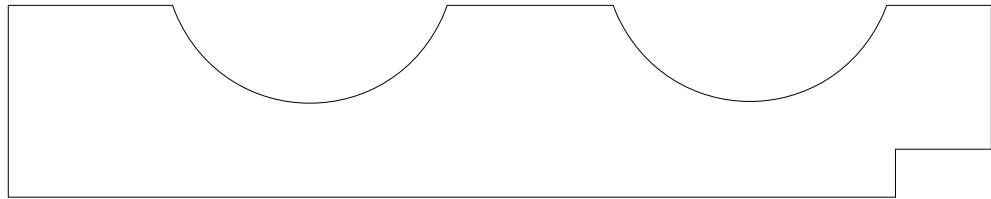

95003



95004



95005

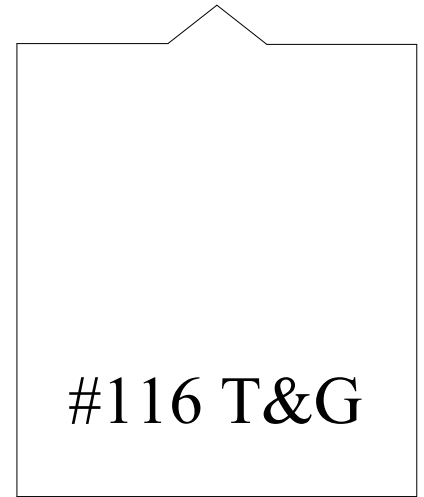

#116 T&G

95010



924 W. 1st. Avenue  
Denver, CO 80223  
303-534-8263 Phone  
303-534-8266 Fax

Approved by:

MM/DD/YY

Drawn:

File name:

Scale 1:1

Sheet 9-5-1



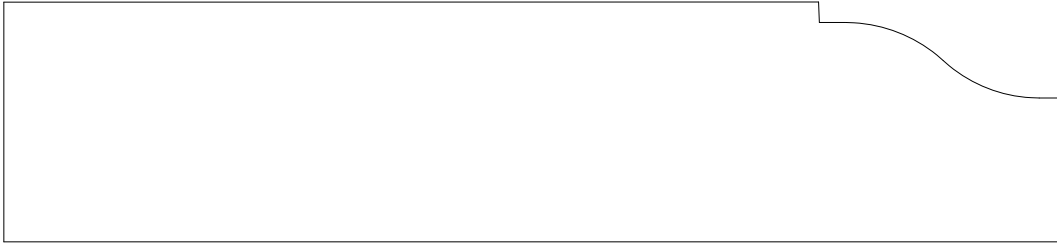

95006

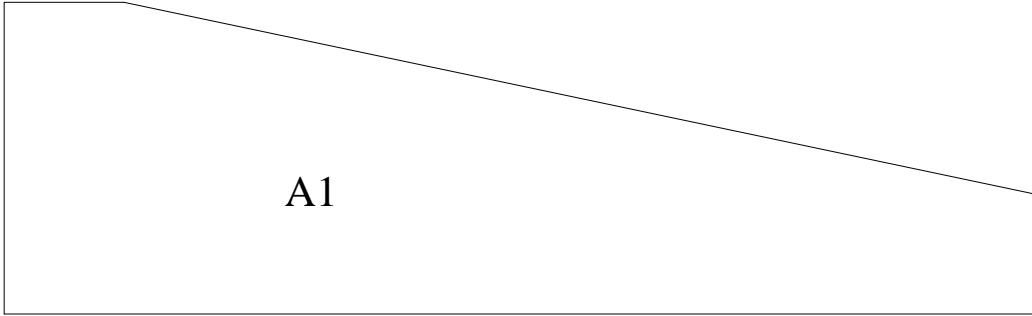

A1

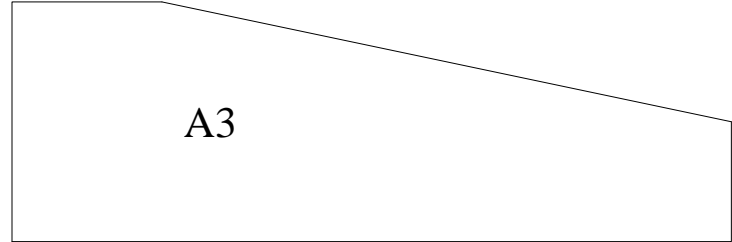

A3

95007

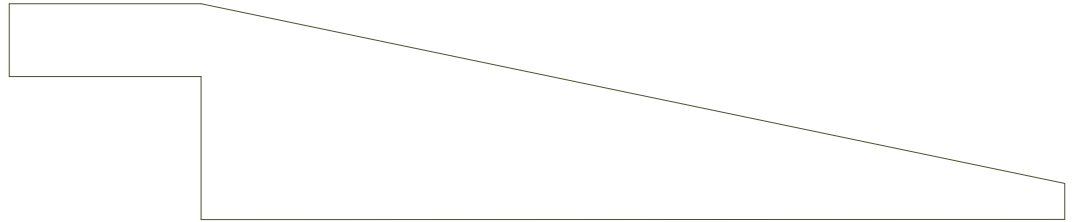

95013



95009

EST. 1879

**S T A R K**

L U M B E R C O M P A N Y

FINE WOOD MOULDING

924 W. 1st. Avenue  
 Denver, CO 80223  
 303-534-8263 Phone  
 303-534-8266 Fax

|              |          |           |             |
|--------------|----------|-----------|-------------|
| Approved by: | MM/DD/YY |           |             |
| Drawn:       |          |           |             |
| File name:   |          | Scale 1:1 | Sheet 9-5-2 |



95008

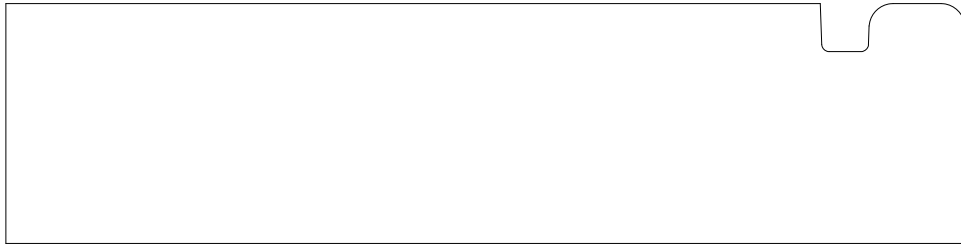

95011

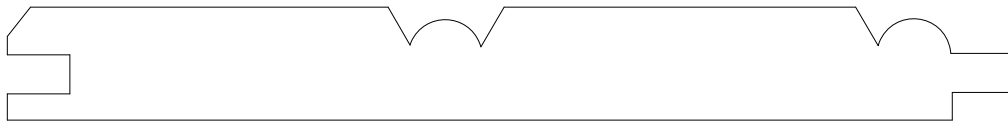

95017

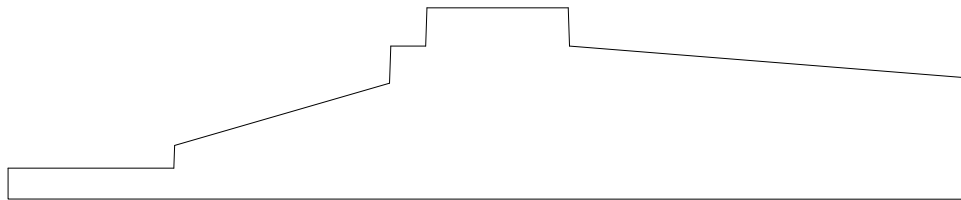

95018



95012

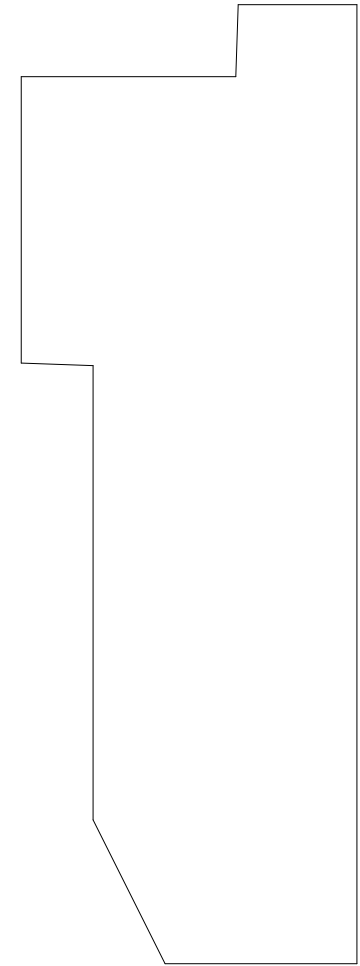

95014

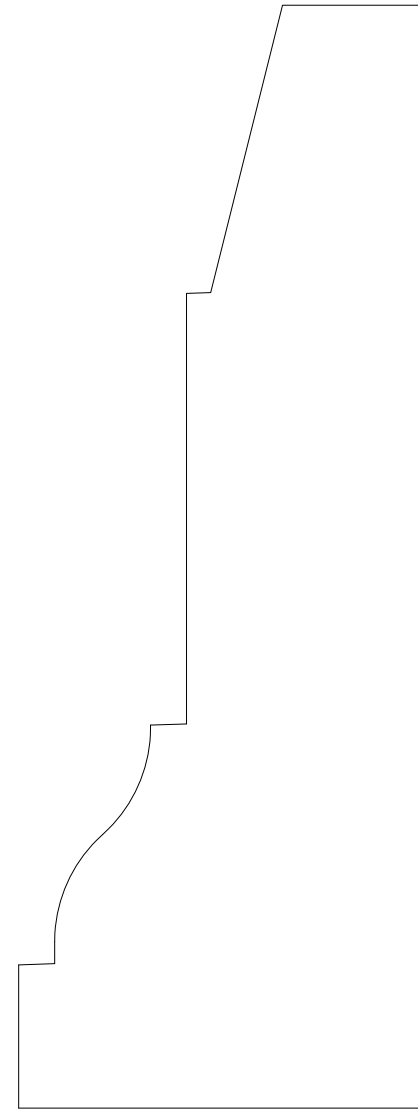
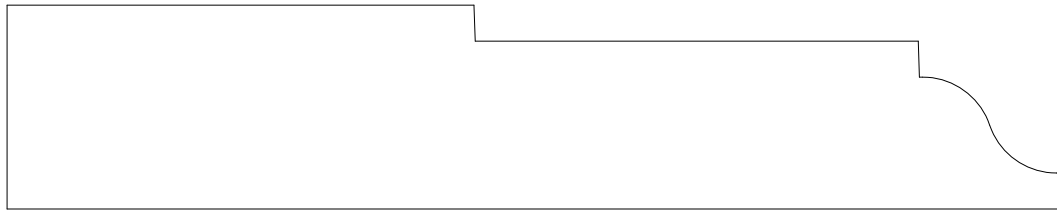
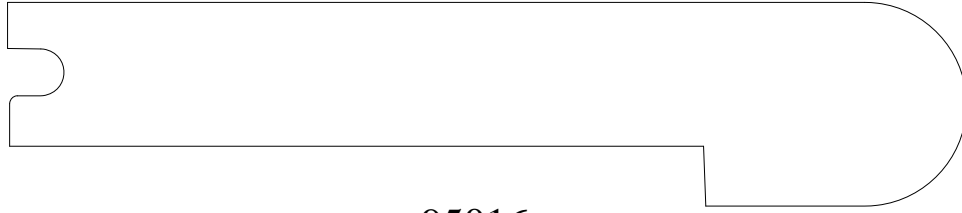
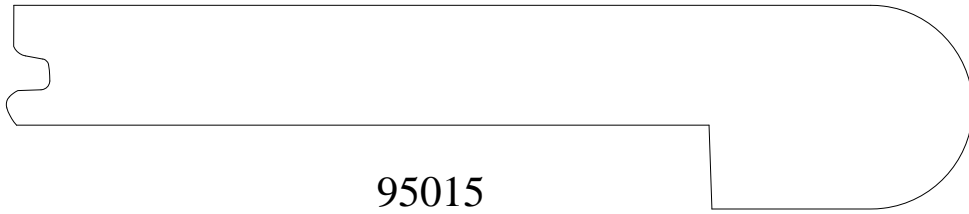

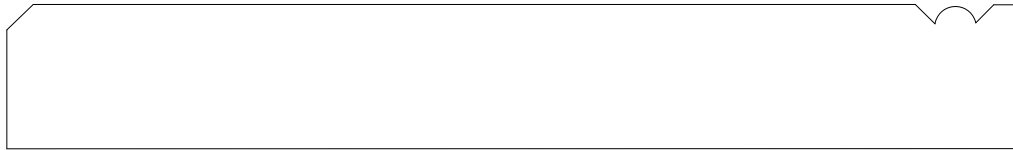

95030

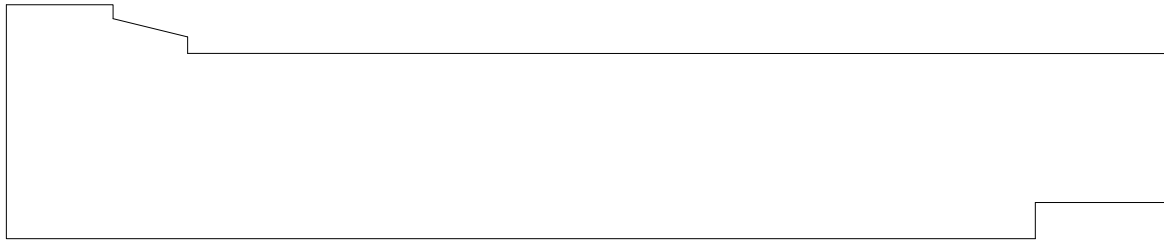

96001

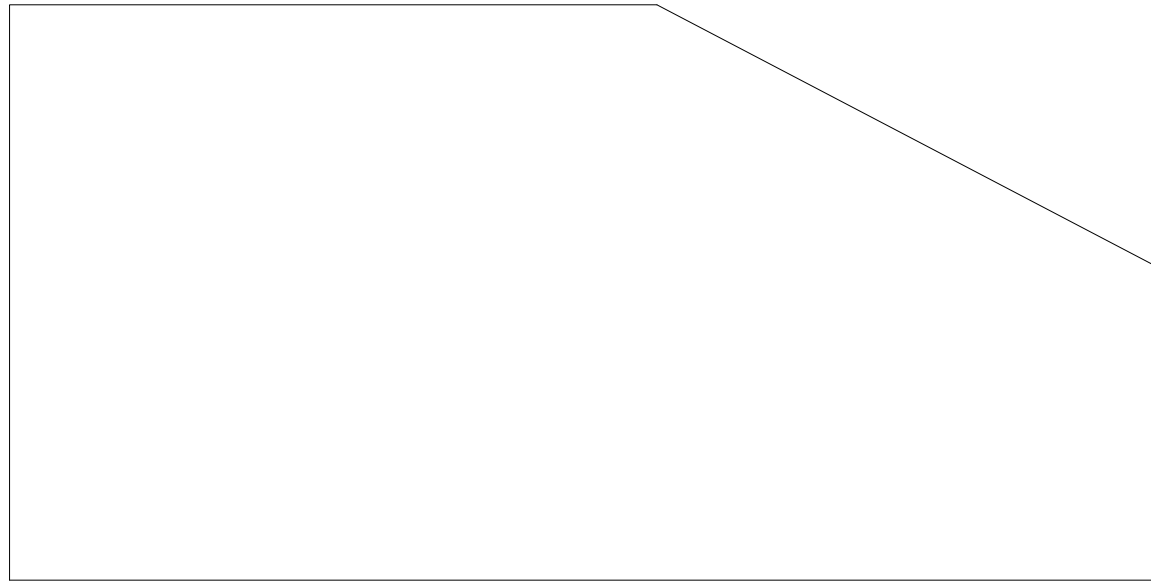

96002

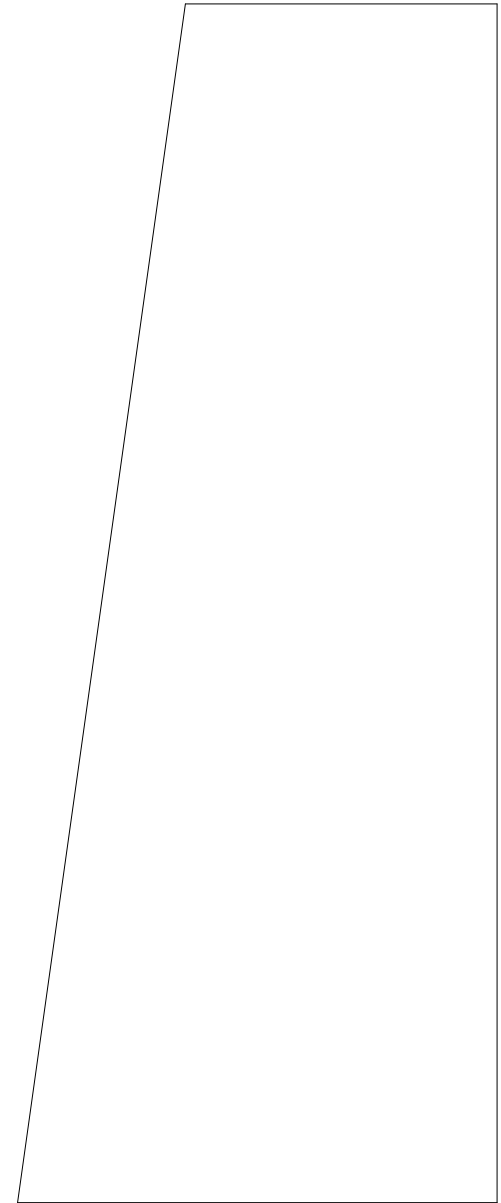

96003



924 W. 1st. Avenue  
Denver, CO 80223  
303-534-8263 Phone  
303-534-8266 Fax

|              |          |           |             |
|--------------|----------|-----------|-------------|
| Approved by: | MM/DD/YY |           |             |
| Drawn:       |          |           |             |
| File name:   |          | Scale 1:1 | Sheet 9-6-1 |

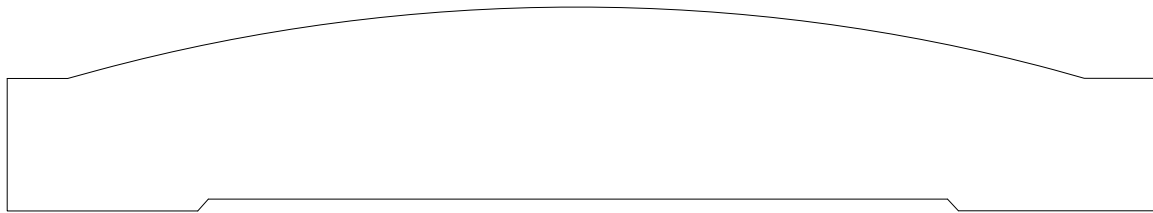

96004

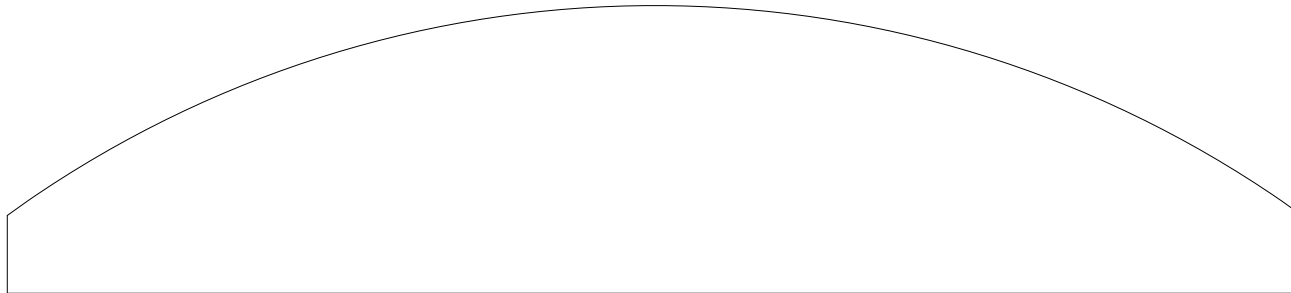

96007

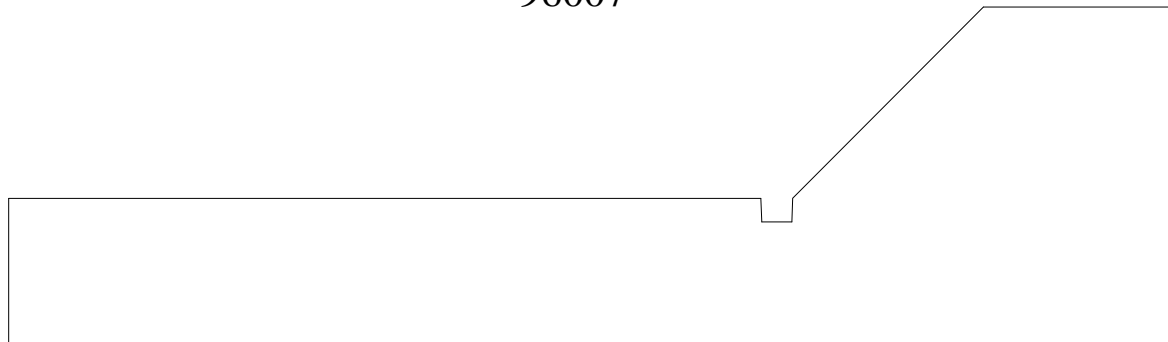

96008

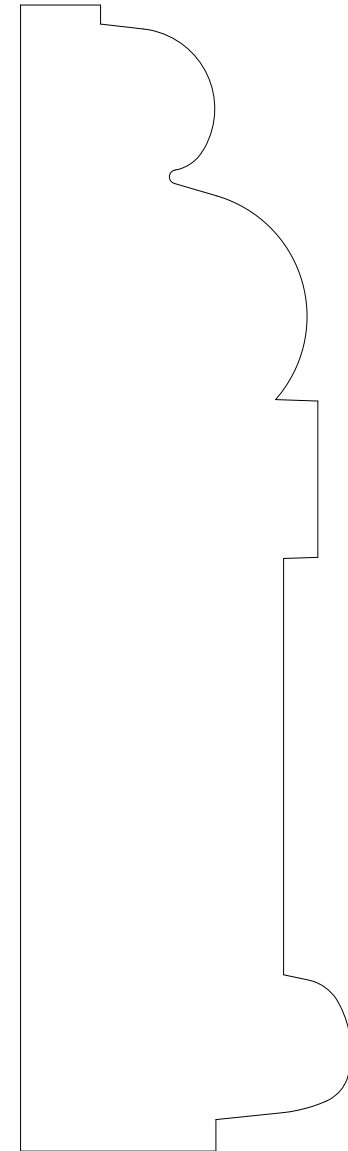

96009

EST. 1879

**S T A R K**

L U M B E R C O M P A N Y

FINE WOOD MOULDING

924 W. 1st. Avenue  
 Denver, CO 80223  
 303-534-8263 Phone  
 303-534-8266 Fax

|              |          |           |             |
|--------------|----------|-----------|-------------|
| Approved by: | MM/DD/YY |           |             |
| Drawn:       |          |           |             |
| File name:   |          | Scale 1:1 | Sheet 9-6-2 |



97001



97002

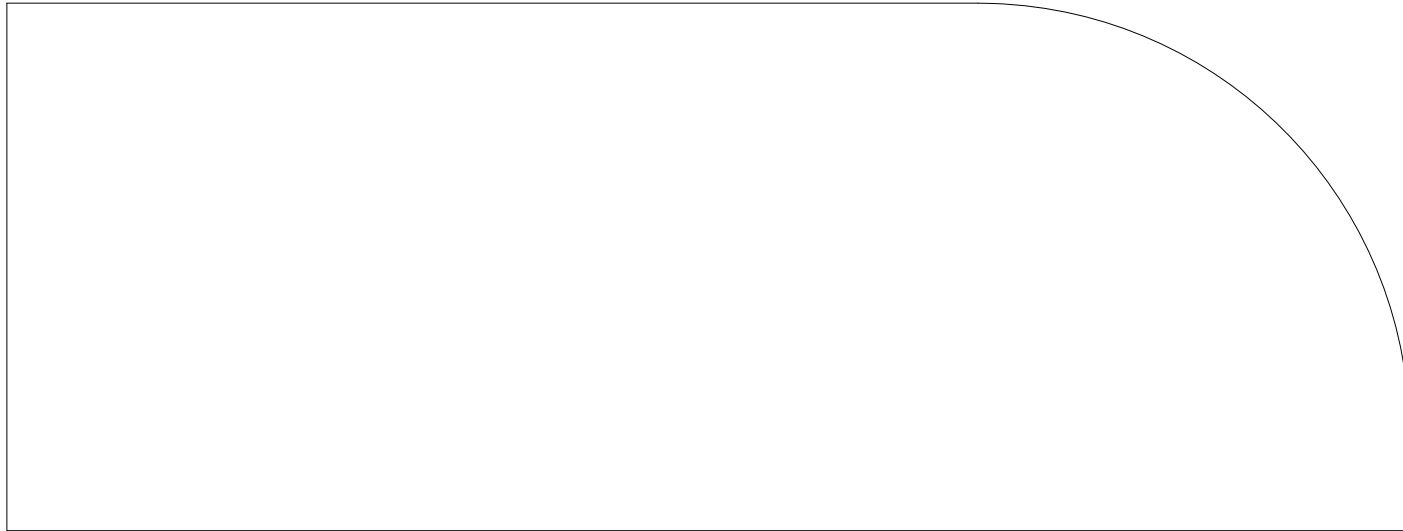

97003



97004

EST. 1879

**S T A R K**

L U M B E R C O M P A N Y

FINE WOOD MOULDING

924 W. 1st. Avenue  
 Denver, CO 80223  
 303-534-8263 Phone  
 303-534-8266 Fax

|              |          |             |
|--------------|----------|-------------|
| Approved by: | MM/DD/YY |             |
| Drawn:       |          |             |
| File name:   |          | Scale 1:1   |
|              |          | Sheet 9-7-1 |

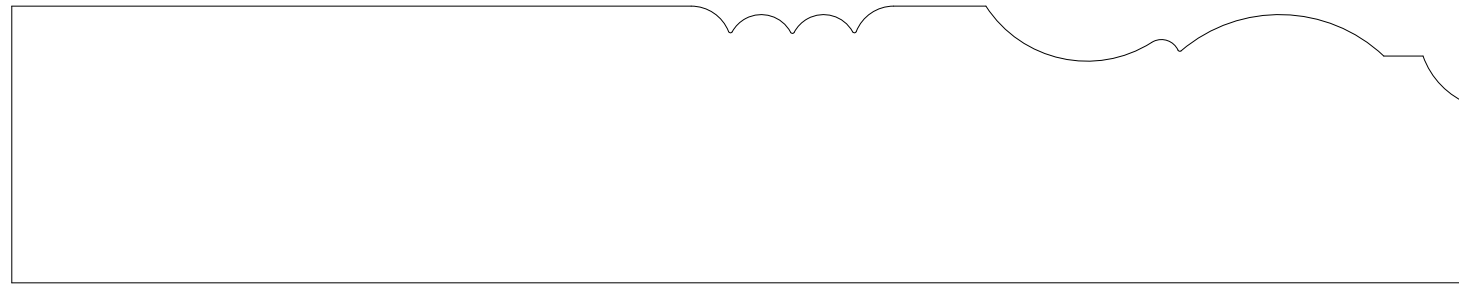

97005

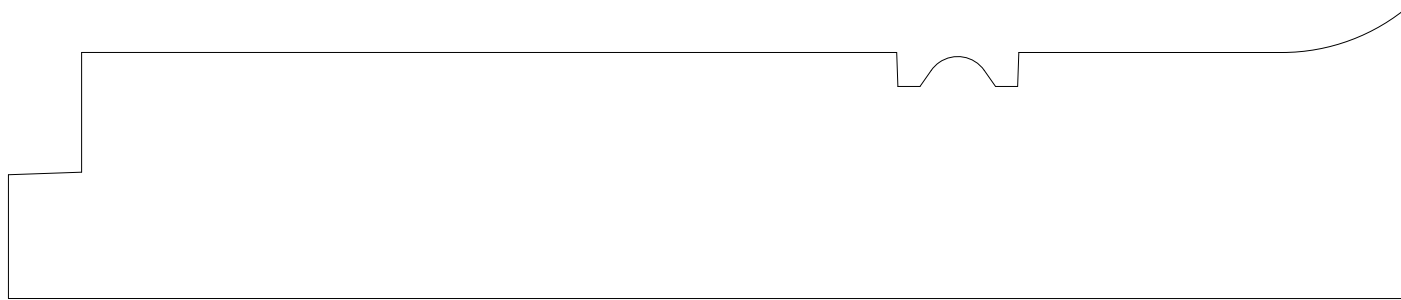

97006

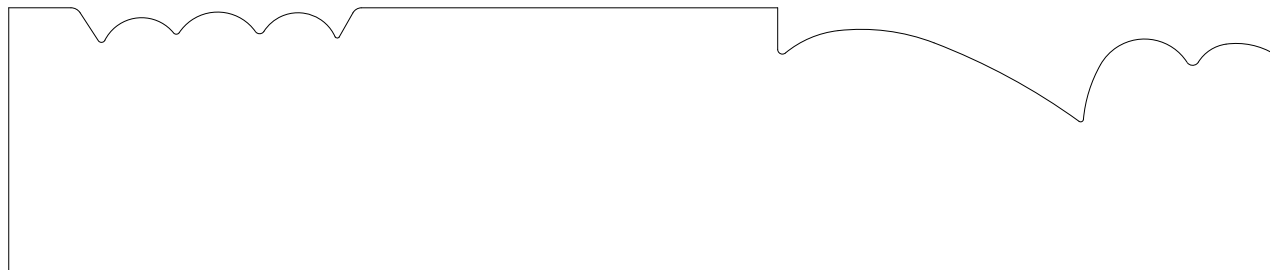

97008

|  |  |
|--|--|
|  | EST. 1879<br>924 W. 1st. Avenue<br>Denver, CO 80223<br>303-534-8263<br>Phone |
|  | 303-534-8266 Fax   |

|  |
|--|
|  |
|--|

|              |          |
|--------------|----------|
| Approved by: | MM/DD/YY |
| Drawn:       |          |
| File name:   |          |

|  |           |             |
|--|-----------|-------------|
|  | Scale 1:1 | Sheet 9-7-2 |
|--|-----------|-------------|

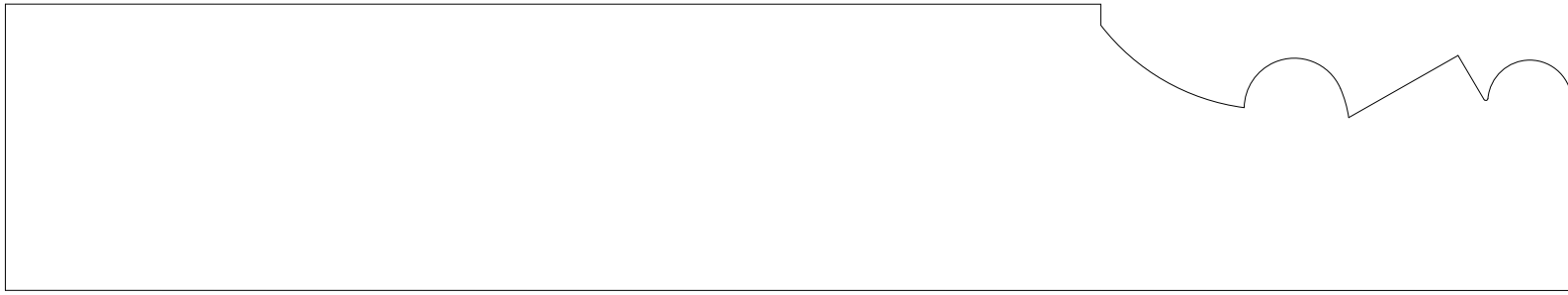

97027



97035

|  |   |
|--|---|
|  | 924 W. 1st. Avenue<br>Denver, CO 80223<br>303-534-8263<br>Phone |
|  | 303-534-8266 Fax  |

|  |
|--|
|  |
|--|

|              |          |
|--------------|----------|
| Approved by: | MM/DD/YY |
| Drawn:       |          |
| File name:   |          |

|           |             |
|-----------|-------------|
| Scale 1:1 | Sheet 9-7-3 |
|-----------|-------------|



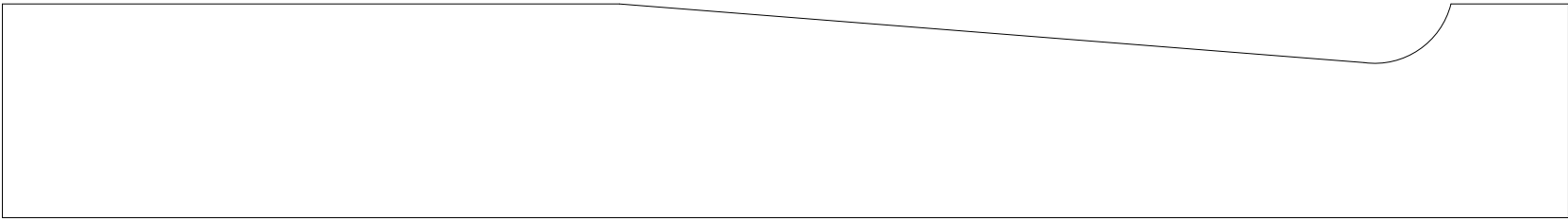

98001

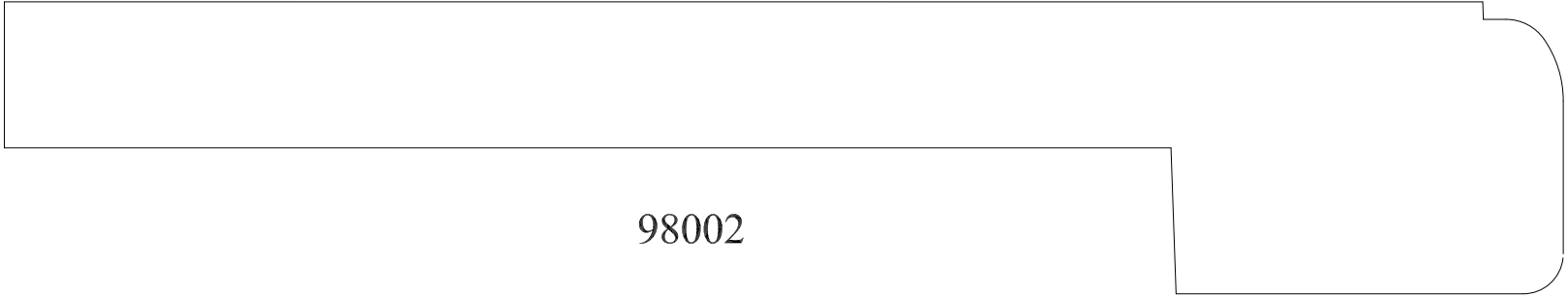

98002

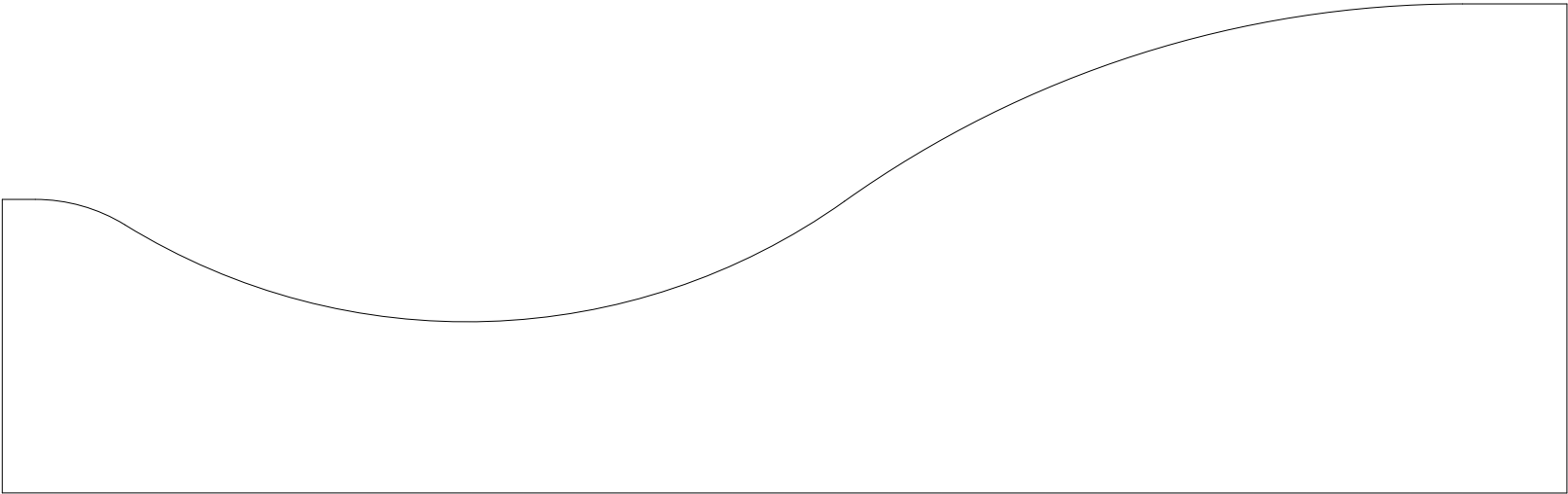

98003

|  |                    |
|--|--------------------|
|  | 924 W. 1st. Avenue |
|  | Denver, CO 80223   |
|  | 303-534-8263       |
|  | Phone              |
|  | 303-534-8266 Fax   |

|  |
|--|
|  |
|  |
|  |

|              |          |
|--------------|----------|
| Approved by: | MM/DD/YY |
| Drawn:       |          |
| File name:   |          |

|  |           |             |
|--|-----------|-------------|
|  | Scale 1:1 | Sheet 9-8-1 |
|--|-----------|-------------|

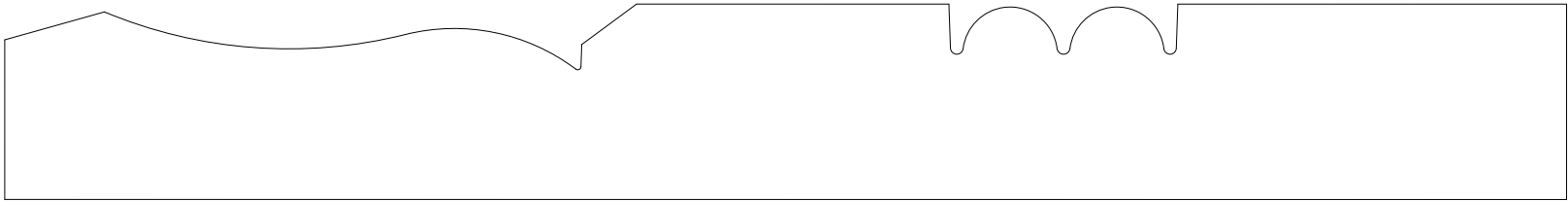

98040

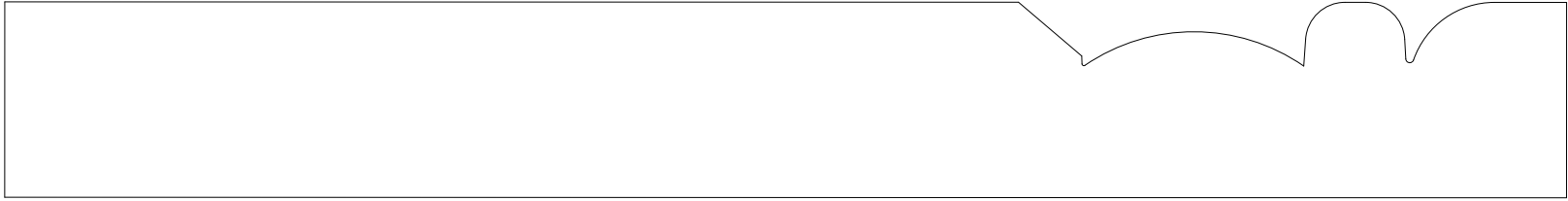

98041

|   |   |
|---|---|
|  <p>EST. 1879<br/><b>S T A R K</b><br/>L U M B E R C O M P A N Y<br/>FINE WOOD MOULDING</p> | 924 W. 1st. Avenue<br>Denver, CO 80223<br>303-534-8263<br>Phone |
|   | 303-534-8266 Fax  |

|  |
|--|
|  |
|--|

|              |          |
|--------------|----------|
| Approved by: | MM/DD/YY |
| Drawn:       |          |
| File name:   |          |

|           |             |
|-----------|-------------|
| Scale 1:1 | Sheet 9-8-2 |
|-----------|-------------|

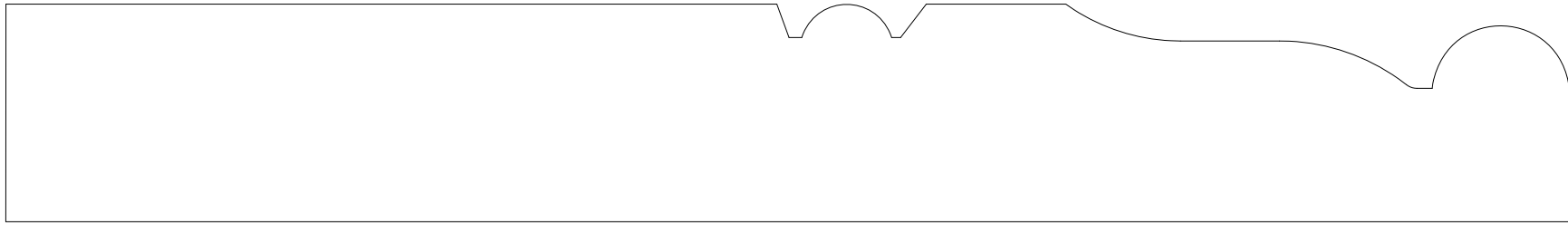

99001

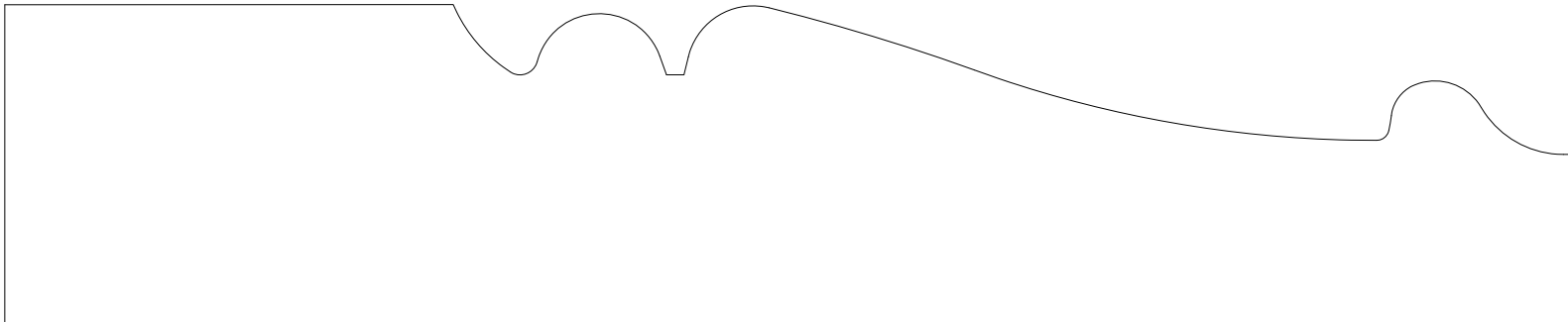

99002



99004



924 W. 1st. Avenue  
Denver, CO 80223  
303-534-8263 Phone  
303-534-8266 Fax

|              |          |           |             |
|--------------|----------|-----------|-------------|
| Approved by: | MM/DD/YY |           |             |
| Drawn:       |          |           |             |
| File name:   |          | Scale 1:1 | Sheet 9-9-1 |

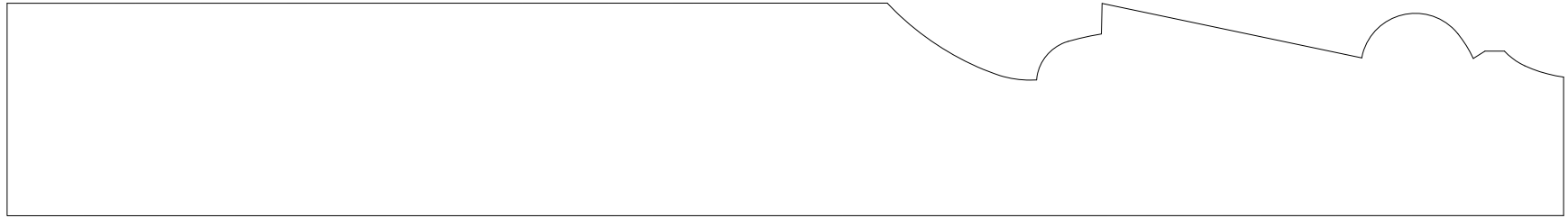

99005

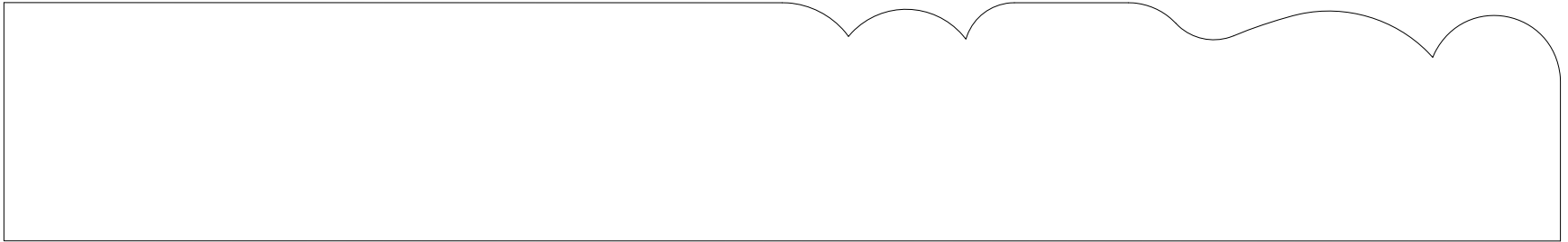

99006

|   |  |              |          |           |             |
|---|--|--------------|----------|-----------|-------------|
| <p>EST. 1879</p> <p><b>S T A R K</b></p> <p>L U M B E R C O M P A N Y</p> <p>FINE WOOD MOULDING</p> | <p>924 W. 1st. Avenue<br/>Denver, CO 80223<br/>303-534-8263 Phone<br/>303-534-8266 Fax</p> | Approved by: | MM/DD/YY | Scale 1:1 | Sheet 9-9-2 |
|   |  | Drawn:       |          |           |             |
|   |  | File name:   |          |           |             |

|              |          |           |             |
|--------------|----------|-----------|-------------|
| Approved by: | MM/DD/YY | Scale 1:1 | Sheet 9-9-2 |
| Drawn:       |          |           |             |
| File name:   |          |           |             |